

TOSHIBA

OWNER'S MANUAL

900MHz CORDLESS TELEPHONE DIGITAL ANSWERING SYSTEM

FT-8980



The **FIRST** thing to do after unpacking your new cordless telephone is:

CHARGE THE BATTERY !

Please read and follow the few instructions on

PAGE 2

BEFORE YOU DO ANYTHING ELSE.

Preparation

Basics

Caller ID/Call waiting

Answering system

Additional Information

GETTING STARTED: DO THIS FIRST!

FIRST,

- **Before you can take advantage of the Caller ID and Call Waiting features, you must subscribe to these services from your local telephone company.**
- Name and number caller ID only work in conjunction with service provided by your local telephone company.

SECOND, after unpacking your new cordless phone:

CHARGE THE HANDSET BATTERY!

- Set your new phone in an out-of-the-way place near a power outlet where it will not be disturbed.
- Plug the AC adaptor into the wall outlet.
- Plug the AC adaptor cord into the power jack on the base unit. The "POWER" LED should light. If not, see "**TROUBLESHOOTING**," page 49.
- Take the cover off the handset battery compartment; plug the battery connector into the receptacle inside the battery compartment and replace the cover. The connector only goes in one way.
- Place the handset into the base unit's charging cradle. The "CHARGE" LED should light.
- The battery charging period has now started. From now until the 12 hour period is complete, do not let anything cause the handset to be removed from electrical contact with the base unit's charging pins or power to be removed from the base unit.

THIRD, enter your Area code (see page 17), and set the clock (see page 18).

TABLE OF CONTENTS

Preparation

IMPORTANT SAFETY INSTRUCTIONS	5
INTRODUCTION	7
Features	7
Parts identification	8
LOCATION OF CONTROLS	9
Handset	9
Base unit	10
INSTALLATION	11
Setting up the base unit (Desk top mounting)	11
Setting up the base unit (Wall mounting)	12
Charging the battery pack	13
Setting the Tone/Pulse switch	14
Setting or canceling the Auto-talk function	15
Setting or canceling Caller ID on call waiting	16
Setting the area code	17
Setting the clock	18
Setting the PIN number	19
AC adaptor information	20

Basics

BASIC OPERATION	21
Making a call	21
Answering a call	22
Switching from the speakerphone to the handset	23
Out of range	23
Call waiting	23
Changing the ringer volume	24
Changing the speaker volume	25
Last number redial	26
Sending the tone signal	26
Paging the handset	27
Interference or static	27

TABLE OF CONTENTS

MEMORY DIALING28
Storing numbers28
Dialing a stored number30
Changing and deleting stored numbers31

Caller ID/Call waiting

CALLER ID/CALL WAITING33
Answering a call with caller ID service33
Call Waiting34
Searching caller ID memory35
Dial out36
Editing caller ID data37
Storing to speed dial memory38
Deleting caller ID data39

Answering system

USING THE ANSWERING MACHINE41
Turning the answering machine on & off41
Recording the outgoing message (OGM)42
To change the outgoing message (OGM)42
Setting the number of rings43
Setting the recording time43
Playing recorded messages44
Deleting recorded messages45
Screening incoming calls45
Leaving a memo message46
Recording a phone conversation (2WAY REC)46
Calling in from a remote location47
Table of commands48

Additional information

TROUBLESHOOTING49
WARRANTY/SERVICE51
WALL MOUNT TEMPLATE53
REMOTE OPERATION CARDS53

IMPORTANT SAFETY INSTRUCTIONS

When using your telephone equipment, basic safety precautions should always be followed to reduce the risk of fire, electric shock and injury.

Read and understand all instructions.

Follow all warnings and instructions marked on the product.

Unplug this product from the wall outlet before cleaning. Do not use liquid cleaners or aerosol cleaners. Use a dry cloth for cleaning.

Do not use this product near water sources, such as bath tubs, wash bowls, kitchen sinks, laundry tubs, wet basements, or swimming pools.

Do not place this product on an unstable cart, stand, or table. The telephone may fall, causing serious damage to the telephone.

Slots and openings in the cabinet and the back or bottom are provided for ventilation. To protect it from overheating, these openings must not be blocked or covered. The openings should never be blocked by placing the product on a bed, sofa, rug, or other similar surface. This product should never be placed near or over a radiator or heat register. This product should not be placed in a built-in installation unless proper ventilation is provided.

Do not allow anything to rest on the power cord. Do not locate this product where the cord can be stepped on or tripped over.

Do not overload wall outlets and extension cords as this can result in the risk of fire or electric shock.

9 Never push objects of any kind into this product through cabinet slots as they may touch dangerous voltage points or short out parts that could result in a risk of fire or electric shock. Never spill liquid of any kind on the product.

10 Do not disassemble this product. Opening or removing covers puts you at risk of electrical shock, and incorrect reassembly can cause shocks, sparks or other damage during subsequent use.

11 Take this product to a qualified service technician under any of the following conditions:

- A. When the power supply cord is damaged or frayed.
- B. If liquid has been spilled into the product.
- C. If the product has been exposed to rain or water.
- D. If the product does not operate normally according to the operating instructions. Adjust only those controls covered by this manual. Improper adjustment of other controls may result in serious damage to the unit or your home.
- E. If the product has been dropped or the cabinet has been damaged.
- F. If the product exhibits a distinct change in performance.

12 Do not use the telephone in the vicinity of a gas leak.

IMPORTANT SAFETY INSTRUCTIONS

The RBRC™ Seal



The RBRC™ Seal on the (easily removable) nickel-cadmium battery (contained in our product) indicates that Toshiba America Consumer Products, Inc. (TACP) is voluntarily participating in an industry program to collect and recycle these batteries at the end of their useful lives, when taken out of service within the United States. The RBRC™ program provides a convenient alternative to placing used nickel-cadmium batteries into the trash or municipal waste, which is illegal in some areas.

TACP's payments to RBRC™ make it easy for you to drop off the spent battery at local retailers of replacement nickel-cadmium batteries, or at authorized TACP product service centers. You may also contact your local recycling center for information on where to return the spent battery. Please call 1-800-8-BATTER for information on Ni-Cd battery recycling in your area. TACP's involvement in this program is part of its commitment to protecting our environment and conserving natural resources.

RBRC™ is a trademark of Rechargeable Battery Recycling Corporation.

CAUTION: TO REDUCE THE RISK OF FIRE OR INJURY TO PERSONS BY THE BATTERY, READ AND FOLLOW THESE INSTRUCTIONS.

BATTERIES

- 1 Use only the appropriate type and size battery pack specified in the instruction manual provided for this product.
- 2 Do not dispose of the battery pack in a fire. The cell may explode. Check with State and local codes for possible special disposal instructions.
- 3 Do not open or mutilate the battery pack. Released electrolytes are corrosive and may cause damage to the eyes or skin. It may be toxic if swallowed.
- 4 Exercise care in handling the batteries. Contact with conductive materials such as rings, bracelets and keys may cause the battery to short out, resulting in overheating which could burn.
- 5 Charge the battery pack provided with or identified for use with this product only in accordance with the instructions and limitations specified in the instruction manual provided for this product.
- 6 Observe proper polarity orientation between the battery pack and the battery charger.

ATTENTION: THE PRODUCT THAT YOU HAVE PURCHASED CONTAINS A RECHARGEABLE BATTERY. UNDER VARIOUS STATE AND LOCAL LAWS, IT MAY BE ILLEGAL TO DISPOSE OF THIS BATTERY INTO THE MUNICIPAL WASTE STREAM. PLEASE CHECK WITH YOUR LOCAL GOVERNMENT FOR DETAILS IN YOUR AREA REGARDING RECYCLING OPTIONS OR PROPER DISPOSAL.

SAVE THESE INSTRUCTIONS

TO HELP PROTECT THE ENVIRONMENT, THIS PRODUCT MAY CONTAIN RECYCLED OR RECONDITIONED PARTS AND MATERIALS.

INTRODUCTION

FEATURES

Shimada America Consumer Products Inc. takes pride in presenting the 900MHz cordless telephone and digital answering system. This all digital answering device provides many new conveniences not available on tape machines, such as repeat, skip and individual message delete.

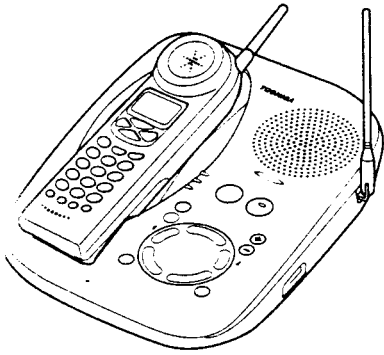

- 900 MHz analog transmission with extended talk range
- 40 channel auto scanning
- All digital recording system (approx. 15 min. recording time)
- Advanced compandor noise reduction system
- 50 name & number Caller ID - only works in conjunction with service provided by your local telephone company
- Digital duplex speakerphone
- Custom outgoing message (OGM)/Pre-recorded OGM
- Memo recording
- Caller ID on Call Waiting is available if both services are subscribed to and provided by your local telephone company
- Backlit 3-line alphanumeric LCD display
- Volume control (4 level)
- Digital security code (65,536 codes)
- Advanced message management design
- Voice guidance/Time stamp
- Long standby battery life(7 days)
- One way page/Handset locator
- Last number redial (32 digits)
- 10 speed dial (20 digits)
- Any-key answer
- Reversible charging system
- Hearing aid compatible/HAC volume
- Desk/Wall mountable (Bracket included)

INTRODUCTION

PARTS IDENTIFICATION

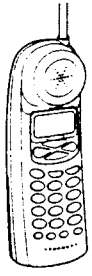

Handset

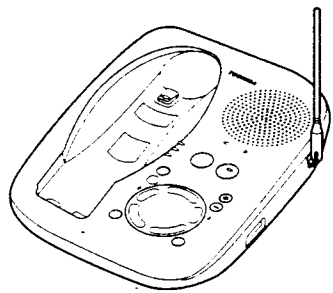

Base Unit

SUPPLIED ACCESSORIES:

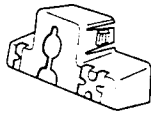

Wall Mount Bracket
Part #.RC009165

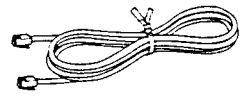

Modular Line Cord
Part #.RC008231

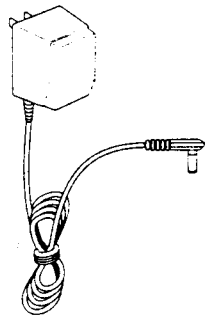

AC Adaptor TAC-8930
Part #.RC009255

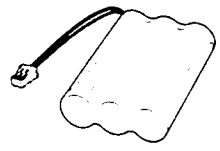

Rechargeable Battery Pack
Toshiba TRB-8000
Part #.RC004931

Owner's manual
Part #.RC009251

Quick Reference Guide
Part #.RC009244

For purchase of accessories, please call 1-877-644-7373.

LOCATION OF CONTROLS

HANDSET

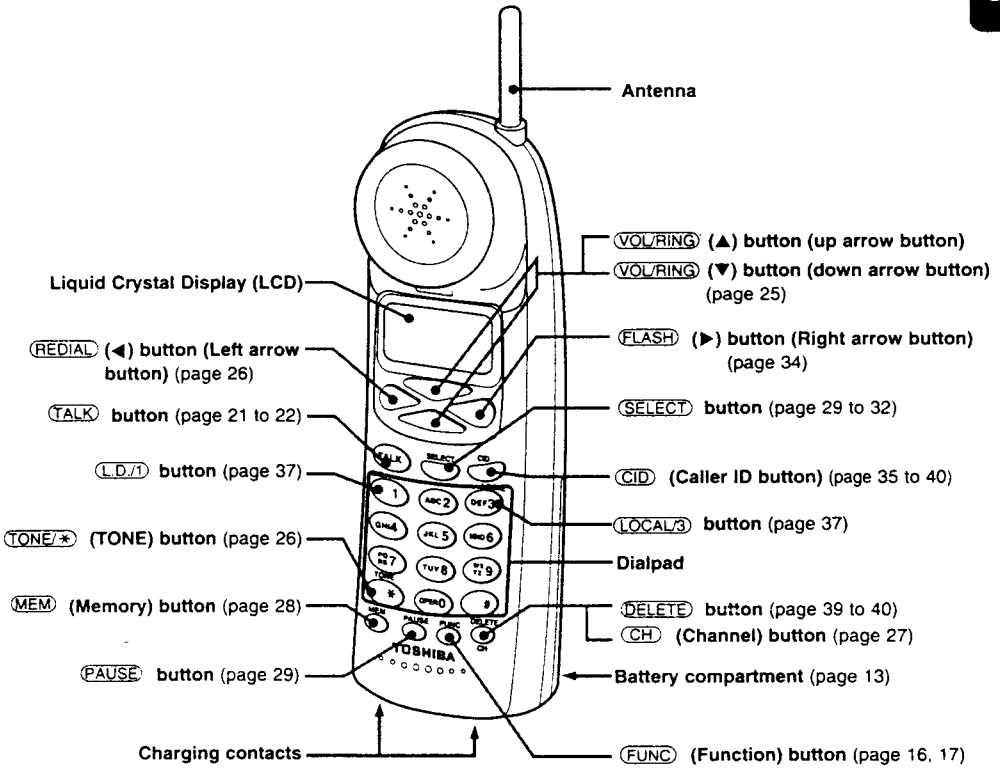

LOCATION OF CONTROLS

BASE UNIT

FRONT VIEW:

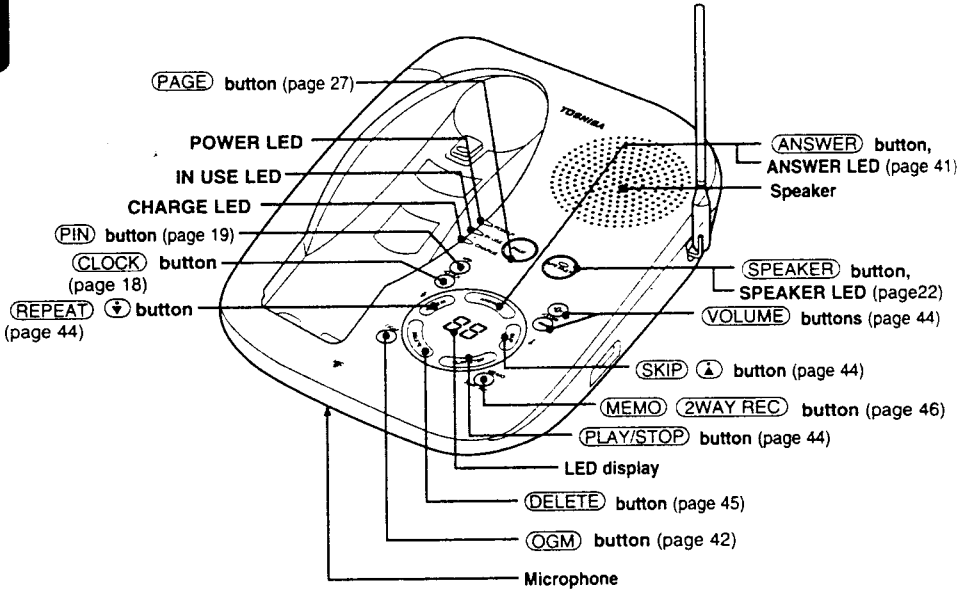

REAR VIEW:

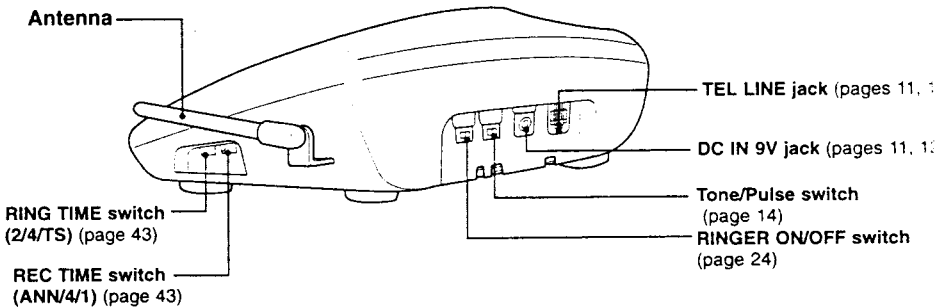

SETTING UP THE BASE UNIT (DESK TOP MOUNTING)

For setting up the base unit follow the instructions below.

DESK TOP INSTALLATION:

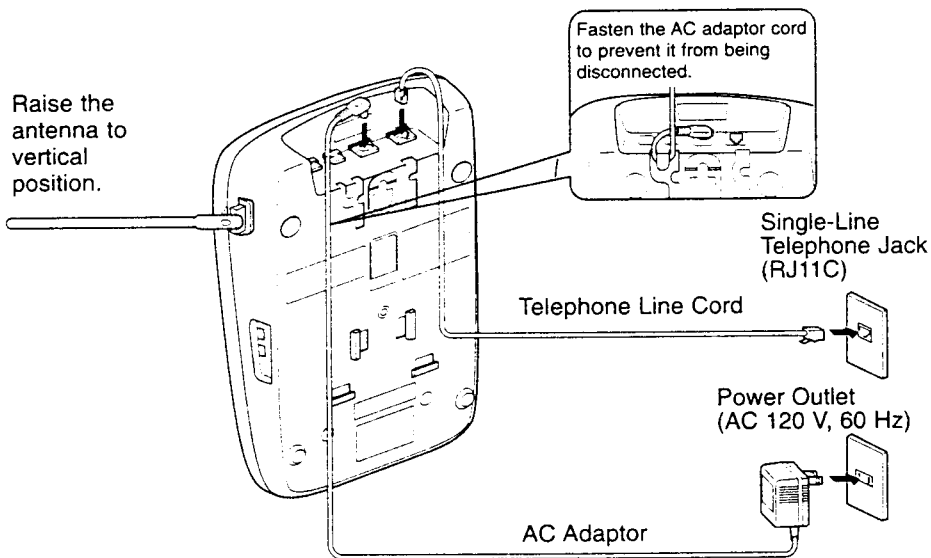

- USE ONLY WITH Supplied AC ADAPTOR.
- The AC adaptor must remain connected at all times. (It is normal for the adaptor to feel warm during use.)

NOTE:

Use only the supplied AC adaptor (TAC-8930; power source AC 120V 60Hz/DC9V), or one matching its specifications exactly, with this product. Incorrect voltage may damage the unit or cause it to function improperly.

INSTALLATION

SETTING UP THE BASE UNIT (WALL MOUNTING)

MOUNTING ON A STANDARD WALL PLATE:

Insert the bracket's tabs into the base's lower tab slots, then press down on the top of the bracket to snap it into the clip slots.

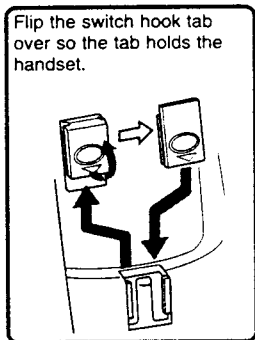
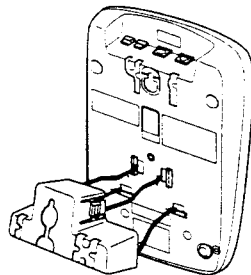

Raise the antenna.

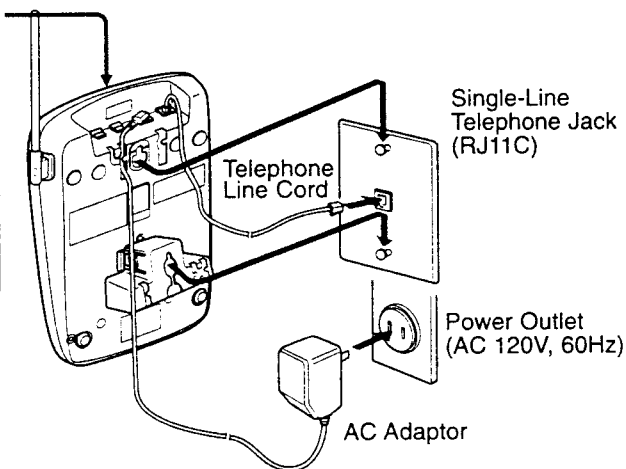

- Route the cords through the guides.
- Place the base unit on the posts of the wall plate and push down until it is firmly seated.
- **USE ONLY WITH Supplied AC ADAPTOR (TAC-8930; power source AC 120V, 60 Hz/DC 9V).**

NOTES:

- *Do not use any outlet controlled by a wall switch.*
- *If you don't have a standard wall plate, cut out the template on page 53 and use it to position two screws (minimum length of $1\frac{3}{8}$ inches) into the wall with the heads protruding about $1/4$ inch.*

INSTALLATION

CHARGING THE BATTERY PACK

1 Remove the battery compartment cover on the back of the handset by sliding it down.

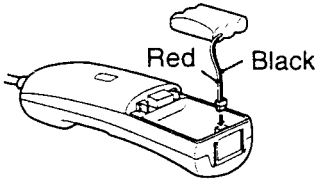

2 Plug the battery pack cord into the connector in the battery compartment by observing the correct polarity. It fits in only one way.

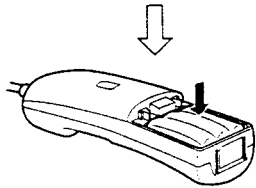

3 Place the battery pack in the battery compartment.

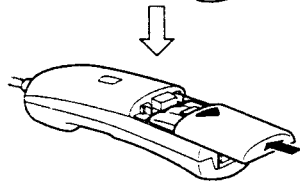

4 Put the battery compartment cover back by sliding until it snaps into place. Make sure not to get the wires of the battery pack caught in the cover.

5 Place the handset on the base unit. Be sure the CHARGE LED lights. If the CHARGE LED and POWER LED do not light, make sure the AC adaptor is plugged in securely and that the electrical outlet is working and not controlled by a light switch. **It is important to charge the battery for 12 to 16 hours continuously without any interruption before you use the handset for the first time.**

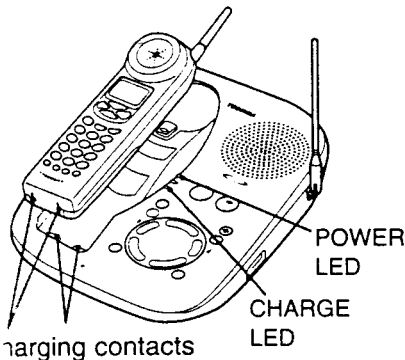

NOTES:

*Use only the supplied battery pack (TRB-8000; power source 600mAh, 3.6VDC)
The battery pack is not charged properly if the charging contacts are dirty or tarnished. Clean the contacts occasionally with a dry cloth.*

INSTALLATION

After the battery pack is fully charged;

Operation	Approx. battery life
While in use (Talk mode)	up to 7 hours
While not in use (Standby mode)	up to 7 days

When "Low Battery" blinks on the LCD, all handset buttons are disabled and the battery needs to be charged. If this occurs during a call, you hear short beeps. Finish the call as soon as possible and place the handset on the base unit.

Low Battery

NOTE:

If a call comes in when the battery is too low to operate properly, you will be unable to answer the call or the call will be disconnected.

SETTING THE TONE/PULSE SWITCH

Set the TONE/PULSE switch to TONE.

If the call does not connect with the TONE setting, set the TONE/PULSE switch to PULSE.

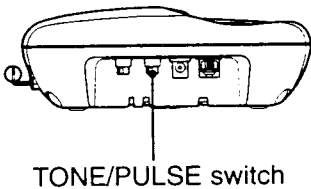

INSTALLATION

SETTING OR CANCELING THE AUTO TALK FUNCTION

When the handset is placed on the base unit, you can answer a call by simply lifting the handset from the base unit (Auto Talk). If the handset is not on the base unit, you can answer a call by pressing any one of the function buttons (Any-key Answer function). When the Auto Talk function is set to ON, the Any-key Answer function is also set to ON.

When the Auto Talk function is set to OFF, you can lift the handset and see the caller ID information before choosing to answer. This function is preset to OFF at the factory prior to shipment.

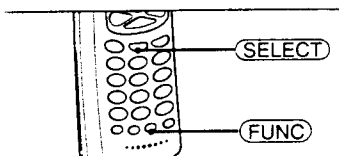

Press **(FUNC)**. The LCD displays the current setting.

```
1▶Auto Talk:Off
2 CIDCW      :0n
3 Area Code:
```

Press **(SELECT)**. Each time you press **(SELECT)**, the On/Off setting will be switched.

Press **(FUNC)**. The handset is put in standby mode.

```
1▶Auto Talk:On
2 CIDCW      :0n
3 Area Code:
```

INSTALLATION

SETTING OR CANCELING CALLER ID ON CALL WAITING

This function is preset to ON at the factory so that you will receive caller ID on Call Waiting when subscribing to both local telephone company services.

If you do not subscribe to these services, be sure to set this function to OFF.

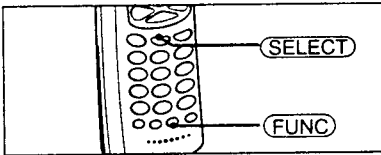

- 1** Press **(FUNC)**. The LCD displays the current setting.

1	▶Auto Talk:Off
2	CIDCW :On
3	Area Code:

- 2** Press **(▼)** or **(3)** to move the pointer to CIDCW and press **(SELECT)**. Each time you press **(SELECT)**, the On/Off setting will be switched.

1	▶Auto Talk:Off
2	▶CIDCW :On
3	Area Code:

- 3** Press **(FUNC)** and replace the handset on the base unit.

INSTALLATION

SETTING THE AREA CODE

It is necessary to program your area code so that local calls will be properly displayed on caller ID.

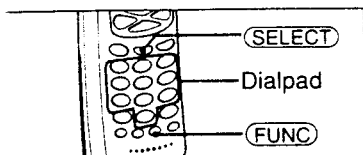

1 Press **(FUNC)**. The LCD displays the following message.

```
1▶Auto Talk:Off
2 CIDCW      :0n
3 Area Code:
```

2 Press **(↓)** or **(←)** to move the pointer to Area Code.

```
1 Auto Talk:Off
2 CIDCW      :0n
3▶Area Code:
```

3 Press **(SELECT)**.

```
1 Auto Talk:Off
2 CIDCW      :0n
3 Area Code:615
```

Enter a 3-digit area code. For example, enter "615."

If you enter a wrong number, press **(DELETE)**.

4 Press **(SELECT)**. A confirmation beep sounds. The LCD displays the following message.

```
1 Auto Talk:Off
2 CIDCW      :0n
3▶Area Code:615
```

5 Press **(FUNC)**. The handset is put in standby mode.

NOTES:

- Change your area code when you move to another location that has a different area code.
- When you make a call to a number within your area code, only the last 7 digits of the number are dialed. During call-back, however, the phone will include the area code from where the call originated when it automatically redials the number. To avoid this problem, always be sure to set the area code of your phone so that the phone will automatically exclude the area code when the incoming code is the same as that of the phone.

INSTALLATION

SETTING THE CLOCK

The answering machine announces the day and time that each message was recorded during a play back.

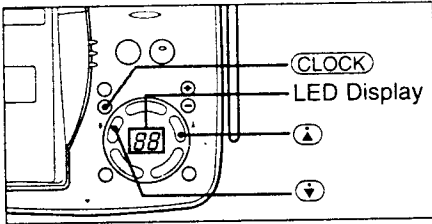

- 1** Press and hold **CLOCK** till a beep sounds.
- 2** Select the day of the week by pressing **↑** or **↓**. When the correct day is announced (corresponding to the number on the LED display), press **CLOCK**.
- 3** Select the Hour by pressing **↑** or **↓**. When the correct number (1 - 12) appears on the LED display, press **CLOCK**.
- 4** Select the Minute by pressing **↑** or **↓**. When the correct number (0 to 59) appears on the LED display, press **CLOCK**.
- 5** Select AM/PM by pressing **↑** or **↓**. At the correct display (A or P), press **CLOCK**.

You hear a long beep and the new day and time.

NOTES:

- You can hear the time currently set by pressing **CLOCK**.
- If you do not complete the setting procedure within 2 minutes, the setting procedure is cancelled.

SETTING THE PIN NUMBER

access your answering machine when you are away from home, you need to identify yourself with a Personal Identification Number (PIN). You can select any two digit number between 00 and 99 as your

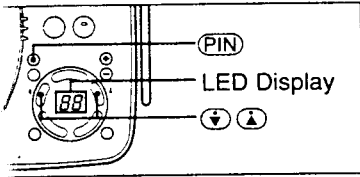

- 1 Press and hold **(PIN)** till a beep sounds. The LED display shows 00.
- 2 Press **(▲)** or **(▼)** to select the left digit of the PIN.
- 3 When your desired number appears on the LED display, press **(PIN)**.
- 4 Press **(▲)** or **(▼)** to select the right digit of the PIN.
- 5 When your desired number appears on the LED display, press **(PIN)**. The new PIN you entered will be announced.

NOTE:

You can check the current PIN by pressing **(PIN)** at anytime.

INSTALLATION

AC ADAPTOR INFORMATION

Use only the supplied AC adaptor, or one matching its specifications exactly, with this product. Incorrect voltage may damage the unit or cause it to function improperly.

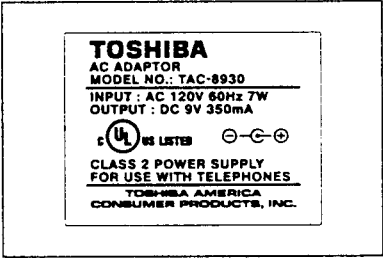

BASIC OPERATION

MAKING A CALL

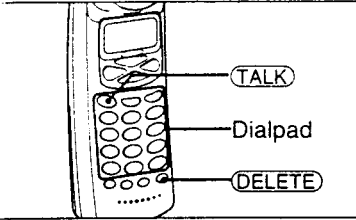

- 1 Pick up the handset and key-in the phone number (max. 32 digits). The LCD displays the entered numbers.

1234567890123456 789

NOTE:
To delete a wrong number, press **DELETE**. To delete all numbers, press and hold **DELETE**.

- 2 Press **TALK**. The LCD displays the current selected speaker volume level for 2 seconds.

Talk <Medium>

- 3 When the call is made, the LCD displays the entered digits. Then, you may begin speaking.

Talk 0:00 1234567890123456 789

After about 5 seconds, the LCD displays the duration of the call.

- 4 To hang up, press **TALK** or place the handset on the base unit.

BASIC OPERATION

ANSWERING A CALL

HANDSET:

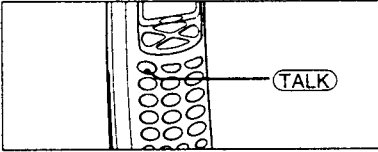

- 1 When a call is received, the phone rings and the LCD displays as shown.

Incoming call

- 2 Pick up the handset and press **TALK** to connect.

Talk 0:00
<Medium>

"Talk" and the volume setting appears on the LCD.

- 3 To hang up, press **TALK** or place the handset on the base unit.

12:35

BASE UNIT:

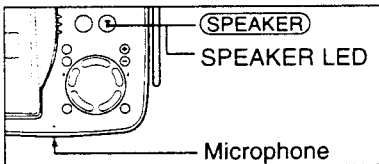

- 1 When you hear the phone ring, press **SPEAKER** to connect. The SPEAKER LED will light. Speak clearly close to the microphone.

- 2 To hang up, press **SPEAKER**.

BASIC OPERATION

SWITCHING FROM THE SPEAKERPHONE TO THE HANDSET

switch to the handset while you are using the base unit speakerphone, pick up the handset from the base unit. Then you can continue talking with the handset.

OUT OF RANGE

During a call, as you begin to move too far from the base, the noise increases. Then you should move close to the base unit. If you travel out-of-range, your call terminates.

CALL WAITING

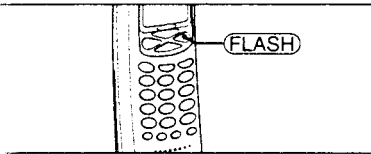

To use this feature, you must subscribe to the Call Waiting Service.

- 1 When you hear a call-waiting tone while you are already talking on the phone, simply press **FLASH**.
- 2 To take the original call back, press **FLASH** again.

NOTE:

Pressing **FLASH** without receiving a Call Waiting signal may disconnect the current caller.

BASIC OPERATION

CHANGING THE RINGER VOLUME

HANDSET:

Use the following procedure to set the ringer volume of the handset as desired.

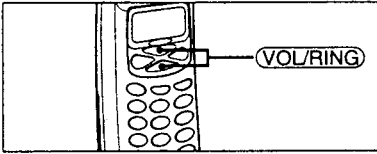

Pick up the handset and press **VOL/RING** to select one of four ringer tone and volume combinations.

Each time you press **VOL/RING** (**▼** or **▲**), the LCD will display the setting and the phone will ring using the selected ringer.

BASE UNIT:

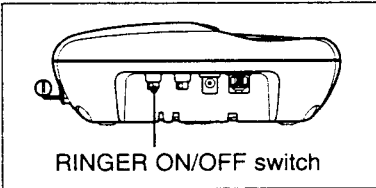

You can turn the ringer sound on or off by sliding the RINGER ON/OFF switch on the base unit.

NOTE:

When the handset is on the base unit, only the ringer of the handset will sound.

BASIC OPERATION

CHANGING THE SPEAKER VOLUME

HANDSET:

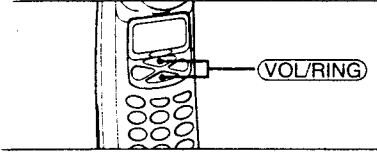

During a telephone call, press **VOL/RING** to select one of four speaker volume levels: Loud, High, Medium or Low. Each time you press **VOL/RING** (**▼** or **▲**), the LCD will display the setting.

NOTE:

The volume setting Loud may be too loud because it is set for hearing aid compatibility.

BASE UNIT:

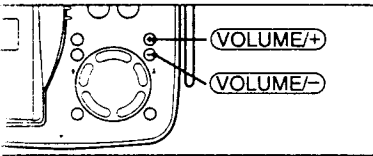

Press **VOLUME/+** or **VOLUME/-** to adjust the speaker volume while speaking. The volume level 1 to 10 is displayed.

BASIC OPERATION

LAST NUMBER REDIAL

To redial the last number that you called (up to 32 digits):

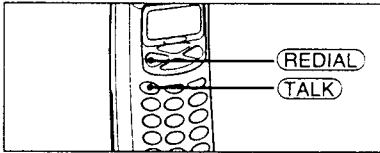

- 1** Press **REDIAL** during standby mode. The last number dialed appears on the LCD.
- 2** Press **TALK**. Then the number will be dialed.

SENDING THE TONE SIGNAL

Even if you have PULSE service (the TONE/PULSE switch is set to Pulse), you can use this phone with banking and other phone services requiring touch tone signals.

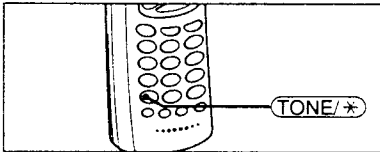

- 1** Dial the service number and wait for the connection.
- 2** Press **TONE/***, then enter the numbers required. You will hear the tones on the line.

BASIC OPERATION

PAGING THE HANDSET

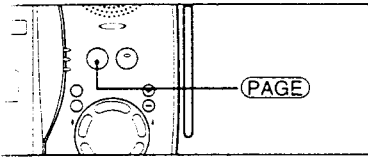

To locate the handset while it is off the base, press **(PAGE)**. The handset beeps for 30 seconds and the LCD displays the following message:

To stop paging, press **(PAGE)** or **(TALK)** twice, or return the handset to the base unit.

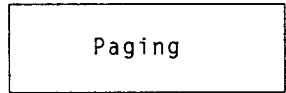

NOTE:
You cannot page the handset during a call.

INTERFERENCE OR STATIC

If you hear noise during a call, press **(CH)** to select another channel. The LCD displays "Scanning" while changing a channel.

MEMORY DIALING

You can store up to 10 telephone numbers and their associated names in the memory.

You can program them yourself or transfer them from the Caller ID memory.

NOTES:

- Always press a button within 20 seconds after pressing the previous button. Otherwise, the setting procedure will be canceled and the handset is put in standby mode.
- If you press a wrong button, an error tone sounds and the handset returns to standby mode.
- If you receive an incoming call or a pager call from the base unit during the operation, the operation will be cancelled.

STORING NUMBERS

You can store up to 20 digits including #, *, and PAUSE as a telephone number, and up to 14 characters as a name in one memory address.

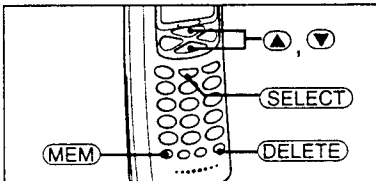

- 1** Pick up the handset and press and hold **MEM** till a beep sounds.

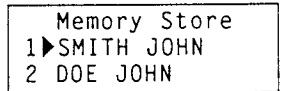

The LCD displays the memory dial list beginning the location number 1.

- 2** Enter a number (0-9), or press **▼**, **▲** to select a free memory location number.

Example: Selecting memory location number 7

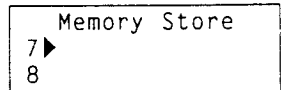

- 3** Press **SELECT**. The LCD displays the following screen.

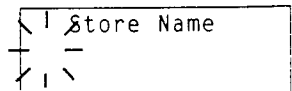

MEMORY DIALING

1 Enter a name of up to 14 characters.

Press or repeatedly to enter a space, alphanumeric characters: a space → A → B → ... → Y → Z → a → b → ... y → z → 0 → 1 → 2 ... 9 → * → # → - → & → (→) → a space → A → ...

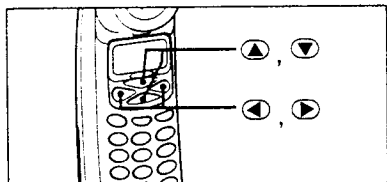
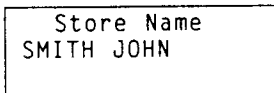

To enter the next character, press .
To move the cursor to the left, press .
Or, you can press **DELETE** to delete the entered character.

5 Press **SELECT**. The LCD displays the following screen.

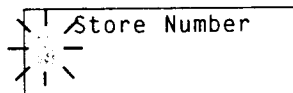

6 Enter a telephone number to be stored.

Example: Enter "1 PAUSE 1234567890."

NOTE:

By pressing **PAUSE**, you can insert a 2-second pause in the memory dial to make a long distance call or call through a PBX.

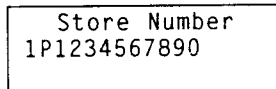

7 Press **SELECT**. A confirmation beep sounds and the number is stored.

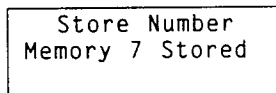

8 The LCD returns to Memory Store screen. To store more name and numbers, return to step 2. To finish the operation, press **MEM** or return the handset to the base unit.

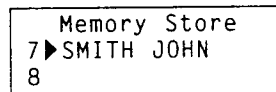

MEMORY DIALING

DIALING A STORED NUMBER

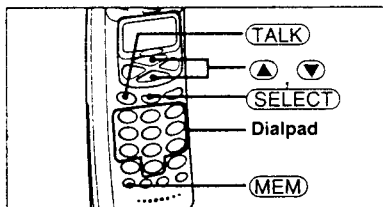

- 1** Pick up the handset and press **MEM**.

1	SMITH JOHN
2	DOE JOHN
3	MOM AND DAD

- 2** Press **▼**, **▲** or enter a number (0-9) to display the desired destination.

NOTE:

To see the stored phone numbers, press **▶**.

If **▶** appears next to the 13th digit, the number is longer than 14 digits. Press **▶** to see the rest of numbers, and **◀** repeatedly to return to the name display.

When you press **SELECT**, the LCD displays both of the name and telephone number.

MOM AND DAD
8175551212

- 3** Press **TALK**. The stored number will be dialed.

NOTE:

If you press **MEM** while you are selecting a location, memory selection is cancelled and the handset is put in standby mode.

MEMORY DIALING

HANGING AND DELETING STORED NUMBERS

You can delete a number or simply store another one in its place. When you store a new phone number, the data stored in that memory location is deleted automatically.

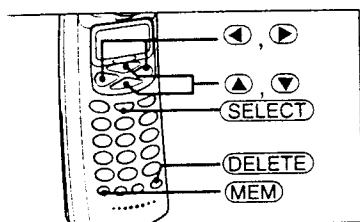

1 Pick up the handset and press and hold **MEM** until a beep sounds.

```
Memory Store
1▶SMITH JOHN
2 DOE JOHN
```

2 Enter a number (0-9) or press **▼**, **▲** to select the memory location you want to edit/delete.

Press **SELECT**. The LCD displays the Edit/Delete Memory screen.

```
▶Edit Memory 1
Delete Memory 1
Go Back
```

3 Press **▼** or **▲** to select the desired function and press **SELECT**. To edit the stored data, select "Edit." To delete the data, select "Delete." To return to the previous screen, select "Go Back."

4 To edit data, go to step **a**. To delete data, go to step **b**.

EDITING THE NAME AND TELEPHONE NUMBER

Use the **▲**, **▼**, **◀**, and **▶** buttons to change the name. (See "Storing Numbers" on page 28 for instructions on how to enter names).

MEMORY DIALING

Press **DELETE** to erase a character at the cursor position.

The next character on the right moves to the cursor position.

- (2) Press **SELECT**. The LCD displays the programmed numbers screen.

```
Store Name
SMITH JOHN
```

- (3) Press **DELETE** to erase numbers, and enter the correct number.

```
Store Number
123456789
```

- (4) Press **SELECT**. A confirmation beep sounds and the number is stored. Press **MEM** or return the handset to the base unit.

```
Memory 1 Stored
```

b DELETING THE STORED DATA

- (1) Press **▲** or **▼** to move the pointer to select Yes or No.

```
Delete Memory 1?
Yes
▶No
```

- (2) Press **SELECT** or **DELETE**.

If **Yes** is selected: A confirmation beep sounds and the number is erased.

```
Memory 1 Deleted
```

If **No** is selected: The LCD returns to the programmed names screen.

```
Memory Store
1▶SMITH JOHN
2 DOE JOHN
```

- (3) Press **MEM**, or return the handset to the base unit.

CALLER ID/CALL WAITING

- Before you can take advantage of the Caller ID and Call Waiting features, you must subscribe to these services from your local telephone company.
- Name and number caller ID only work in conjunction with service provided by your local telephone company.

ANSWERING A CALL WITH CALLER ID SERVICE

- 1 When the caller ID message is received, the display shows the caller's phone number along with the date and time. The incoming call information is stored in Caller ID record. If the Caller ID service includes the caller's name, the caller's name appears on the display (up to 15 letters).

Number of calls from the same phone number	_____
The date and time received	5/11 12:30PM 01
Caller's name	SMITH JOHN
Caller's phone number	123-456-7890

You may receive any one of the following messages;

- When invalid data is receivedIncomplete Data
- When a private name is receivedPrivate Name
- When a private number is receivedPrivate Number
- When an unknown name is receivedUnknown Name
- When an unknown number is receivedUnknown Number

- 2 When you pick up the phone, the display changes to "Talk".

Talk	0:00
<Medium>	

NOTES

- If you answer a call before the Caller ID message is received (Example before the second ring), the Caller ID message will not appear.
- When the call is received via a telephone company that does not offer Caller ID service, the caller's phone number and name do not appear (This includes international calls).
- When the call is via a Private Branch eXchange (PBX), the caller's phone number and name may not appear.
- Data errors appear as " . ".

CALLER ID/CALL WAITING

CALL WAITING

If you want to use the Call Waiting feature, you must subscribe to the Call Waiting service provided by your local telephone company.

The LCD will show another incoming call even if you are currently engaged in a telephone conversation. This feature can be enabled or disabled. If enabled, it informs the user of a new incoming call by generating short beeps at regular intervals until the call is either answered, or the person calling hangs up. With Caller ID on call waiting, you can see who's calling to decide if you want to interrupt your current conversation to answer the incoming call.

WITH CALLER ID SERVICE

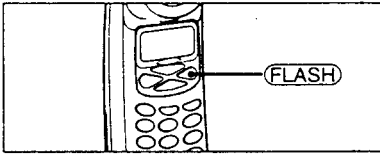

- 1** Before answering a call, check to see that the caller's name and telephone number are displayed on the screen. To switch to the waiting call, press **FLASH** on the handset. The first caller is put on hold.
- 2** To switch back to the first caller, press **FLASH** again.

NOTE:

*Pressing **FLASH** without having received a Call Waiting signal may disconnect the current line.*

CALLER ID/CALL WAITING

SEARCHING CALLER ID MEMORY

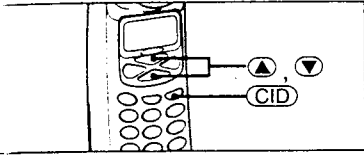

To review who has called your phone, follow the steps below.

The caller ID memory retains a listing of the 50 most recent callers.

1 Pick up the handset and press **CID**.

If new caller ID data does not exist:

Total:02

If there is new caller ID data:

New :01
Total:02

2 Press **▼** to display the latest call record.

1/7 9:30AM 12
DOE JOHN
555-2563

If there is no more caller ID data when you press **▼**, the LCD displays the following message.

End

To display previous records, press **▲**.

3 Press **CID** to return to standby mode.

CALLER ID/CALL WAITING

DIAL OUT

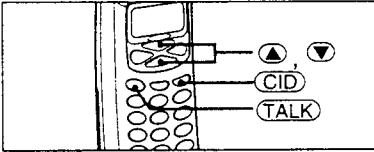

- 1 Pick up the handset and press **(CID)**. Then, press **(▼)** or **(▲)** to display the number you wish to dial.
- 2 Press **(TALK)**.
The displayed number will be dialed.

1/7	9:30AM	12
SMITH JOHN		
456-7890		

TALK
4567890

NOTE:

To enter a number for a long distance call, see "EDITING CALLER ID DATA" page 37. It is not necessary to add a "1" when dialing some area codes. If in doubt, check your local telephone directory.

CALLER ID/CALL WAITING

EDITING CALLER ID DATA

You can edit the Caller ID data.

Pick up the handset and press **(CID)**. Then, press **(▼)** or **(▲)** repeatedly to display the Caller ID data you want to edit.

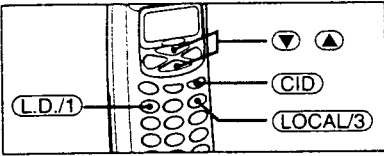

2 Press **(L.D./1)** for a long distance call prefix "1" and **(LOCAL/3)** for area code setting and cancellation.

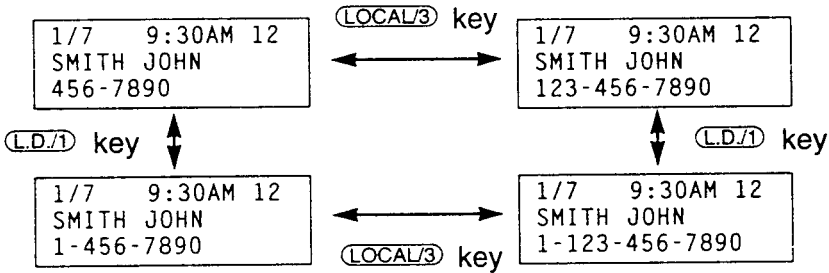

3 After editing Caller ID data, you can continue with dialing out or storing procedures.

To dial out, press **(TALK)** (page 36).

To store into memory dial, press **(MEM)** (page 38).

CALLER ID/CALL WAITING

STORING TO SPEED DIAL MEMORY

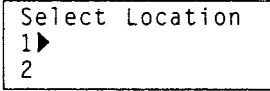
- 1 Pick up the handset and press **(CID)**. Then, press **(v)** or **(^)** to bring up the number you wish to store into Speed Dial memory.
- 2 Press **(MEM)**.
The LCD displays the following screen.

Select Location
1 ▶
2
- 3 Enter a number (0-9) or press **(v)**, **(^)** to select memory location.
- 4 Press **(SELECT)**. A confirmation beep sounds and the Caller ID data is stored. Press **(CID)** to return to standby mode.

If you select a memory location which is already stored:

(1) The LCD displays the following prompt:

(2) Press **(^)** to select Yes and press **(SELECT)**.

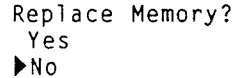

Replace Memory?
Yes
▶No

A confirmation beep sounds and the new data overwrites the old data. The LCD returns to the Caller ID display screen. Press **(CID)** to return to standby mode.

If you select No :

The LCD returns to the Caller ID display screen.

Press **(CID)** to return to standby mode.

CALLER ID/CALL WAITING

DELETING CALLER ID DATA

DELETE INDIVIDUAL CALLER ID DATA:

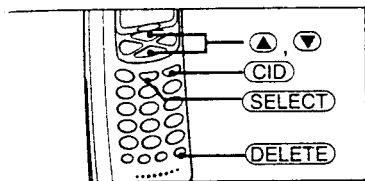

1 Pick up the handset and press **(CID)**. Then, press **(▼)** or **(▲)** to display the caller ID number you wish to delete from the memory.

2 Press **(DELETE)**.

Press **(▲)** or **(▼)** to select Yes or No.

Delete Message?
▶Yes
No

3 Press **(SELECT)** or **(DELETE)**. If you select **Yes**, confirmation beeps are emitted and the LCD displays the next caller ID data. If there is no more caller ID data, the LCD displays the message "End."

If you select **No**, the LCD returns to the Call ID data screen.

4 Press **(CID)** to return to standby mode.

CALLER ID/CALL WAITING

DELETE ALL CALLER ID DATA:

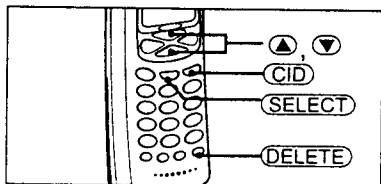

1 Pick up the handset and press **(CID)**. The LCD displays the following screen.

```
New :01
Total:02
```

2 Press **(DELETE)**.
Press **(▲)** or **(▼)** to select Yes or No.

```
Delete All?
Yes
▶No
```

3 Press **(SELECT)** or **(DELETE)**.

If you select **Yes**, a confirmation beep sounds and the LCD displays the total number of items "00".

```
Total:00
```

If you select **No**, the LCD returns to the screen indicating the number of Caller ID calls.

```
New :01
Total:02
```

4 Press **(CID)** to return to the standby mode.

USING THE ANSWERING MACHINE

TURNING THE ANSWERING MACHINE ON & OFF

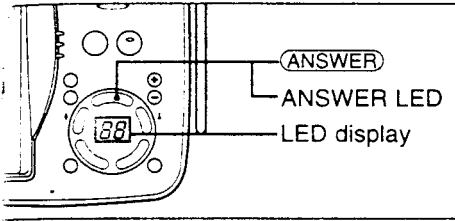

Press **ANSWER** to turn the answering machine on. The LED display and the ANSWER LED will light, and the OGM will be played.

To turn off the answering machine, press **ANSWER**.

NOTE:

If the message storage area is full, the LED display shows "FL" and the system announces "No remaining time" after the OGM. You should delete messages (see page 45). Or, the system cannot record any message.

USING THE ANSWERING MACHINE

RECORDING THE OUTGOING MESSAGE (OGM)

You can record a personalized outgoing message or use the prerecorded message. When a call is received, the answering machine answers the call and plays the OGM.

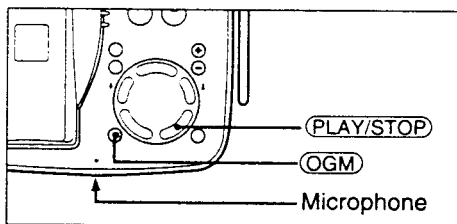

- 1** Press and hold **OGM** on the base unit till a beep sounds.
Record your outgoing message over the microphone. (from 2 seconds up to 30 seconds).
- 2** When you finish, press **OGM** or **PLAY/STOP**.
The OGM just recorded will automatically be played back.

TO CHANGE THE OUTGOING MESSAGE (OGM)

You can change between the pre-recorded OGM and your own recorded OGM.

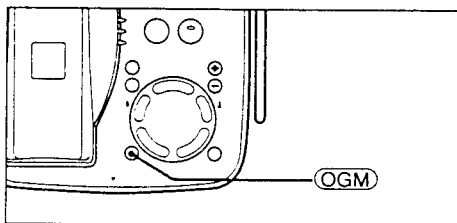

- 1** Press **OGM** on the base unit.
- 2** While the unit is playing the OGM, press **OGM**. The OGM is changed to the other.

USING THE ANSWERING MACHINE

SETTING THE NUMBER OF RINGS

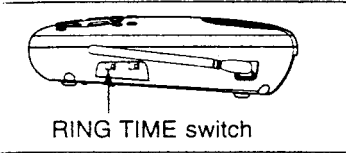

Select one of three ring time settings by sliding the RING TIME switch on the side of the base unit.

- 1: 2 rings
- 2: 4 rings

3 (TOLL SAVER MODE):

The phone answers at the second ring when there are new messages, and the fourth ring when there are no new messages.

When you check the message from the outside phone, hang up if you hear the third ring to save the toll charge.

SETTING THE RECORDING TIME

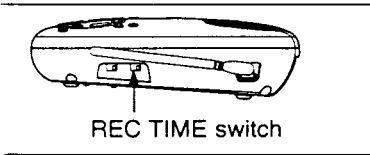

Select one of two maximum recording times or Announce Only by sliding the REC TIME switch on the side of the base unit.

- 1: 1 minute
- 2: 4 minutes

ANN (Announce Only): If you set the switch to ANN, the selected message will be announced and no message will be accepted. The LED display shows "A".

USING THE ANSWERING MACHINE

PLAYING RECORDED MESSAGES

The display shows the total number of recorded messages. If new messages have been recorded, the number blinks.

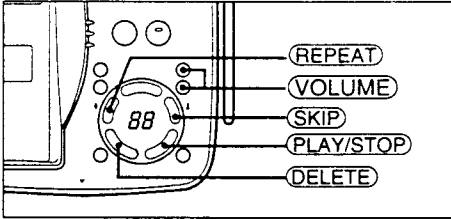

To listen to the messages, press **PLAY/STOP**. Messages will be played in the order they were received. During playback, see the table below for more operation.

To playback the message	Press PLAY/STOP .
To repeat the previous message	Press REPEAT (within 2 seconds after the beginning of message).
To repeat the current message	Press REPEAT (after 2 seconds after the beginning of message).
To skip the message	Press SKIP .
To rewind	Press and hold REPEAT until the message number you want to listen displays.
To go forward	Press and hold SKIP until the message number you want to listen displays.
To delete a message	Press DELETE during playback of the message you want to delete.
To stop playback	Press PLAY/STOP .
To delete all messages	Finish the playback of all messages. Then, press and hold DELETE till a beep sounds.
To adjust the speaker volume (1-10)	Press VOLUME+ or VOLUME- repeatedly.

USING THE ANSWERING MACHINE

DELETING RECORDED MESSAGES

o delete all messages:

Press and hold **(DELETE)** for 2 seconds after playback of all messages.

If there are messages that you have not listened to, you will hear short beeps and the messages will not be deleted.

o delete individual messages:

While playing back the message you want to delete, press **(DELETE)**. The message is deleted and the next message will be played.

SCREENING INCOMING CALLS

You can screen calls when the answering machine is on.

1 After the answering machine answers, the base speaker lets you hear the caller as the machine records the message.

2 To answer the call immediately, follow the instructions below. The answering machine will disconnect automatically.

AT THE HANDSET

With the Auto Talk setting On: Simply pick up the handset, or press **(TALK)** if the handset is away from the base.

With the Auto Talk setting Off: Pick up the handset and press **(TALK)**, or press **(TALK)** if the handset is away from the base.

AT THE BASE UNIT

Press **(SPEAKER)**.

USING THE ANSWERING MACHINE

LEAVING A MEMO MESSAGE

You can use the base unit to record a memo (up to 10 minutes), as a reminder to yourself or as a message for someone else in the household. A memo is stored and played back like any other incoming message, and the LED display will blink to indicate that a message has been received.

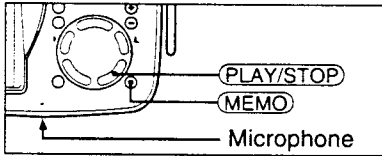

- 1** Press and hold **MEMO** till a beep sounds.
- 2** Begin speaking close to the microphone.
- 3** When you finish recording, press **MEMO** or **PLAY/STOP**.

RECORDING A PHONE CONVERSATION (2WAY REC)

You can record a telephone conversation that is already in progress with the handset (up to 10 minutes). The conversation is stored and played back like an incoming message.

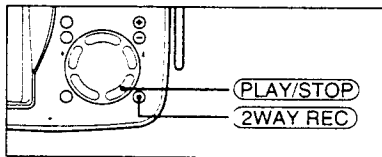

- 1** During a call with the handset, press and hold **2WAY REC** till a beep sounds. Recording starts and both parties hear the intermittent beeps.
- 2** To stop recording, place the handset on the base unit, or press **2WAY REC** or **PLAY/STOP**.

USING THE ANSWERING MACHINE

CALLING IN FROM A REMOTE LOCATION

You can retrieve messages or change answering machine settings by using your phone from a touch-tone phone. Even if the answering machine has been left off, you can still access it by turning it on first.

IF THE ANSWERING MACHINE IS OFF:

Let the phone ring at least 10 times. The line will connect and you will hear several short beeps. Press **#** and enter your PIN.

IF THE ANSWERING MACHINE IS ON:

After playing your outgoing message, press **#** and enter your PIN.

The answering machine announces the day, the time, the number of new and old messages. The unit automatically starts playing the new messages.

Press **#** and the appropriate number button that corresponds to the operation you want (see TABLE OF COMMANDS on next page).

When you finished, press **# 5** and hang up.

NOTES:

When entering your PIN number, the second digit must be entered within 2 seconds after the first one.

If you enter a wrong PIN number 3 times, the line will be disconnected.

Enter the command within 15 seconds while you hear intermittent beeps. Otherwise, the line is disconnected.

*When you call your phone while the message storage area is full, the phone will answer and the OGM will be played after the 10th ring. After playing the OGM, enter **#** and your PIN, then you can continue to enter the commands. During a operation from a remote location, rC appears on the display of the base unit.*

USING THE ANSWERING MACHINE

TABLE OF COMMANDS

OPERATION	Press	Remarks
To repeat an incoming message; (during playback)	# ①	Enter the command within 4 seconds after the beginning of the message to repeat the previous message, and after 4 seconds to repeat the current message.
To playback an incoming message (up to 4 minutes)	# ②	For longer playback, press # ② .
To skip to the next message (during playback)	# ③	
To delete individual messages (during playback)	# ④	
To stop operation	# ⑤	
To turn the answering system on	# ⑥	
To record a memo message (up to 4 minutes) To stop recording	# ⑦ # ⑤ or # ⑦	After you finish recording a memo message, press # ⑤ or # ⑦ .
To record your OGM To stop recording	# ⑧ # ⑤ or # ⑧	After you finish recording your OGM, press # ⑤ or # ⑧ .
To turn the answering system off	# ⑨	
To monitor your room (up to 15 seconds)	# *	

For your handy reference guide, cut out the remote operation cards on page 53.

TROUBLESHOOTING

Should any problem occur with the set, make the following simple tests to determine whether or not servicing is required.

PROBLEM	SOLUTION
<p>No dial tone. No calls come in. You cannot make a call.</p>	<ul style="list-style-type: none"> • The AC adaptor of the base unit is disconnected. → Plug the AC adaptor into the base unit and the AC 120V outlet. • The battery is low. → Place the handset on the base unit to recharge. • Telephone line cord is disconnected. → Check both ends of the telephone jack. • The previous call was not disconnected. → Press TALK to disconnect the line. • Trouble with the telephone line. → Check an extension line. • Outlet used is controlled by a wall switch in its OFF position. → Relocate to another outlet. • The digital security code is changed. → Disconnect the power and remove the handset. After a few seconds, restore the power and place the handset on the base unit for at least 3 seconds. • The handset is too far from the base unit. → Bring the handset near the base unit. • You press the button while the handset is on the base unit's charging cradle. → Pick up the handset from the base unit before you press TALK.
<p>Noise or interference.</p>	<ul style="list-style-type: none"> • The handset is too far from the base unit. → Bring the handset near the base unit. • The battery is low. → Place the handset on the base unit to recharge. • The base unit is located in a place with high interference. → Relocate to another outlet. • Interference from TV, appliances, etc. → Press CH to select a clearer channel, or relocate the base unit. • There may be line noise. → Check with another telephone. • The volume control is set too high. → Reduce volume to lower setting. • The base antenna is not in a vertical position. → Lift the antenna to a vertical position.
<p>Battery goes low quickly.</p>	<ul style="list-style-type: none"> • The battery was not fully charged at the initial charging. → Charge the battery for 12 to 16 hours without any interruption. • The battery is several years old. → Replace with a new battery.

TROUBLESHOOTING

PROBLEM	SOLUTION
The handset battery does not charge.	<ul style="list-style-type: none"> • The battery is not installed correctly. → Install the battery correctly.
	<ul style="list-style-type: none"> • The charging contacts of the handset and base are not clean. → Clean them with a dry cloth.
	<ul style="list-style-type: none"> • The battery is several years old. → Replace with a new battery.
The unit operates abnormally.	<ul style="list-style-type: none"> • The phone needs to be reset. → Disconnect the AC adaptor and reconnect it after a few seconds.
"Low Battery" blinks on the LCD. The operation is stopped.	<ul style="list-style-type: none"> • The battery is low. → Recharge the battery.
When the handset is returned to the base unit with the volume level set at Loud, a momentary squeal or howling sound may sometimes be heard.	<ul style="list-style-type: none"> • This is normal. → It may be prevented by changing the volume setting to High, Medium or Low before returning the handset to the base unit.
The phone does not display the Caller ID/Caller ID on Call Waiting data.	<ul style="list-style-type: none"> • You have to subscribe Caller ID/Caller ID on Call Waiting services. → Check with your local telephone company.
	<ul style="list-style-type: none"> • You answer the call before Caller ID data is received. → Let the phone ring twice before you answer the call.
	<ul style="list-style-type: none"> • CIDCW option is set to off. → Set the CIDCW option On to display CIDCW (see page 16).
The messages are not recorded/incomplete.	<ul style="list-style-type: none"> • The message was too long or too short. → The message should not be longer than the recording time (1 or 4 minutes), or shorter than 2 seconds.
	<ul style="list-style-type: none"> • The recording capacity became full. → Delete recorded messages.
	<ul style="list-style-type: none"> • The phone was answered during recording.
	<ul style="list-style-type: none"> • The recording time is set to ANN (announce only). → Set the REC TIME to 1 or 4 minute setting.
The answering machine does not respond to remote operation.	<ul style="list-style-type: none"> • You are not calling from a touch tone phone. → Call from a touch tone phone.
	<ul style="list-style-type: none"> • The PIN you entered was wrong. → Make sure you entered the correct PIN.
The answering machine does not answer the call.	<ul style="list-style-type: none"> • The recording capacity is full. → In this case, the phone will answer and the OGM will be played after 10 rings. After playing the OGM, enter Ⓢ and your PIN.
The LED display shows "A".	<ul style="list-style-type: none"> • This is normal. The recording time is set to ANN (announce only). → Set the REC TIME to 1 or 4 minute setting.

WARRANTY/SERVICE

SERVICE REQUIREMENTS

If the cordless telephone should malfunction, or need changes or modifications, all repairs will be performed by an authorized Toshiba Service Station. This unit has been registered with the FCC for direct connection to the telephone network. Under the FCC program, no customer is authorized to repair this unit. This applies to units either in or out of warranty. If an unauthorized repair is performed, the registration of the unit for direct connection to the network will be null and void. If the unit is still in warranty, the remainder of the warranty period will also be null and void.

It is the responsibility of users requiring service to report the need for service to the Toshiba dealer.

IMPORTANT INSTRUCTIONS TO USERS

Your telephone equipment has been designed and constructed to conform to federal regulations and can be connected to the phone line as described in this manual.

Please note that each product connected to the telephone line places a certain load on the line. We designate this as the unit's "Ringer Equivalence Number."

It is most unlikely, but...If your telephone equipment should cause problems on the phone line, the phone company has the right to temporarily discontinue your service. If this happens, the phone company will notify you and give you the opportunity to correct the problem. Also, you need to know that the phone company does have the right to make changes in their lines and/or equipment.

If these changes might affect your telephone equipment (or require changes in the telephone equipment or its connection), the phone company will notify you in writing, so you have the chance to take whatever action necessary to ensure uninterrupted phone service.

FCC REQUIREMENTS

You are no longer required by the FCC to notify your local telephone company of your intent to connect a new telephone. Your local telephone company may call you and request information about your phone such as: the brand name, model number, registration number, and ringer equivalence number. This information is provided on a label located at the bottom of the base unit and handset.

You may not directly connect your telephone equipment to coin telephone services. Check with your local telephone company if you wish to connect your telephone equipment to a party line service. Some party line services require a special adaptor or modification to your telephone.

It should be noted that some cordless telephones operate at frequencies that may cause interference to nearby TVs and VCRs; to minimize or prevent such interference, the base of the cordless telephone should not be placed near or on top of a TV or VCR; and, if interference is experienced, moving the cordless telephone farther away from the TV or VCR will often reduce or eliminate the interference.

WARRANTY/SERVICE

TELEPHONE/TELEPHONE ANSWER MACHINE LIMITED WARRANTY

Toshiba America Consumer Products, Inc. ("TACP") and Toshiba Hawaii, Inc. ("THI") make the following limited warranties. These limited warranties extend to the original consumer purchaser or any person receiving this set as a gift from the original consumer purchaser and to no other purchaser or transferee.

Limited One(1) Year Warranty of Labor and parts

TACP/THI warrant this product and its parts against defects in materials or workmanship for a period of one(1) year after the date of original retail purchase. During this period, TACP/THI will repair or replace your defective product with a new or refurbished unit at our option.

Owner's Manual

You should read the owner's manual thoroughly before operating this product.

Your Responsibility

The above warranties are subject to the following conditions.

- (1) You must provide a copy of your bill of sale or other proof of purchase.
- (2) These warranties are effective only if the product is purchased and operated within the USA or Puerto Rico.

(3) Within the continental U.S.A., if you should find a defective product within the warranty period please call 1-877-644-7373.

(4) Warranties extend only to defects in materials or workmanship as limited above and do not extend to any product or parts which have been lost or discarded by you, or to damage to products or parts caused by misuse, accident, damage caused by Acts of God, such as lightning or fluctuations in electric power, improper installation, improper maintenance or use in violation of instructions furnished by us; or to units which have been altered or modified without authorization of TACP/THI, or to damage to products or parts thereof which have had the serial number removed, altered, defaced or rendered illegible.

(5) Physically damaged products are not acceptable for repair or exchange within or after the warranty period expires.

How to Obtain Warranty Service

In the event a problem should develop with your product, please proceed as follows:

In The Continental United States contact:

www.toshiba.com/tacp

In Hawaii contact:

Toshiba Hawaii, Inc.
327 Kamakee Street,
Honolulu, HI 96814
(808)-591-8377

All warranties implied by state law, including the implied warranties of merchantability and fitness for a particular purpose, are expressly limited to the duration of the limited warranties set forth above. With the exception of any warranties implied by state law as hereby limited, the foregoing warranty is exclusive and in lieu of all other warranties, guarantees, agreements and similar obligations of manufacturer or seller with respect to the repair or replacement of any parts. In no event shall TACP/THI be liable for consequential or incidental damages.

No person, agent, distributor, dealer or company is authorized to change, modify or extend the terms of these warranties in any manner whatsoever. The time within which an action must be commenced to enforce any obligation of TACP/THI arising under the warranty or under any statute, or law of the United States or any state thereof, is hereby limited to ninety(90) days from the date you discover, or should have discovered, the defect. This limitation does not apply to implied warranties arising under state law.

This warranty gives you specific legal rights and you may also have other rights which may vary from state to state. Some states do not allow limitation on how long an implied warranty lasts, when an action may be brought, or the exclusion or limitation of incidental or consequential damages, so the above provisions may not apply to you.

REMOTE OPERATION CARDS

CUT

CUT

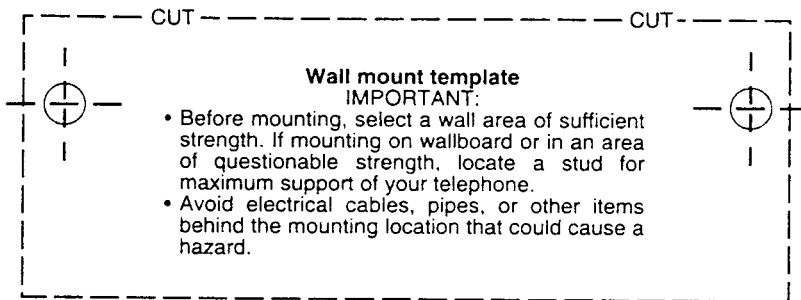

Wall mount template
IMPORTANT:

- Before mounting, select a wall area of sufficient strength. If mounting on wallboard or in an area of questionable strength, locate a stud for maximum support of your telephone.
- Avoid electrical cables, pipes, or other items behind the mounting location that could cause a hazard.

CUT

TOSHIBA

REMOTE OPERATION GUIDE

A Call your machine from touch tone phone. After your machine answers, enter # and PIN (Access Code) pressing each digit for at least 1 second. If you enter # and PIN correctly, your machine sounds invitation tone after the announcement of the time and others. Now enter the command (# and number) by pressing the keypad.

B To playback incoming and memo messages, press #2. To skip, press #3

during playback. To repeat, press #1 during playback. To delete, press #4 during playback.

C To record memo message, press #7. To record OGM, press #8. To stop recording, press #5. To turn on the answer mode, press #6. To turn off the answer mode, press #9. To monitor your room, press #* .

D To stop operation, press #5.

CORTE

TOSHIBA

GUÍA DE OPERACIONES POR CONTROL REMOTO

A Llame a su teléfono desde un teléfono de teclado. Después que su teléfono conteste, introduzca # y el código de acceso (PIN) presionando cada dígito durante 1 segundo como mínimo. Si introduce correctamente # y el PIN, su teléfono emitirá un tono de invitación después del anuncio de la hora y demás. Luego introduzca el mandato (# y un número) presionando las teclas.

B Para reproducir los mensajes recibidos y los memorandos presione #2. Para saltar presione #3 durante la reproducción. Para repetir presione

#1 durante la reproducción. Para borrar presione #4 durante la reproducción.

C Para grabar mensajes de memorando presione #7. Para grabar un mensaje de contestación presione #8. Para detener la grabación presione #5. Para activar o desactivar el modo de contestación presione #6. Para desactivar el modo de contestación presione #9. Para escuchar el sonido de su sala, presione #* .

D Para detener la operación presione #5.

REMOTE OPERATION CARDS

CUT

WHILE PLAYING THE OGM, KEY-IN (#) AND PIN

MESSAGE REPEAT (#) (1)	MESSAGE PLAYBACK (#) (2)	MESSAGE SKIP (#) (3) (during playback)
MESSAGE DELETE (#) (4) (during playback)	RECORD STOP/ OPERATION STOP (#) (5)	ANSWER ON (#) (6)
MEMO RECORD (#) (7)	OGM RECORD (#) (8)	ANSWER OFF (#) (9)
ROOM MONITOR (#) (X)	(0)	REMOTE ACCESS (#) PIN

CORTE

DURANTE LA REPRODUCCIÓN DEL MENSAJE DE CONTESTACIÓN, PRESIONE (#) Y PIN

REPETICIÓN DE MENSAJE (#) (1)	REPRODUCCIÓN DE MENSAJE (#) (2)	SALTO DE MENSAJE (#) (3) (durante la reproducción)
BORRADO DE MENSAJE (#) (4) (durante la reproducción)	DETENCIÓN DE GRABACIÓN/OPERACIÓN (#) (5)	ACTIVACIÓN DE CONTESTACIÓN (#) (6)
GRABACIÓN DE MENSAJE DE MEMORANDO (#) (7)	GRABACIÓN DE MENSAJE DE CONTESTACIÓN (#) (8)	DESACTIVACIÓN DE CONTESTACIÓN (#) (9)
MONITOR DE SALA (#) (X)	(0)	ACCESO AL CONTROL REMOTO (#) PIN

Additional Information

For technical assistance, purchase of accessories or service, please access www.toshiba.com/tacp.

IMPORTANT

We suggest you record the following information and retain for your records along with your bill of sale or equipment document.

Model no. _____ **Serial no.** _____

Purchase date _____ **Dealer** _____

Dealer address _____

© 2000 TOSHIBA AMERICA CONSUMER PRODUCTS, INC.