

TOSHIBA

OWNER'S MANUAL

10 CH AUTO SCAN CORDLESS TELEPHONE

FT-6310

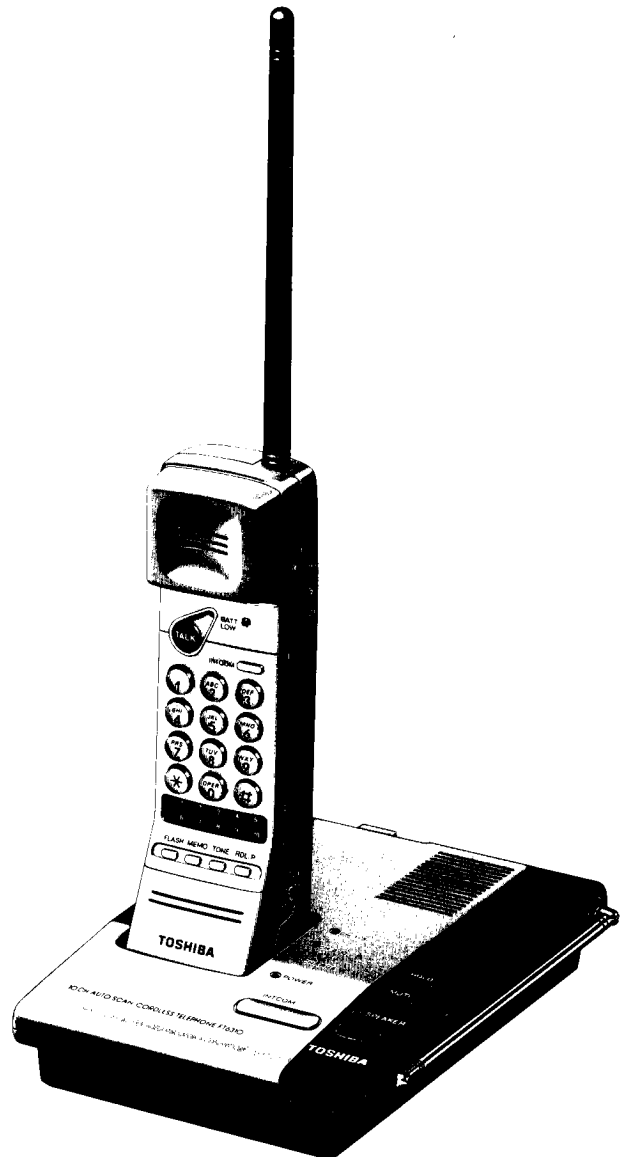

Should your unit require service, please refer to the
"Toshiba service procedure" in your owner's manual.

① INTRODUCTION

Toshiba America takes pride in presenting the FT-6310, one of the finest telephones available. Intelligent design, superb craftsmanship, and the latest technological advances have been combined to provide you with a telephone that is easy to operate and will provide you with years of dependable service. Please take the time now to read your Owner's Manual carefully, so that you may enjoy the many convenient features of your FT-6310 telephone.

FEATURES

- Telephone numbers can be dialed using tone, rotary dial pulse service, or a combination of both.
- Automatic and manual dialing can be combined within the same dialing sequence.
- Up to 10 telephone numbers can be stored in memory, each with a maximum length of 16 digits.
- Pauses may be programmed, where needed, in the middle of an automatic dialing sequence.
- Memory locations can be accessed individually or successively, in any order or combination, all in one dialing sequence.
- Combination storage is available for simplified memory programming and expanded number range.
- Compatibility with alternate long distance services.
- Automatic Redial button for access to last dialed telephone number (up to 22 digits).
- Designed for use as a wall phone or desk phone.
- Flash function for convenient hook-switch control.
- 2-Way Intercom allows communication between the handset and the base unit.
- Hearing Aid Compatibility lets you use your cordless telephone if you wear a hearing aid equipped with a T (telephone) switch.
- Remote channel scan (10 channel) automatically searches the best channel to avoid interference.
- Touch Dial Light button allows more convenient dialing when the unit is used in the dark.
- Speakerphone on the base unit allows handsfree conversations for any incoming call or with intercom operation.
- Programmable Digital Security Codes (256) prevent unauthorized calls.
- Mute function turns off the microphone.
- Battery low indicator.
- Volume control for the speakerphone and intercom.
- Adjustable Ringer volume (HI/LOW/OFF).
- Compander noise reduction circuit minimizes any noise from radio or other appliances as much as possible.

IMPORTANT

Before using your new phone please follow these instructions

The Digital Security Code, which enables the handset and the base unit to communicate with each other, will not activate unless the handset's battery pack is charged in the base unit with the handset's Power ON/OFF switch in the ON position.

The correct sequence needed to activate the digital security code is as follows:

- ① Connect the AC adaptor plug to the DC jack on the rear of your base unit and plug AC plug into your home electricity outlet.
- ② Install the battery pack in the handset and switch the Power ON/OFF to the ON position (located on the lower right side of the handset).
- ③ Leave the handset in the base unit overnight **12 hours to 16 hours to ensure a full charge.**

When replacing the battery pack, please follow the same procedure.

WARNING

TO REDUCE THE RISK OF ELECTRIC SHOCK, DO NOT REMOVE COVER (OR BACK). THERE ARE NO USER SERVICEABLE PARTS INSIDE. PLEASE REFER SERVICING TO QUALIFIED SERVICE PERSONNEL.

DO NOT PRESS ANY OF THE BUTTONS WHILE YOU ARE SPEAKING.



DO NOT PULL OUT THE PLUG WHILE YOU ARE SPEAKING.

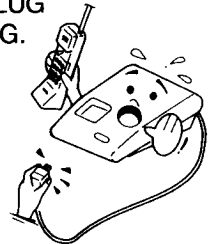

CLEAN WITH A DRY CLOTH.

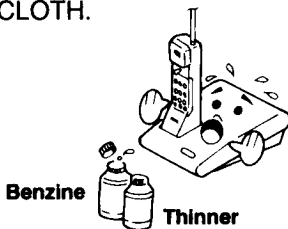

DO NOT USE.

DO NOT EXPOSE TO HEAT.

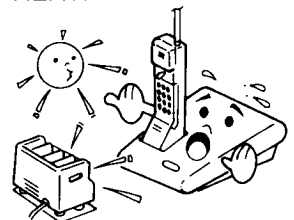

Clean the battery charging contacts in handset and base unit regularly with a dry cloth so that sufficient contact is made.

PRECAUTIONS

- **Before initial use, charge the battery pack in the battery compartment of the handset for approximately 12 to 16 hours.**
(For details, refer to page 10 "CHARGING THE HANDSET'S BATTERY PACK")
- Operate the AC adaptor on 120V AC, 60 Hz.
- Use only the AC adaptor supplied for this unit. Do not use any other AC adaptor.
- Unplug the AC adaptor from the wall outlet when the cordless telephone system is not to be used for an extended period of time. To disconnect the AC adaptor, pull it out by grasping the body. Never pull it by the cord.
- Do not install the base unit in a location near a heat source such as radiators or airducts, or in a place subject to direct sunlight, excessive dust, moisture, rain, mechanical vibration, or shock.
- Do not place the units on or near a TV set or a personal computer, as these units may interfere with each other.
- Should any liquid or solid object fall into the base unit, unplug the unit and have it checked by qualified service personnel before operating the unit any further.
- Keep spring-wound watches and personal credit cards using a magnetic coding away from the unit to prevent their being damaged by the strong magnet installed between the charge contacts on the base unit.
- This unit is designed and approved for single lines only. It should not be connected to multiple lines or a coin telephone or party lines.
- There is no guarantee that interference will not occur in a particular installation. If this equipment does cause interference to radio or television reception, which can be determined by turning the equipment off and on, the user is encouraged to try to correct the interference by one or more of the following measures:
 - reorient the receiving antenna
 - relocate the equipment with respect to the receiver
 - move the equipment away from the receiver
 - plug the equipment into a different outlet so that equipment and receiver are on different branch circuits.

If necessary, the user should consult the dealer or an experienced radio/television technician for additional suggestions. The user may find the following booklet prepared by the federal communications commission helpful:

"How to identify and resolve Radio-TV interference problems".

This booklet is available from the U.S. Government Printing Office,
Washington, DC 20402,
Stock No. 004-000-00345-4.

If you have any question or problem concerning your set that is not covered in this manual, please consult the nearest Toshiba Service Station authorized to service telephone terminal equipment.
For Customer Service, Call **1-800-631-3811**

HANDSET CONTROLS AND FUNCTIONS

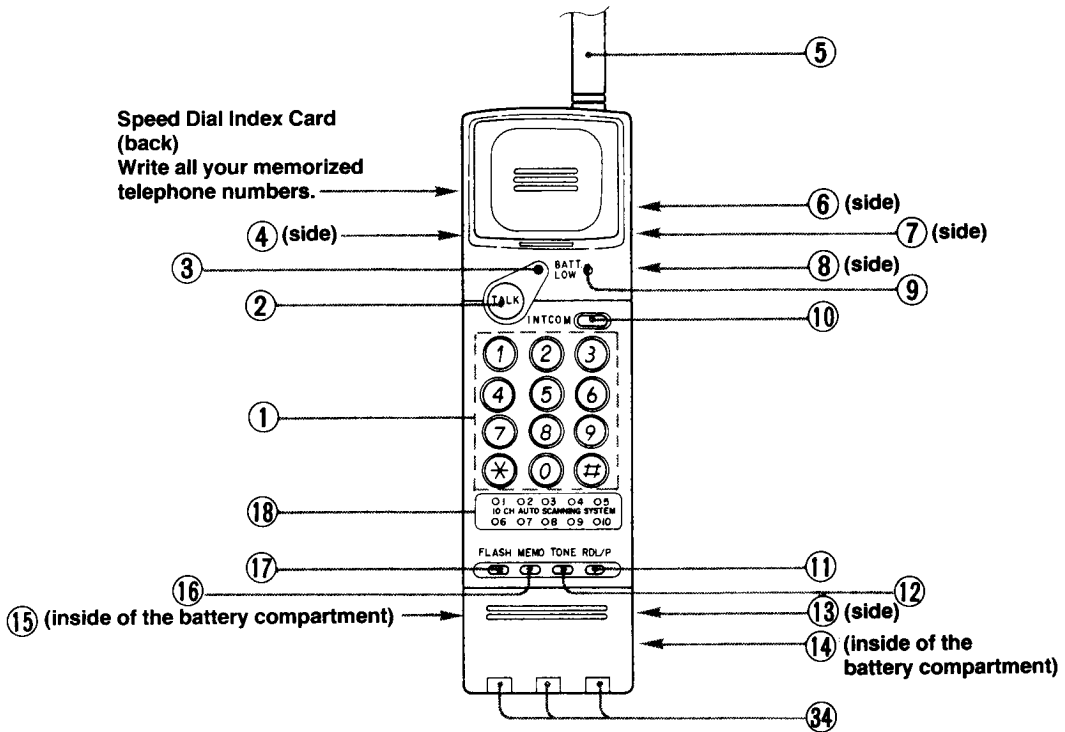

- ① **0-9, * , # Buttons** — Used for dialing numbers, storing numbers to memory and setting the digital security code.
- ② **Talk Button** — Places the handset into talk mode or back to standby when used away from charging the base unit.
- ③ **Talk LED** — Lights when the handset is in the talk mode.
- ④ **Touch Light Button** — Lights all the dialpad buttons when pressing and holding.
- ⑤ **Helical Antenna** — Durable high-gain helical antenna.
- ⑥ **Volume High/Low Button** — Allows you to adjust the volume of an incoming call, high or low.
- ⑦ **Channel Scan Button** — Selects the best channel when interference noise is heard.
- ⑧ **Mute Button** — Deactivates outgoing speech for private in-room conversations.
- ⑨ **Battery Low LED** — Lights when the handset battery is low and needs to be recharged.
- ⑩ **Intercom Button** — Press to communicate with a person at the base unit.
- ⑪ **Redial/Pause Button** — Redials the last number dialed, or inserts a pause into memory dialing sequences.
- ⑫ **Tone Button** — When the Tone/Pulse switch inside of the battery compartment of the handset is in **pulse**; one touch of this button allows tone dialing for access to long distance services, etc. This also functions when storing numbers to memory. (The pulse to tone override works on each individual call).
- ⑬ **Power ON/OFF Switch** — Turns power on and off to the handset to maximize battery life when not in use.
- ⑭ **Rechargeable Battery Pack** — User replaceable and rechargeable for long, trouble-free service.
- ⑮ **Tone/Pulse Switch** — Selects either DTMF tone dialing or pulse dialing (inside of the battery compartment).
- ⑯ **Memory Button** — Used when storing numbers to memory and setting the digital security code.
- ⑰ **Flash Button** — Sends a timed hookflash on the telephone line for accessing telephone company services such as call waiting, etc.
- ⑱ **Channel Scan LED's** — Lights when the best channel is selected and goes off after 10 seconds.

BASE UNIT CONTROLS AND FUNCTIONS

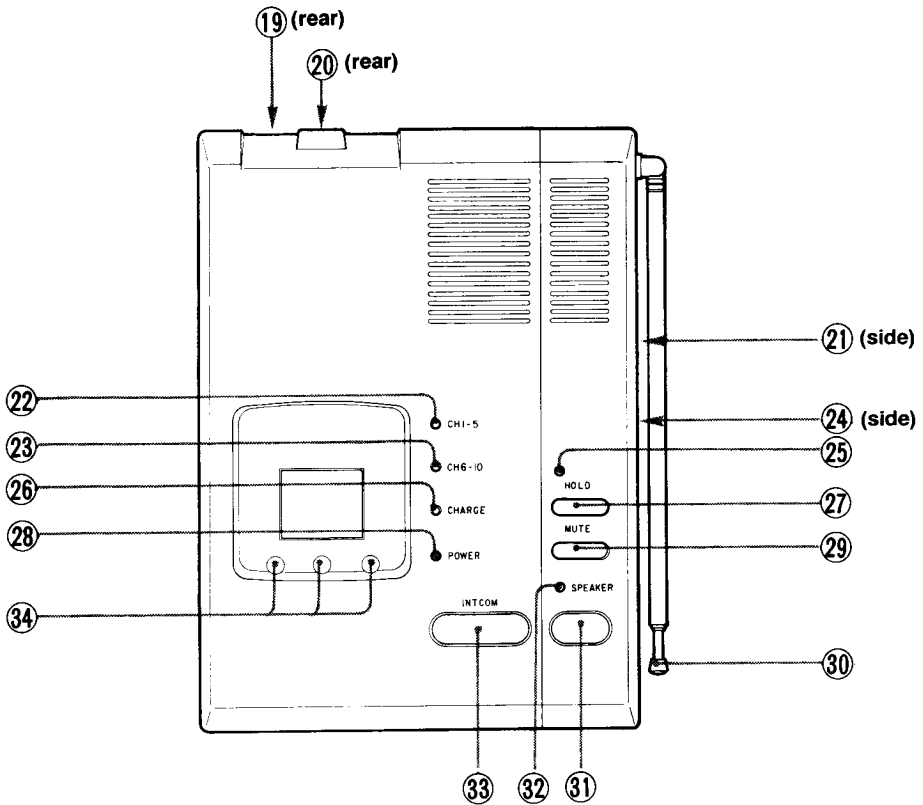

- ①9 **DC Jack** — Plugs one end of the AC adaptor into a standard wall outlet and the other end into the rear of the base unit to provide power for the base unit and charging for the handset.
- ②0 **Telephone Modular Jack** — Plugs one end of the telephone line cord into a standard RJ11C telephone line jack and the other end into this jack for connecting the base unit to the telephone line.
- ②1 **Ringer Volume High/Low/OFF Switch** — Selects a loud or soft ring or no ring at all at the speakerphone mode.
- ②2 **and** ②3 **Channel Selector LED's** — Light when the Channel Scan button on the handset is pressed and searched the best channel.
- ②4 **Volume Control** — Allows you to adjust the volume of your speakerphone and at the intercom mode.
- ②5 **Hold LED** — Lights when the Hold button is pressed.
- ②6 **Charge LED** — Lights when the handset is fully seated on the charge contacts of the base unit.
- ②7 **Hold Button** — Lets you place an incoming call on hold when you are talking with the base speakerphone.
- ②8 **Power LED** — Lights when power is supplied to the unit from the AC outlet.
- ②9 **Mute Button** — Deactivates outgoing speech for private in-room conversations.
- ③0 **Base Antenna** — Collapsible antenna provides maximum range when fully extended.
- ③1 **Speakerphone Button** — Allows you to talk with an incoming caller.
- ③2 **Speakerphone LED** — Lights at the speakerphone mode and blinks in the mute mode.
- ③3 **Intercom Button** — Press to communicate with a person at the handset.
- ③4 **Charging Contacts** — Provides power to charge the handset when it is placed on the base unit.

② INSTALLATION

CONNECTING THE TELEPHONE LINE

There are three basic types of phone wall outlets you may find in your home:

(1) Modular USOC: RJ11C jack, (2) 4-prong jack, or (3) hard-wired type

(1) If you have a modular wall jack,

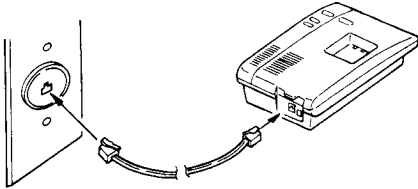

- ① Plug one end of the telephone line cord into the base modular jack on the rear of the base unit.
- ② Plug the other end of the telephone line cord into the modular wall jack.

(2) If the existing receptacle is a 4-prong jack,

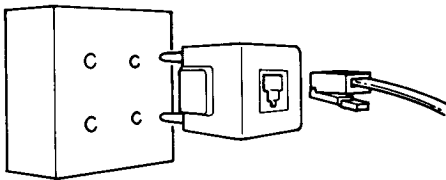

An adaptor (not included) is required. The adaptor plugs into the 4-prong jack and the phone's modular plug connects to the adaptor.

(3) If your phone cord is hard-wired into an outlet and you have no jack,

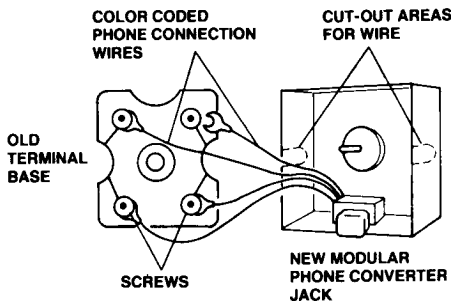

A modular jack converter (not included) is required, entailing some rewiring (namely, making color-coded connections).

Note

The dealer from whom you purchased your telephone or a telephone supply store can advise you regarding the proper adaptor or converter.

Notes

- Never install telephone wiring during a lightning storm.
- Never install telephone jacks in wet locations unless the jack is specifically designed for wet locations.
- Never touch uninsulated telephone wires or terminals unless the telephone line has been disconnected at the network interface.
- Use caution when installing or modifying telephone lines.

WALL-MOUNTING THE BASE

You can mount your cordless telephone's base unit on a wall using the supplied wall mount adaptor.

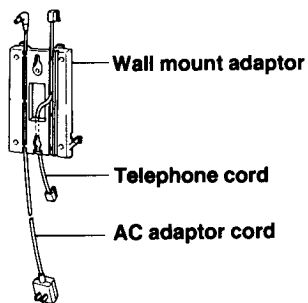

- ① Attach the AC adaptor cord and the telephone cord to the wall mount adaptor.

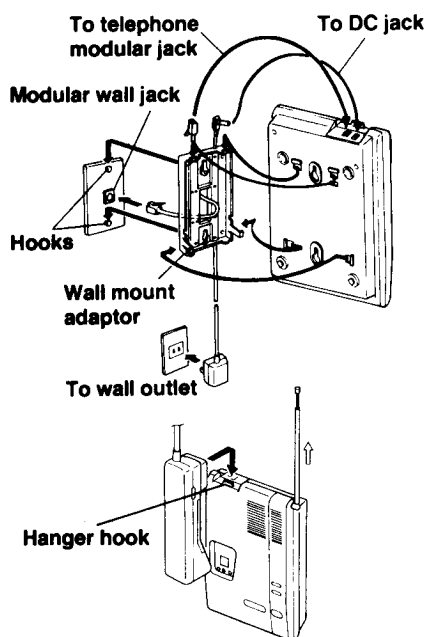

- ② Align the installation hooks with the slots on the wall mount adaptor. Insert telephone in the adaptor and push down. Then, hook the wall mount adaptor with the base unit to the modular wall jack.

- ③ Hook the handset at the hanger hook on the base unit. Extend the base antenna to its full length.

Note

In step ②, if you cannot hook the wall mount adaptor, attach it directly to the wall using two supplied screws together with the template (see page 10) as a guide for placement on the mount screws.

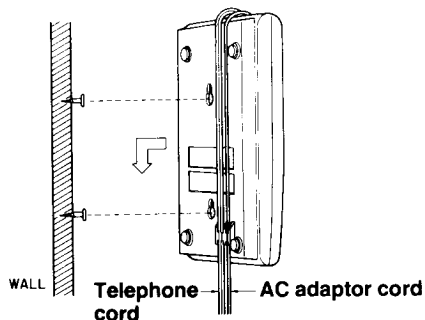
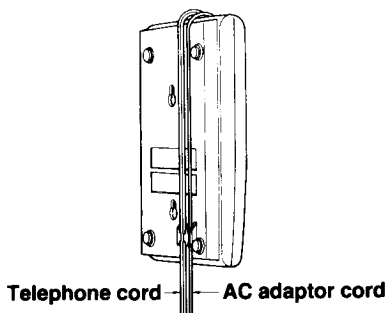
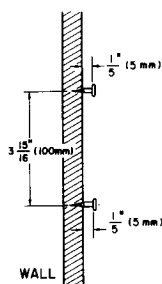

- ① Thread the screws into the wall, letting the heads extend about $\frac{1}{5}$ inch.
- ② Route the phone cord and adaptor cord through the guides on the back of the base unit.
- ③ Place the base's keyhole slots over the two screws and gently push down on the base unit to lock it into place.

INSTALLING THE BATTERY PACK

Installing the battery pack in your FT-6310 is quick and easy.

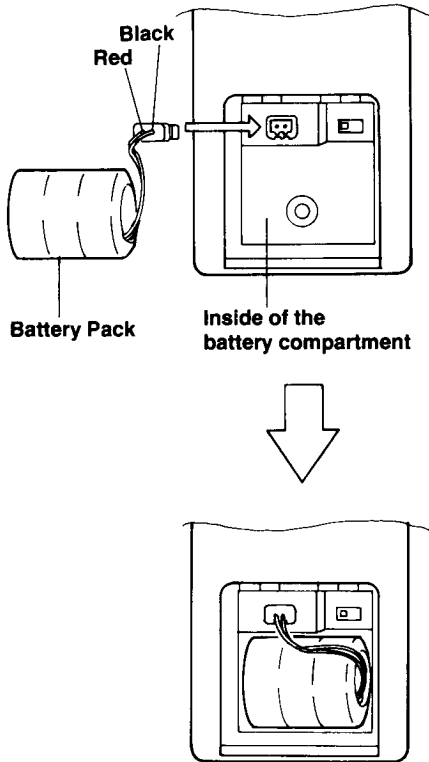

First, remove the battery compartment cover on the back of the handset by sliding it down.

- ① Plug the battery pack's connector into the connector in the battery compartment.

Note

Do not force the connectors together. They fit only one way.

- ② Place the battery pack in the battery compartment.
- ③ Replace the battery compartment cover by sliding it on.

Make sure not to get the wires from the battery pack caught in the cover.

Note

Make sure to set the Power ON/OFF switch at OFF position when you replace the battery pack with a new one.

Should the need arise to purchase Parts or Accessories, please call **1-800-631-3811** for the location of the nearest parts distributor. (See page 23).

CONNECTING THE AC POWER

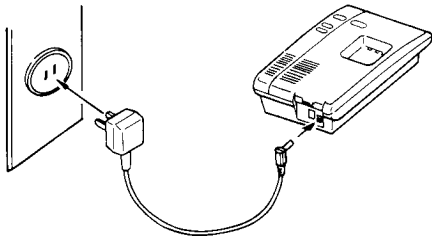

Connect the plug at the end of the AC adaptor to a standard 120V AC outlet and the other end to the rear of the base unit.

Make sure to route the AC adaptor cord where it will not create a trip hazard, or where it could become chafed and create fire or other electrical hazards.

Note

Do not attach the AC power supply cord to building surfaces using metal fittings.

CHARGING THE HANDSET'S BATTERY PACK

The handset's battery pack is supplied fully discharged. Before you use the handset for the first time, charge its battery pack for approximately 12 to 16 hours.

- ① Before you charge the battery pack the first time, set the handset's Power ON/OFF switch to the ON position.
- ② Place the handset on the base unit. The Charge LED lights as the battery pack charges. If the LED does not light, be sure that the AC adaptor is plugged in.

Notes

- The handset's battery pack does not charge properly if the charging contacts are dirty or tarnished. Clean the contacts occasionally with a dry cloth.
- The supplied rechargeable battery pack should last for several years, however, it eventually loses its ability to fully charge and you will need to replace it with a new one. You can order a replacement rechargeable battery pack at your local Toshiba dealer or authorized parts distributor. Call **1-800-631-3811**.

SETTING THE POWER ON/OFF SWITCH

- ① Before you can use your FT-6310, you must first turn ON the power to the handset.
- ② Make sure to set this switch at the ON position when used. In the OFF position, you are unable to operate the unit even by pressing the Talk button. The Power ON/OFF switch is located on the lower right side of the handset. Select the ON position to switch on the power to the handset.
- ③ The base unit has no power switch. As long as it is plugged into a wall outlet, it is switched on and ready to use for making calls, activating the intercom or charging the battery in the handset.

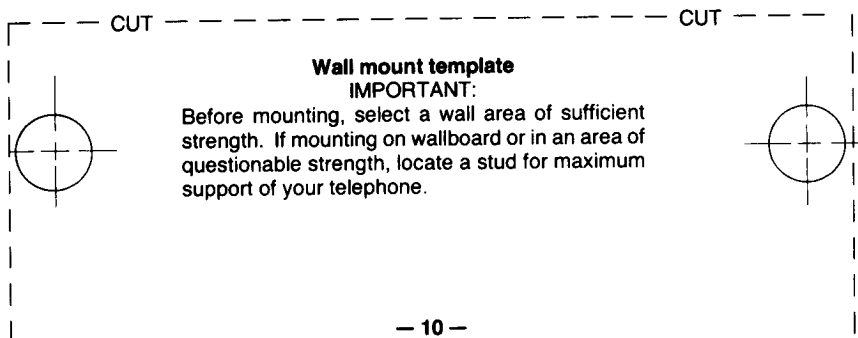
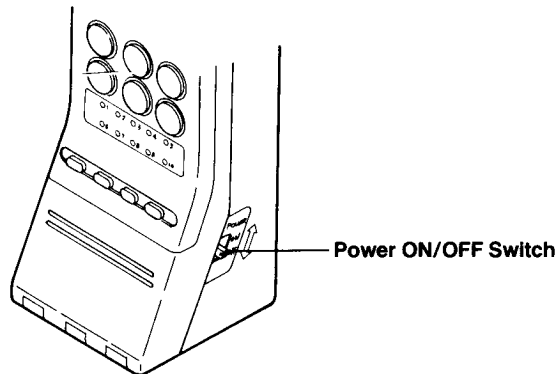

③ THE BASICS

With the FT-6310 telephone numbers can be dialed using tone, rotary pulse, or a combination of both services.

Pulse dialing is compatible with most local telephone company dialing systems. When your phone is in the Pulse mode, you will hear a tone for each number pressed, and then pulsing sounds such as those generated by a rotary dial phone.

Tone dialing provides the tone signals required for independent, low cost long distance and other special tone-dialing services. Tone dialing will work only in those areas where the local phone company offers Tone Service. Subscribing to that service generally requires an extra monthly charge.

TONE-PULSE SELECTION

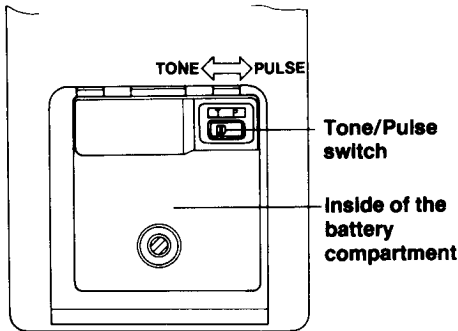

Set the handset's Tone/Pulse switch located inside of the battery compartment for the type of service you have (tone or pulse). If you are not sure which type of service you have, do this simple test.

- ① Set Tone/Pulse switch to Tone position.
- ② Lift the handset and press the Talk button to listen for a dial tone.
- ③ Press any number other than 0. If the dial tone stops, you have Tone service. If the dial tone continues, you have Pulse service.
- ④ If you have Pulse service, set Tone/Pulse switch to Pulse position.

PLACING A CALL

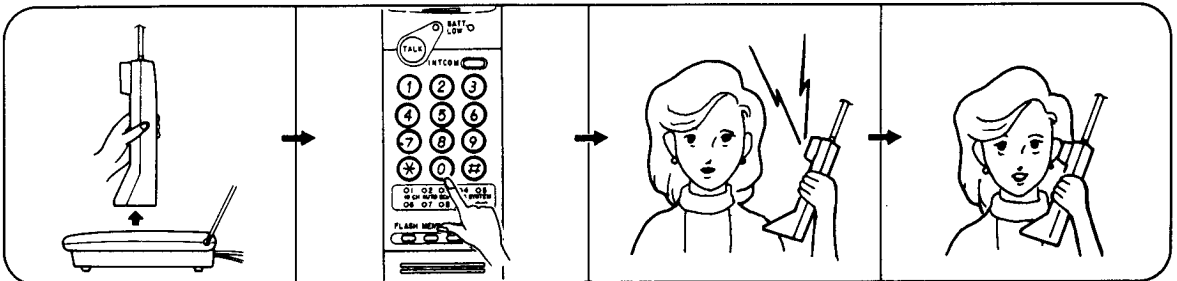

Lift the handset from the base unit, and press the Talk button. The Talk LED lights.

Dial the desired phone number by pressing the numbered buttons.

Wait for the phone you have called to begin ringing.

When the other party answers, you may begin speaking. To end the call, return the handset to the base unit or press the Talk button.

Note

The telephone call is cut off if power fails during a conversation, so immediately return the handset to the base unit.

ANSWERING A CALL

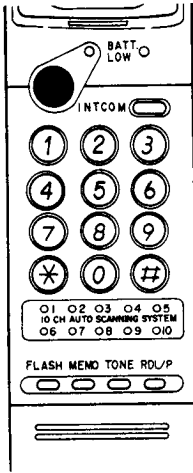

From the handset

Simply lift the handset from the base unit to answer the call; there is no need to press the Talk button. However, if the handset is already out of the base unit when the phone begins to ring, you will still have to press the Talk button to answer your call.

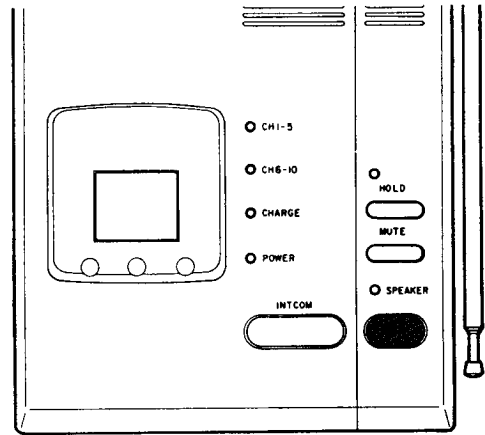

From the base unit

Press the Speakerphone button and speak. To exit the call, press the Speakerphone button again. The Speakerphone LED goes off and the call is dropped.

USING THE REDIAL BUTTON

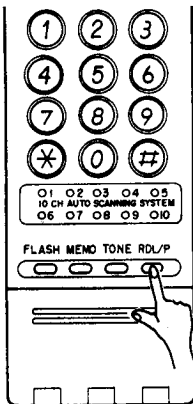

The Redial button dials the last number (up to 22 digits) that you called. This feature is extremely useful when the number you called is busy.

To use this feature, simply press the RDL/P button **immediately** after selecting the talk mode. The last number called will then be dialed again.

Note

If any key is pressed before the RDL/P button, it will not redial. The RDL/P button must be pressed **immediately** after selecting the talk mode.

USING THE FLASH BUTTON

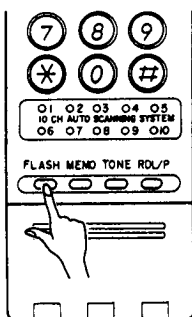

The Flash button is used to send a timed hookflash on the telephone line for accessing services such as call waiting, etc. (Call Waiting is a telephone company service).

To use this feature, simply press the Flash button while in the talk mode.

Flash may also be used to obtain a new dial tone. Be careful not to press "Flash" during normal conversation as this will cause your party to be cut off.

USING THE TONE BUTTON

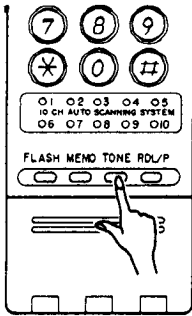

If you have rotary (Pulse) telephone service, the Tone button allows you to access a computer or computer-based services such as Sprint, MCI, etc., that respond to Tone signals only.

- ① Dial the local number to the computer or calling service with the Tone/Pulse switch in the Pulse position.
- ② After you have reached the number, press the Tone button and continue to dial your access code or any other numbers required.

USING THE INSTANT TALK FUNCTION

When your FT-6310 is ringing with an incoming call, simply removing the handset from the base unit will answer the call; there's no need to press the Talk button.

Note

If the handset is already out of the base unit when the phone begins to ring, you will still have to press the Talk button to answer your call.

USING THE INSTANT STANDBY FUNCTION

When you have finished with a call, placing the handset back on the base unit automatically switches the handset to go into Standby mode, and hangs up the phone. There's no need to press the Talk button to hang up.

Note

If you don't place the handset back on the base unit, you will need to press the Talk button again to hang up the phone.

SETTING THE DIGITAL SECURITY CODE

The Digital Security Code is randomly set at the factory.

Pick up the handset from the base unit if you wish to change the setting.

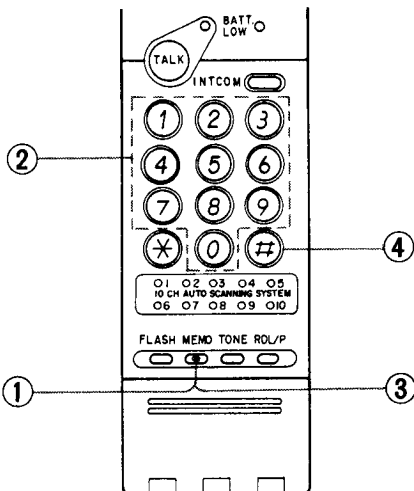

- ① Press the Memory button.
- ② Press any 3 digit number between 000 - 255.
- ③ Press the Memory button again.
- ④ Press the # key. You will hear a long beep tone.

Immediately place the handset in the base unit to complete the code change. This procedure will change the code in the base unit and the handset. The code can be changed as often as desired.

Note

An error tone gives warning if you press any number other than 000 — 255 (such as 999).

BATTERY LOW LED

When the battery pack in the handset is very low and needs to be recharged, the Battery Low LED will light. When this occurs, complete the call that you are making as rapidly as possible, and return the handset to the base unit for charging.

USING THE TOUCH LIGHT BUTTON

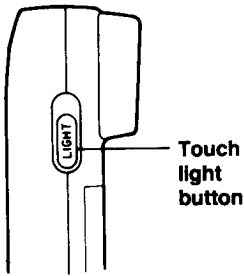

Allows you to see all the dialpad buttons backlit in the dark when pressing and holding this Light button.

USING THE VOLUME/CHANNEL SCAN/MUTE BUTTONS

Volume Button

You can adjust the volume of incoming call through the handset. High or low volume can be controlled by pressing the Volume button alternately.

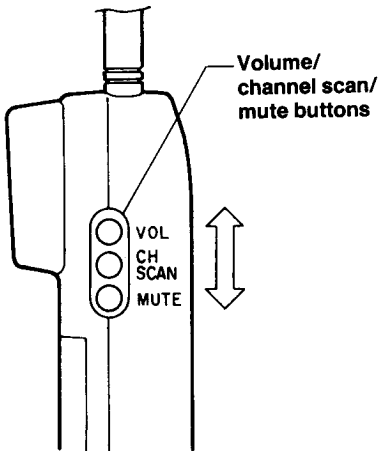

Channel Scan Button

Your FT-6310 automatically scans and selects the best channel by pressing the Channel Scan button when interference noise is heard. One of the Channel scan LED's keeps lighting for ten seconds and goes off. Each Channel LED 1 — 5 or 6 — 10 on the base unit will also light to indicate which channel being used.

Mute Button

Press and hold this Mute button to turn off the microphone during a telephone conversation so that you may speak to someone in the room with you without the caller overhearing. If the Mute button is released, the microphone is turned on to continue normal conversation.

USING THE INTERCOM/SPEAKERPHONE/HOLD BUTTONS

Intercom Function

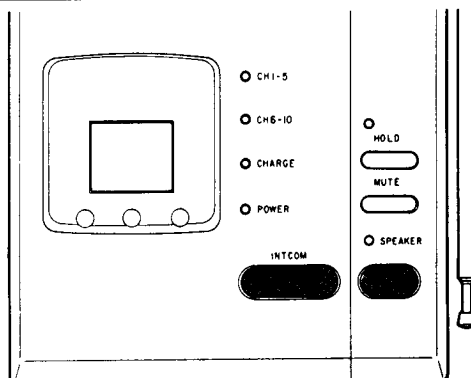
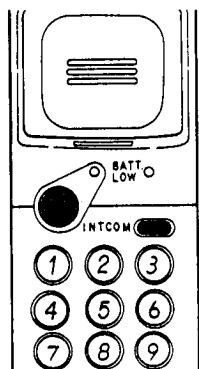

Intercom from handset to base unit

- ① Press the Intercom button on the handset. A beep tone comes out from the handset and the base unit.
- ② Press the Talk button on the handset within ten seconds to communicate between the base unit and the handset. The Talk LED and the Speakerphone LED on the base unit light up. Speak normally.
- ③ To end the communication, press either the Talk button on the handset or the Speakerphone button on the base unit.

Intercom from base unit to handset

- ① Press the Intercom button on the base unit. A beep tone comes out from the base unit and the handset.
- ② Press the Talk button on the handset within ten seconds to communicate between the handset and the base unit. The Talk LED lights. The base unit automatically enters the speakerphone mode, lighting the Speakerphone LED. Speak normally.
- ③ To end the communication, press the either the Speakerphone button on the base unit or the Talk button on the handset.

Notes

- Don't press the Talk button before you press the Intercom as in step ① above. (If you press the Talk, you will connect an outside line and then put that line on hold by pressing the Intercom.) Press the Intercom button before the Talk button to start properly.
- If the Power ON/OFF switch is in the OFF position by mistake during the communication, this mode stops and some noise may generate out of the base unit. This is not an electrical problem and you may resume normal operation after 10 seconds in the ON position.
- If the Power ON/OFF switch on the handset is in the OFF position, the handset will not beep. The handset must be in the ON position to receive a page for intercom operation. The paging beeps a tone for about 10 seconds but if you press this button again during this period, the unit turns to stand-by mode.
- For the base unit to receive intercom page, set the Ringer Volume switch in HI for a louder ring and LO or OFF position for a softer ring.

Incoming Hold Function

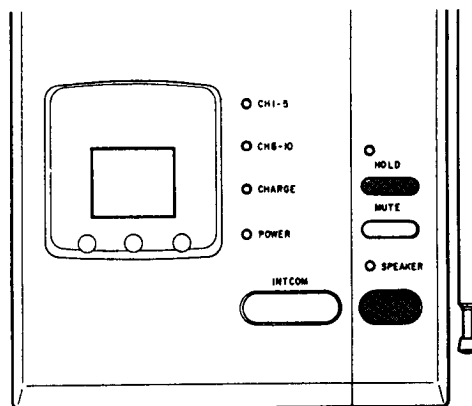
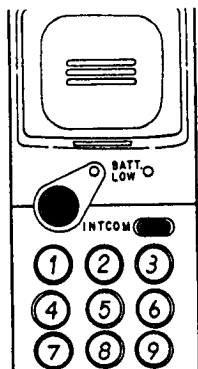

Incoming hold at the handset

- ① Press the Talk button on the handset to receive an incoming call. The Talk LED will light.
- ② Press the Intercom button on the handset during a call.
- ③ The call will be put on hold and the Hold LED will light.
- ④ To resume the conversation, press the Intercom button on the handset again.

Incoming hold at the base unit

- ① Press the Speakerphone button on the base unit to receive an incoming call. The Speakerphone LED will light.
- ② Press the Hold button. The call will be put on hold. The Hold LED will light and the Speakerphone LED will go off.
- ③ To resume the conversation, press the Speakerphone button again.

Incoming Call Transfer

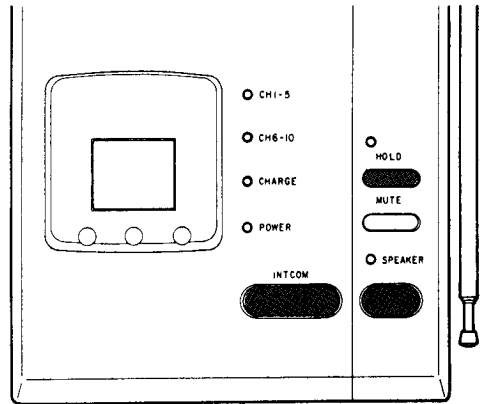
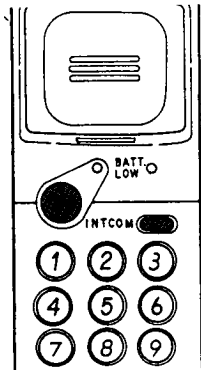

Transfer of incoming call at the handset to the base unit

- ① Press the Talk button on the handset to receive an incoming call. The Talk LED will light.
- ② Press the Intercom button on the handset to call the base unit. This puts the incoming call on hold and the Hold LED on the base unit will light.
- ③ Press the Intercom button on the base unit to receive the intercom from the handset. The Speakerphone LED will light.

Note:

The conversation between the handset and the base unit is possible at this mode but if the Intercom button on the handset is pressed again due to no answer or nobody at the base unit, the handset can still communicate with the incoming call. Press the Talk button to end the conversation.

- ④ Press the Talk button on the handset to transfer the incoming call to the base unit. The Talk LED and the Hold LED will go off and the transfer is completed.
- ⑤ Press the Speakerphone button to end the conversation when you have finished speaking.

Transfer of incoming call at the base unit to the handset

- ① Press the Speakerphone button on the base unit to receive an incoming call. The Speakerphone LED will light.
- ② Press the Hold button. The Hold LED will light and the Speakerphone LED will go off. This puts the incoming call on hold.
- ③ Press the Intercom button on the base unit to call the handset.
- ④ Press the Talk button on the handset to receive the intercom from the base unit.

Note:

The conversation between the base unit and the handset is possible at this mode but if the Speakerphone button on the base unit is pressed again due to no answer or nobody at the handset, the base unit can still communicate with the incoming call. Press the Speakerphone button to end the conversation.

- ⑤ Press the Speakerphone button on the base unit to transfer the incoming call to the handset. The Speakerphone LED and the Hold LED will go off and the transfer is completed.
- ⑥ Press the Talk button again to end the conversation when you have finished speaking.

Incoming Ring during Intercom Mode

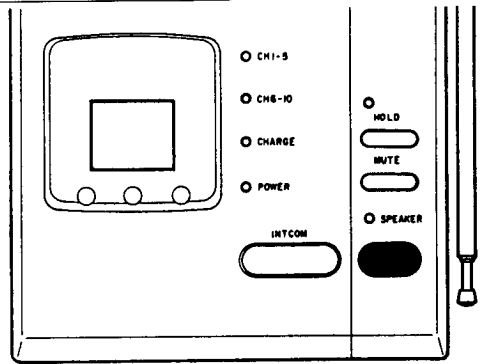
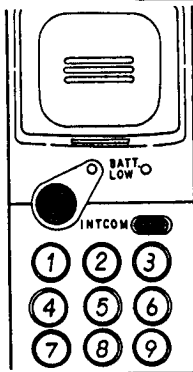

To receive an incoming call at the handset

- ① Press the Intercom button once.
- ② To end the conversation, press the Talk button.

To receive an incoming call at the base unit

- ① Press the Speakerphone button twice.
- ② To end the conversation, press the Speakerphone button again.

Room Monitor Function

You can monitor any sounds near or around the base unit if the Intercom button and the Talk button on the handset are pressed (regardless of which position is selected for the Ringer Volume High/Low/OFF switch on the base unit.) This is a convenient way to monitor the base unit if the handset and the base unit are located in a different area.

Procedure

- ① Press the Intercom button first.
- ② Press the Talk button.
- ③ Monitor any sounds near or around the base unit.
- ④ To end the monitor, press the Talk button.

Note

If the Ringer Volume High/Low/OFF switch is set at the OFF position, a soft tone sounds from the base unit.

USING THE RINGER VOLUME HIGH/LOW/OFF SWITCH

You can select and adjust the ringer volume. For a louder ring, set the Ringer volume switch (located on the base unit) on HI. For a softer ring, set it on LO. For no ring at all, slide the switch to the OFF position. Note that the handset will ring regardless of which position you have selected.

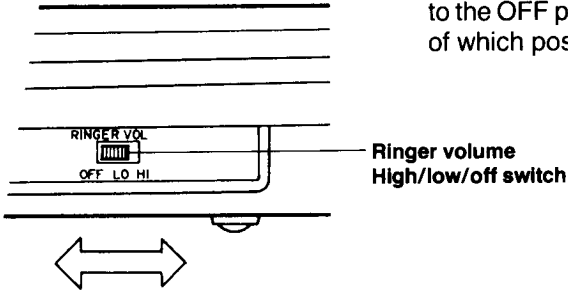

USING THE VOLUME CONTROL

You can adjust the incoming volume from the speakerphone and the intercom through the handset. For a louder sound, slide this control to the right side.

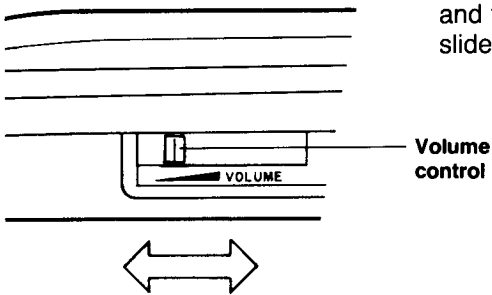

USING THE HOLD BUTTON

Once the speakerphone on the base unit has been activated, you may place a call on hold by pressing the Hold button on the base unit. The Hold LED will light and the Speakerphone LED will be turned off. To resume your conversation, simply press the Speakerphone button again.

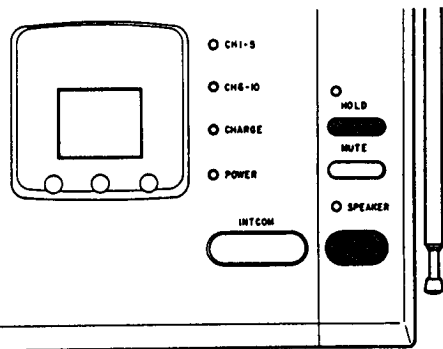

USING THE MUTE BUTTON

Pressing the Mute button turns off the microphone during a telephone conversation at the speakerphone and the intercom so that you may speak to someone in the room with you without the caller overhearing. The Speakerphone LED will blink in this mute mode. Press the Mute button again to resume normal conversation.

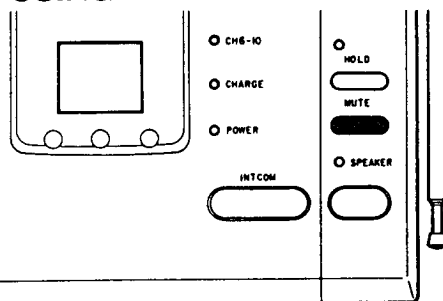

④ MEMORY DIALING

You can store up to 10 of your most frequently-called telephone numbers in memory by using the Memory button.

Note

Phone numbers of up to 16 digits (including a digit for a pause or a tone) can be stored.

STORING NUMBERS

- ① Pick up the handset from the base unit. (**Do not press the Talk button.**)
- ② Press the Memory button.
- ③ Dial the desired telephone number.
- ④ Press the Memory button.
- ⑤ Select and press one of the numbers 0 to 9 for whichever number memory you wish to use.

EXAMPLE: MEMO → ⑨ ① ② ④ ③ ⑤ → MEMO → ③

Notes

- Be sure to listen for the tone or pulsing sound as you press each number. This will ensure that the number pressed has been properly entered into storage.
- If you want to use the Talk button or the Intercom button after pressing the Memory button, wait for ten seconds and change the mode.

When the number you have entered has been successfully stored, a long beep will be heard. If you wish to enter a pause between numbers (as for accessing a switchboard, or long distance service), press the RDL/P button at the point in the number sequence you wish to pause. Pressing the RDL/P button more than once will increase the length of the pause between numbers.

If you have more telephone numbers to store in memory, repeat the steps from ② to ⑤.

After having stored all of the telephone numbers you want,

- ⑥ Return the handset to the base unit.
- ⑦ Record the telephone numbers on the Speed Dial Index Card which is located at the back of the handset.

Note

If you press the wrong number during the storage procedure, you can press FLASH once to clear the memory. Then to reprogram, start from step ②.

STORING MIXED TONE/PULSE NUMBERS

Your FT-6310 can also store mixed mode numbers to make it easy to access long distance services. To store a mixed mode number.

- ① First make sure the Tone/Pulse switch inside of the battery compartment is in pulse mode.
- ② Press the Memory button (a short beep will be heard), and enter the numbers to be dialed in the pulse mode.
- ③ Press the Tone button on the handset and enter the numbers to be dialed in the tone mode.
- ④ When done entering numbers, press the Memory button, and the number of the memory where you want to save the number in.

You will then hear a long beep when the number has been successfully stored. If you wish to enter a pause between any of the numbers in the dialing sequence (such as for switchboard delay etc.), press the RDL/P button at the point you wish to pause in the number sequence. Pressing the RDL/P button more than once will increase the amount of the delay. (Each pause adds a 4 second delay.)

EXAMPLE:

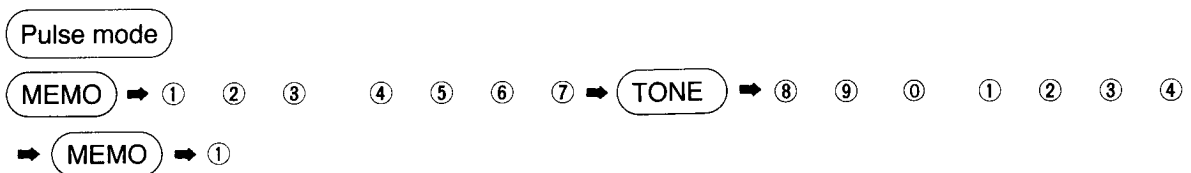

ERASING A STORED NUMBER

- ① Pick up the handset. (Do not press the Talk button.)
- ② Press the Memory button twice.
- ③ Press the desired memory location 0 to 9.

EXAMPLE : MEMO → MEMO → ⑤

The telephone number stored in ⑤ will be erased.

REPLACING A TELEPHONE NUMBER

Just store the new number following the same steps as in STORING. The new number will take the place of the old one.

DIALING A STORED NUMBER

To dial a number previously stored in memory,

- ① Pick up the handset and press the Talk button.
- ② Press the Memory button.
- ③ Press the memory number 0 to 9.

Your FT-6310 will then dial the previously stored number.

USING PAUSE FUNCTION

This RDL/P button is very useful when making an outgoing call through a PBX and using long-distance services. Each time the RDL/P button is pressed, a pause of about four seconds will be inserted during the dialing sequence. If more than four seconds are needed, press the button twice.

To store the number "0-1234567" in memory for a call through a PBX, follow these steps.

Example:

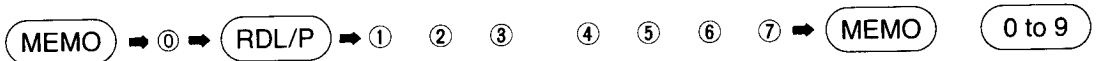

Pressing the RDL/P button or resetting the dial mode once is counted as one digit of the number.

USING CHAIN DIALING

This function is useful in dialing numbers longer than 16 digits. For example a long distance number and a credit card number could be in 2 memory locations.

- Press Talk button, Memory button and memory location (0 to 9)

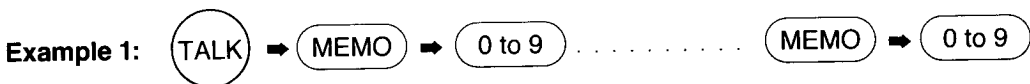

Mixing memory dial and manual dialing are possible.

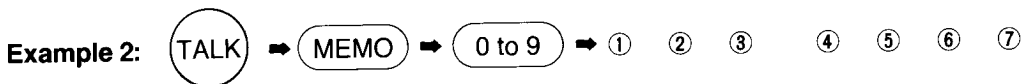

If necessary for further operating instruction, call 1-800-221-0314.

SPECIFICATIONS

HANDSET

Power Source	Customer Replaceable Ni-Cd Battery 280mAH 3.6V DC
Battery Life	7 Hours Normal Operation 7 Days Standby Mode
Dimensions (H/W/D)	Approx. 7-7/8" x 2-5/32" x 2-5/32" (200 x 55 x 55mm) Antenna Length 6-5/8" (170mm)
Weight	Approx. 11 oz (310g)

BASE UNIT

Power Source	AC 120V
Dimensions (H/W/D)	Approx. 1-7/8" x 5-23/32" x 8-11/32" (48 x 145 x 212mm)
Weight	Approx. 1.25 lbs (580g)

SUPPLIED ACCESSORIES

Rechargeable Battery (TRB-6000)	(1)
AC Adaptor (TAC-6200)	(1)
Telephone Cord (6 ft long)	(1)
Telephone Cord (10 inch long)	(1)
Owner's Manual	(1)
Wall Mount Adaptor (WMA-6000)	(1)
Wall Mount Screw	(2)

For purchase of Rechargeable Battery and Wall Mount Adaptor, please call **1-800-631-3811**.

TROUBLESHOOTING GUIDE

Should any problem occur with the set, make the following simple tests to determine whether or not servicing is required. If the problem persists after you have made these tests, call **1-800-631-3811** for Customer Service.

Problem	Cause
No dial tone	<ol style="list-style-type: none">1. AC adaptor of the base unit not plugged into 120 volt AC outlet.2. Battery is low in power — place the handset in the base unit and recharge.3. Telephone line cord detached — check wall jack.4. Talk button in standby — switch to talk position.5. Telephone line trouble — check line with a conventional phone.6. Power switch off — check and turn on.
No calls coming in	<ol style="list-style-type: none">1. All of the above except 4.2. Talk button is in the talk position — switch to standby position.
Static noise on conversation	<ol style="list-style-type: none">1. Approaching maximum range of the base unit — make sure that the base antenna is fully extended.2. Outside range of the base unit.3. Battery is low — place the handset in the base unit and charge.4. Base located in an area with high interference — relocate the base unit.5. General interference from TV, appliances, etc. — move away from interference source.

SERVICE REQUIREMENTS

If the cordless telephone should malfunction, all repairs will be performed by an authorized Toshiba Service Station. This unit has been registered within the FCC for direct connection to the telephone network. Under the FCC program, no customer is authorized to repair this unit. This applies to a unit both in and out of warranty. If an unauthorized repair is performed, the registration of the unit for direct connection to the network will be null and void. If the unit is still in warranty, the remainder of the warranty period will also be null and void.

IMPORTANT INSTRUCTIONS TO USERS

Your FT-6310 has been designed and constructed to conform to federal regulations and can be connected to the phone line as described in this manual.

Please note that each product connected to the telephone line places a certain load on the line. We designate this as the unit's "Ringer Equivalence Number".

It is most unlikely, but . . . If your FT-6310 should cause problems on the phone line, the phone company has the right to temporarily discontinue your service. If this happens, the phone company will notify you and give you the opportunity to correct the problem. Also, you need to know that the phone company does have the right to make changes in their lines and/or equipment.

If these changes might affect your FT-6310 (or require changes in the FT-6310 or its connection), the phone company will notify you in writing, so you have the chance to take whatever action necessary to ensure uninterrupted phone service.

FCC REQUIREMENTS

You are no longer required by the FCC to notify your local telephone company of your intent to connect a new telephone. Your local telephone company may call you and request information about your phone such as: the brand name, model number, registration number, and ringer equivalence number. This information is provided on a label located at the bottom of the base unit and handset.

You may not directly connect your FT-6310 to coin telephone services. Check with your local telephone company if you wish to connect your FT-6310 to a party line service. Some party line services require a special adaptor or modification to your telephone.

TELEPHONE/TELEPHONE ANSWER MACHINE LIMITED WARRANTY

Toshiba America Consumer Products, Inc. ("TACP") and Toshiba Hawaii Inc. ("THI") make the following limited warranties. These limited warranties extend to the original consumer purchaser or any person receiving this set as a gift from the original consumer purchaser and to no other purchaser or transferee.

Limited One (1) Year Warranty

TACP and THI warrant this product and its parts against defects in materials or workmanship for a period of one year after the date of original retail purchase. During this period, TACP and THI will repair a defective product or part, without charge to you. You must deliver the entire set to an Authorized TACP/THI Factory Service Center. You pay for all transportation and insurance charges for the set to and from the Factory Service Center.

Limited One (1) Year Warranty of Parts

TACP and THI warrant the parts in this product against defects in materials or workmanship for a period of one year after the date of original retail purchase. During this period TACP and THI will replace a defective part without charge to you. You must also deliver the entire product to one of the Factory Service Centers listed below. You pay for all transportation and insurance charges for the product to and from the Factory Service Center.

Owner's Manual

You should read the owner's manual thoroughly before operating this product.

Step-By-Step Procedures — How To Obtain Warranty Service

IN THE CONTINENTAL UNITED STATES . . .

Should your unit require service or parts, CALL Toll Free 1-800-631-3811



HAWAII

Toshiba Hawaii Inc.
Service Department
327 Kamakee Street
Honolulu, HI 96814
Phone Number:
(808) 521-5377

IN THE EVENT A PROBLEM SHOULD DEVELOP WITH YOUR PRODUCT, PLEASE PROCEED AS FOLLOWS:

- (1) Contact a TACP/THI Factory Service Center for warranty service within thirty (30) days after you find a defective product or part. You can find an Authorized TACP/THI Service Station by calling this toll free number 1-800-631-3811 or by contacting one of the TACP/THI Service Centers listed below.
- (2) Arrange for the delivery of the product to the Authorized TACP/THI Service Station. Products shipped to the Service Station must be insured and safely and securely packed, preferably in the original shipping carton, and a letter of explaining the defect and also a copy of the bill of sale or other proof of purchase must be enclosed. All transportation and insurance charges must be prepaid by you.
- (3) If you have any question about service, please contact one of the following TACP/THI Service Centers:

EAST
82 Totowa Road
Wayne, NJ 07470
Phone Number:
(201) 628-8000

SOUTHEAST
490 Armour Circle, N.E.
Atlanta, GA 30324
Phone Number:
(404) 872-6955

MIDWEST
1010 Johnson Drive
Buffalo Grove, IL 60089
Phone Number:
(708) 541-9400

SOUTHWEST
1421 Champion Drive
Suite 304
Carrollton, TX 75006
Phone Number:
(214) 243-1367

WEST
19500 South Vermont Ave.
Torrance, CA 90502
Phone Number:
(213) 770-3300

IMPORTANT: PACKING AND SHIPPING INSTRUCTIONS

When you send the product to a service center, you should use the original carton box and packing material, then insert the original carton box containing the unit into another carton, using more packing material.

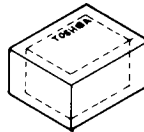

ALL WARRANTIES IMPLIED BY STATE LAW, INCLUDING THE IMPLIED WARRANTIES OF MERCHANTABILITY AND FITNESS FOR A PARTICULAR PURPOSE, ARE EXPRESSLY LIMITED TO THE DURATION OF THE LIMITED WARRANTIES SET FORTH ABOVE. Some states do not allow limitations on how long an implied warranty lasts, so the above limitation may not apply to you. **WITH THE EXCEPTION OF ANY WARRANTIES IMPLIED BY STATE LAW AS HEREBY LIMITED, THE FOREGOING EXPRESS WARRANTY IS EXCLUSIVE AND IN LIEU OF ALL OTHER WARRANTIES, GUARANTEES, AGREEMENTS AND SIMILAR OBLIGATIONS OF MANUFACTURER OR SELLER WITH RESPECT TO THE REPAIR OR REPLACEMENT OF ANY PRODUCT OR PARTS.**

IN NO EVENT SHALL TACP OR THI BE LIABLE FOR CONSEQUENTIAL OR INCIDENTAL DAMAGES. Some states do not allow the exclusion or limitation of incidental or consequential damages so the above limitation may not apply to you.

No person, agent, distributor, dealer, service station or company is authorized to change, modify or extend the terms of these warranties in any manner whatsoever. The time within which an action must be commenced to enforce any obligation of TACP and THI arising under this warranty or under any statute, or law of the United States or any state thereof, is hereby limited to one year from the date you discover or should have discovered, the defect. This limitation does not apply to implied warranties arising under state law. Some states do not permit limitation of the time within which you may bring an action beyond the limits provided by state law so the above provision may not apply to you.

This warranty gives you specific legal rights and you may also have other rights which vary from state to state.

IMPORTANT

We suggest you record the following information and retain for your records along with your bill of sale or equivalent document.

Model no. _____ **Serial no.** _____
Purchase date _____ **Dealer** _____
Dealer address _____

© **1990 TOSHIBA AMERICA CONSUMER PRODUCTS, INC.**