

TOSHIBA

OWNER'S MANUAL

2.4GHz DIGITAL SPREAD SPECTRUM CORDLESS TELEPHONE

SG-1700



The **FIRST** thing to do after unpacking your new cordless telephone is:

CHARGE THE BATTERY !

Please read and follow the few instructions on

PAGE 6

BEFORE YOU DO ANYTHING ELSE.

IMPORTANT SAFETY INSTRUCTIONS

When using your telephone equipment, basic safety precautions should always be followed to reduce the risk of fire, electric shock and injury to persons, including the following:

1. Read and understand all instructions.
2. Follow all warnings and instructions marked on the product.
3. Unplug this product from the wall outlet before cleaning. Do not use liquid cleaners or aerosol cleaners. Use a dry cloth for cleaning.
4. Do not use this product near water sources, such as bath tubs, wash bowls, kitchen sinks, laundry tubs, wet basements, or swimming pools.
5. Do not place this product on an unstable cart, stand, or table. The telephone may fall, causing serious damage to the telephone.
6. Slots and openings in the cabinet and the back or bottom are provided for ventilation, to protect the phone from overheating. These openings must not be blocked or covered. The openings should never be blocked by placing the product on a bed, sofa, rug, or other similar surface. This product should never be placed near or over a radiator or heat register. This product should not be placed in a built-in installation unless proper ventilation is provided.
7. This product should be operated only from the type of power source indicated on the marking label. If you are not sure of the type of power supply to your home, consult your dealer or local power company.
8. Do not allow anything to rest on the power cord. Do not locate this product where the cord will be abused by persons walking on it.
9. Do not overload wall outlets and extension cords as this can result in the risk of fire or electric shock.
10. Never push objects of any kind into this product through cabinet slots as they may touch dangerous voltage points or short out parts that could result in a risk of fire or electric shock. Never spill liquid of any kind on the product.
11. To reduce the risk of electric shock, do not disassemble this product, but take it to qualified service personnel when some service or repair work is required. Opening or removing covers may expose you to dangerous voltages or other risks. Incorrect reassembly can cause electric shock when the appliance is subsequently used.
12. Unplug this product from the wall outlet and refer servicing to qualified service personnel under any of the following conditions:
 - A. When the power supply cord or plug is damaged or frayed.
 - B. If liquid has been spilled into the product.
 - C. If the product has been exposed to rain or water.
 - D. If the product does not operate normally by following the operating instructions. Adjust only those controls that are covered by the operating instructions because improper adjustment of other controls may result in damage and will often require extensive work by a qualified technician to restore the product to normal operation.
 - E. If the product has been dropped or the cabinet has been damaged.
 - F. If the product exhibits a distinct change in performance.

13. Do not use the telephone in the vicinity of a gas leak.

CAUTION: TO REDUCE THE RISK OF FIRE OR INJURY TO PERSONS BY THE BATTERY, READ AND FOLLOW THESE INSTRUCTIONS.

1. Use only the appropriate type and size battery pack specified in the instruction manual provided for this product.
2. Do not dispose of the battery pack in a fire. The cell may explode. Check with State and local codes for possible special disposal instructions.
3. Do not open or mutilate the battery pack. Released electrolyte is corrosive and may cause damage to the eyes or skin. It may be toxic if swallowed.
4. Exercise care in handling the battery in order not to short it with conducting materials such as rings, bracelets, and keys. The battery or conductor may overheat and cause burns.
5. Charge the battery pack provided with or identified for use with this product only in accordance with the instructions and limitations specified in the instruction manual provided for this product.
6. Observe proper polarity orientation between the battery pack and the battery charger.

ATTENTION: THE PRODUCT THAT YOU HAVE PURCHASED CONTAINS A RECHARGEABLE BATTERY. UNDER VARIOUS STATE AND LOCAL LAWS, IT MAY BE ILLEGAL TO DISPOSE OF THIS BATTERY INTO THE MUNICIPAL WASTE STREAM. PLEASE CHECK WITH YOUR LOCAL GOVERNMENT FOR DETAILS IN YOUR AREA FOR RECYCLING OPTIONS OR PROPER DISPOSAL.

SAVE THESE INSTRUCTIONS

TO HELP PROTECT THE ENVIRONMENT, THIS PRODUCT MAY CONTAIN RECYCLED OR RECONDITIONED PARTS AND MATERIALS.

The RBRC™ Seal



The RBRC™ Seal on the (easily removable) nickel-cadmium battery (contained in our product) indicates that Toshiba America Consumer Products, Inc. (TACP) is voluntarily participating in an industry program to collect and recycle these batteries at the end of their useful lives, when taken out of service within the United States. The RBRC™ program provides a convenient alternative to placing used nickel-cadmium batteries into the trash or municipal waste, which is illegal in some areas.

TACP's payments to RBRC™ make it easy for you to drop off the spent battery at local retailers of replacement nickel-cadmium batteries, or at authorized TACP product service centers. You may also contact your local recycling center for information on where to return the spent battery. Please call 1-800-8-BATTER for information on Ni-Cd battery recycling in your area. TACP's involvement in this program is part of its commitment to protecting our environment and conserving natural resources.

RBRC™ is a trademark of Rechargeable Battery Recycling Corporation.

SERVICE REQUIREMENTS

If the cordless telephone should malfunction, or need changes or modifications, all repairs will be performed by an authorized Toshiba Service Station. This unit has been registered with the FCC for direct connection to the telephone network. Under the FCC program, no customer is authorized to repair this unit. This applies to a unit both in and out of warranty. If an unauthorized repair is performed, the registration of the unit for direct connection to the network will be null and void. If the unit is still in warranty, the remainder of the warranty period will also be null and void.

It is the responsibility of users requiring service to report the need for service to their Toshiba dealer.

IMPORTANT INSTRUCTIONS TO USERS

Your SG-1700 has been designed and constructed to conform to federal regulations and can be connected to the phone line as described in this manual.

Please note that each product connected to the telephone line places a certain load on the line. We designate this as the unit's "Ringer Equivalence Number."

It is most unlikely, but . . . If your SG-1700 should cause problems on the phone line, the phone company has the right to temporarily discontinue your service. If this happens, the phone company will notify you and give you the opportunity to correct the problem. Also, you need to know that the phone company does have the right to make changes in their lines and/or equipment.

If these changes might affect your SG-1700 (or require changes in the SG-1700 or its connection), the phone company will notify you in writing, so you will have the chance to take whatever action is necessary to ensure uninterrupted phone service.

FCC REQUIREMENTS

You are no longer required by the FCC to notify your local telephone company of your intent to connect a new telephone. Your local telephone company may call you and request information about your phone such as: the brand name, model number, registration number, and ringer equivalence number. This information is provided on a label located at the bottom of the base unit and handset.

You may not directly connect your SG-1700 to coin telephone services. Check with your local telephone company if you wish to connect your SG-1700 to a party line service. Some party line services require a special adaptor or modification to your telephone.

Finally, it should be noted that some cordless telephones operate at frequencies that may cause interference to nearby TVs and VCRs; to minimize or prevent such interference, the base of the cordless telephone should not be placed near or on top of a TV or VCR; and, if interference is experienced, moving the cordless telephone farther away from the TV or VCR will often reduce or eliminate the interference.

INTRODUCTION

Toshiba America Consumer Products, Inc. takes pride in presenting the SG-1700, one of the finest digital spread spectrum cordless telephones available. Intelligent design, superb craftsmanship, and the latest technological advances have been combined to provide you with a telephone that is easy to operate and will provide you with years of dependable service. Please take the time now to read your Owner's Manual carefully, so that you may enjoy the many convenient features of your SG-1700 telephone.

FEATURES

- 2.4GHz Digital Spread Spectrum Transmission with Extended Talk Range
- 30-Channel Auto Scanning
- Digital Call Protect Privacy Scrambling and Digital Security Code
- Volume Control (4 level)
- Ringer Volume and Tone Control
- 10 Speed Dial (20 digits)
- Long Standby Battery Life (7 days)
- One Way Page/Handset Locator
- Last Number Redial (32 digits)
- Mute on Handset
- Any-key Answer
- Reversible Charging System
- Hearing Aid Compatible/HAC Volume
- Desk/Wall Mountable (Bracket included)
- Headset Jack

INSTALLATION

1. SETTING UP THE BASE UNIT

For use on a desk or counter top follow the instructions below.

DESKTOP MOUNTING:

Snap the bracket's tab into the notches on the base.

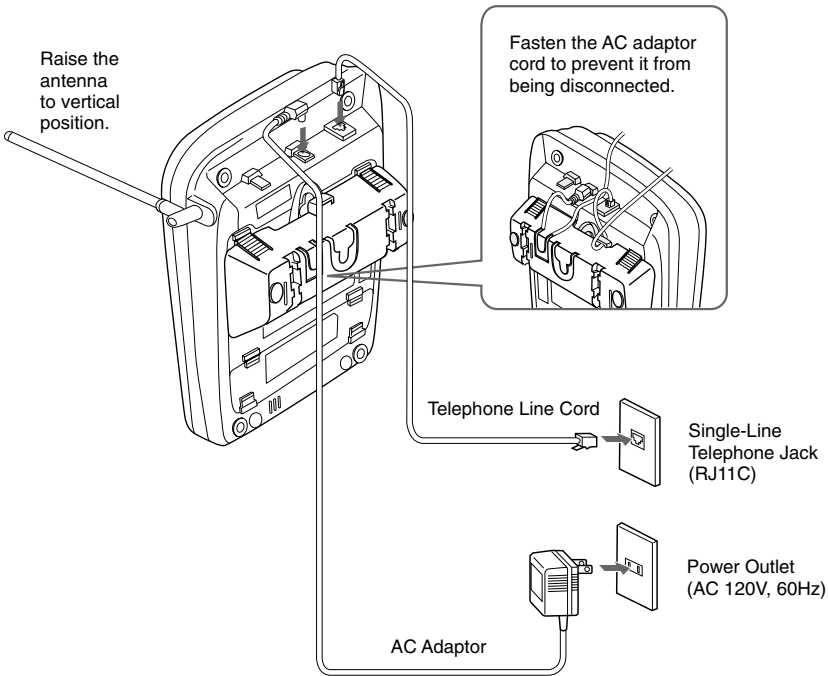
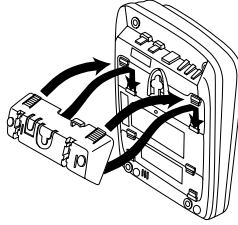

- USE ONLY WITH Supplied AC ADAPTOR (TAC-1700; power source AC 120V, 60Hz/DC 9V).
- The AC adaptor must remain connected at all times. (It is normal for the adaptor to feel warm during use.)

2. CHARGE THE BATTERY PACK

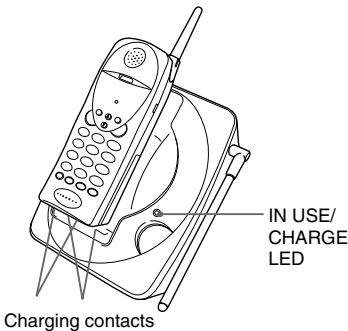
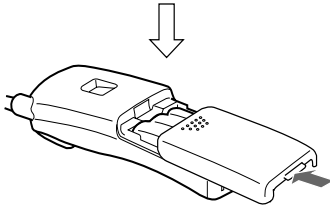
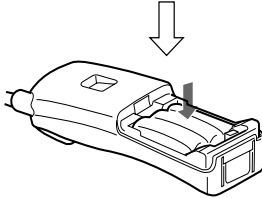
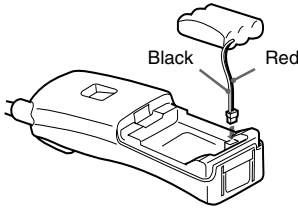

Note

Use only the supplied battery pack (TRB-8000; power source 600 mAh, 3.6V).

- ① Remove the battery compartment cover on the back of the handset by sliding it down.
- ② Plug the battery pack cord into the connector in the battery compartment in correct polarity. It fits in only one way.
- ③ Place the battery pack in the battery compartment.
- ④ Put the battery compartment cover back by sliding until it snaps into place. Make sure not to get the wires of the battery pack caught in the cover.
- ⑤ Place the handset on the base unit. Be sure the IN USE/CHARGE LED lights. If the IN USE/CHARGE LED does not light, make sure the AC adaptor is plugged in securely and that the electrical outlet is working and not controlled by a light switch.

It is important to charge the battery for 12 to 16 hours continuously without any interruption before you use the handset for the first time.

Note

The battery pack is not charged properly if the charging contacts are dirty or tarnished. Clean the contacts occasionally with a dry cloth.

After the battery pack is fully charged;

Operation	Approx. battery life
While in use (Talk mode)	up to 6 hours
While not in use (Standby mode)	up to 7 days

When TALK/BATT LOW LED blinks, all handset buttons are disabled and the battery needs to be charged. If you are during a call, you hear short beeps. Finish the call as soon as possible and place the handset on the base unit.

Note

If a call comes in when the battery is too low to operate properly, you will be unable to answer the call or the call will be disconnected.

WALL MOUNTING

MOUNTING ON A STANDARD WALL PLATE

Insert the bracket's tab into the base's lower tab slots, then press down on the top of the bracket to snap it into the clip slots.

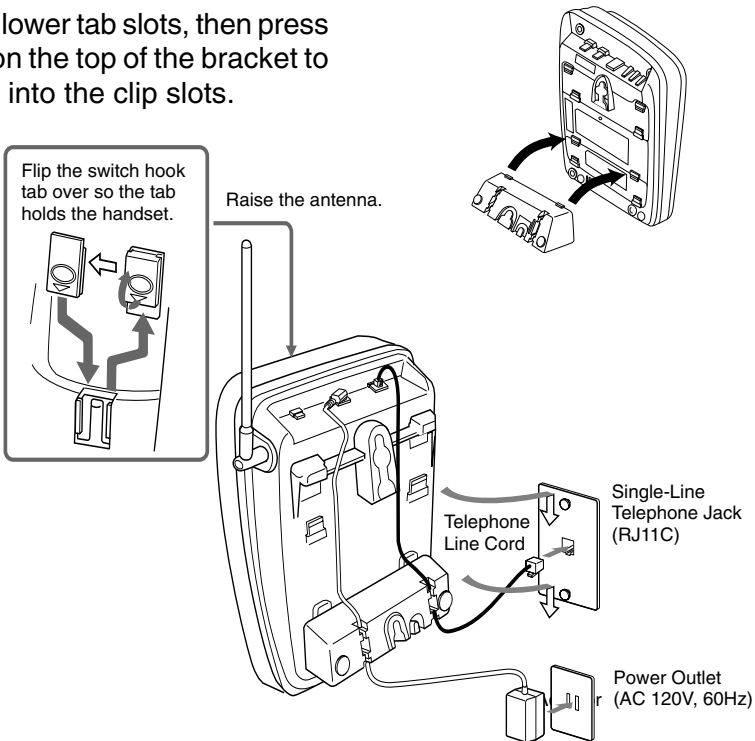

- Route the cords through the guides.
- Place the base unit on the posts of the wall plate and push down until it is firmly seated.
- **USE ONLY WITH Supplied AC ADAPTOR (TAC-1700; power source AC 120V, 60Hz/DC 9V).**

Notes

- Do not use any outlet controlled by a wall switch.
- If you don't have a standard wall plate, cut out the template below and use it to position two screws (minimum length of 1-3/8 inches) into the wall with the heads protruding about 3/16 inch.

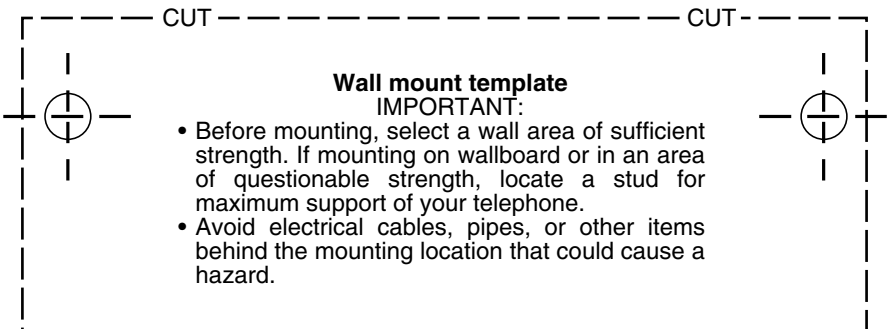

LOCATIONS OF CONTROLS

HANDSET CONTROLS

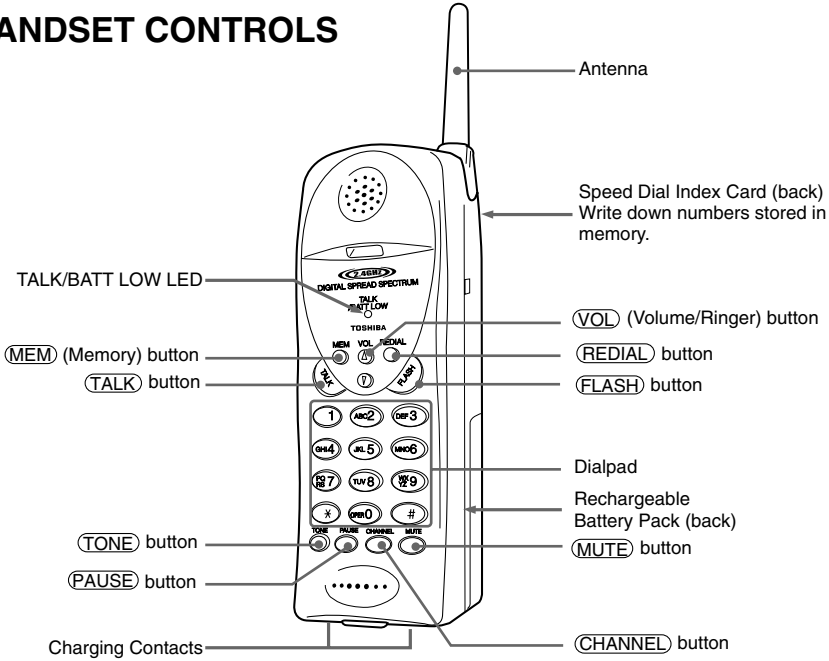

BASE UNIT CONTROLS

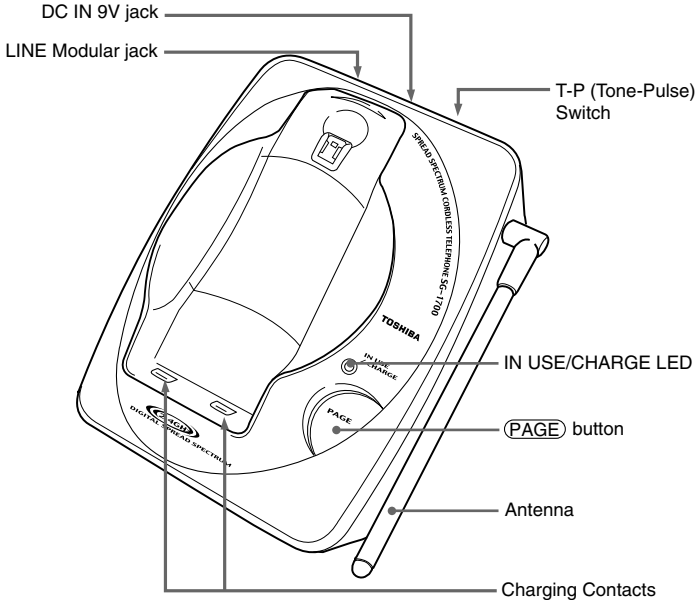

Please see “LOCATION OF CONTROLS” for the location of each button used for the following operations.

TONE/PULSE SETTING

Set the TONE/PULSE switch on the back of the base unit to TONE and make a trial call.

If the call does not connect, set the TONE/PULSE to PULSE.

MAKING A CALL

1. MAKING A CALL

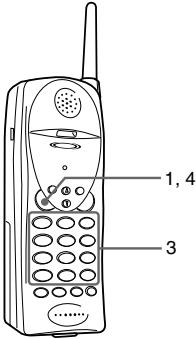

- ① Press **TALK**.
- ② Listen for the dialtone.
- ③ Key in the phone number you are calling.
- ④ To hang up, press **TALK** again or place the handset on the base unit. The TALK/BATT LOW LED turns off.

2. ANSWERING A CALL

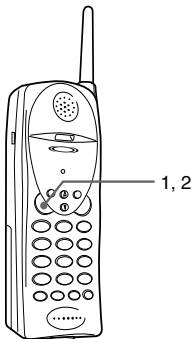

- ① Simply pick up the handset or press any key if the handset is located away from the base unit. The TALK/BATT LOW LED will light.
- ② To hang up, press **TALK** or place the handset on the base unit. The TALK/BATT LOW LED turns off.

3. INTERFERENCE OR STATIC

If you hear noise during a call, press **(CHANNEL)** to select another channel. The TALK/BATT LOW LED blinks during changing a channel.

4. CHANGING THE RINGER VOLUME

Press **(▲/▼)** to select one of four ringer tone and volume combinations during standby mode.

Each time you press **(▲/▼)**, the setting will change.

5. CHANGING THE HANDSET SPEAKER VOLUME

During a telephone call, press **(▲/▼)** to select one of four speaker volume levels; Loud, High, Medium and Low,

The setting will remain in effect even after you hang up the current call.

Note

The Loud setting may be too loud because it is set for hearing aid compatibility.

6. REDIALING

Press **(TALK)** and then press **(REDIAL)**. The last number called (up to 32 digits) will then be dialed again.

7. USING THE CALL WAITING SERVICE, ETC.

To use this feature, you must subscribe to the Call Waiting service.

When you hear a call-waiting tone while you are already talking on the phone, simply press **(FLASH)**.

To take the original call back, press **(FLASH)** again.

Note

Pressing **(FLASH)** without receiving a Call Waiting signal may disconnect the current caller.

8. SENDING TONE SIGNAL (for Pulse service user)

Even if you have Pulse service (the Tone-Pulse switch is set to Pulse). You can use this phone with banking and other phone services requiring touch tone signals.

- ① Dial the service number and wait for the connection.
- ② Press **(TONE)** then, enter the numbers required. You will hear the tones on the line.

9. MUTING

Press **(MUTE)** to turn off the microphone during a conversation.

The TALK/BATT LOW LED blinks. You may speak to someone in the room without the caller overhearing.

To resume normal conversation, press **(MUTE)** or **(TALK)**.

10. PAGING

To locate the handset (while it is off the base), press **(PAGE)** on the base unit. The handset beeps for 30 seconds. To stop paging, press **(PAGE)** or return the handset to the base unit.

Notes

- You cannot page the handset during a call.
- Be careful not to close your ear to the ringer on the back side of the handset while paging, because it may be too loud.

11. OUT OF RANGE

During a call, as you begin to move too far from the base, you first hear a clicking sound. As you travel farther, the noise increases. If you travel out-of-range, your call terminates.

CARRYING THE HANDSET IN THE BELT CLIP

You can attach the Belt Clip to the handset in order to carry it on your belt.

Attaching the Belt Clip to the Handset

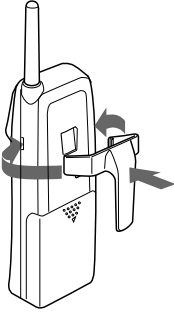

Insert the Belt Clip tabs into the holes on each side of the handset until they click.

Note

Be sure to insert the tab properly into each hole to prevent the belt clip from falling off.

Removing the Belt Clip from the Handset

Pull both sides of the Belt Clip to release the tabs from the holes.

Note

Remove the Belt Clip carefully from the handset, taking care not to hurt your fingers or damage your nails.

USING A HEADSET

You can talk with hands-free convenience using an optional headset (part #. RC008260) that has a 3/32-inch(2.5mm) plug.

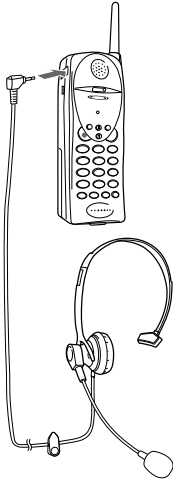

To connect the headset, open the rubber cover on the left side of the handset, then insert the headset's plug into the jack.

With a headset connected, you can make or answer calls as usual using the keys on the handset.

You can use the supplied Belt Clip to hang the handset on your belt for greater convenience.

When you finish using the headset, disconnect it from the handset and close the rubber cover to protect the jack.

Notes

- The handset's earspeaker and microphone are turned off with a headset connected.
- Pressing the ▲/▼ button of the handset also controls the connected headset's volume.
- If you place the handset on the base unit while the headset is connected, be sure the handset is placed properly.

MEMORY DIALING

You can store up to 10 telephone numbers in memory.

Notes

In memory dialing operation,

- If more than 20 seconds elapse between pressing buttons, the operation will be cancelled and you must start over again.
- If you press a wrong button, an error tone sounds and the handset returns to standby mode.
- If a call comes in, the operation will be canceled and you will hear the ring.

1. STORING NUMBERS

You can store up to 20 digits including #, *, TONE, and PAUSE in one memory address.

- ① Pick up the handset from the base unit. (Do not press **TALK**.)
- ② Press **MEM**.
- ③ Dial the telephone number you wish to store. (up to 20 digits).
- ④ Press **MEM**.
- ⑤ Enter the memory address (0 to 9) at which you wish to store the phone number stored in step 3.

You will hear a long beep when the number is successfully stored.

To store more telephone numbers, repeat the steps from ② to ⑤.

- ⑥ Return the handset to the base unit.
- ⑦ Record the telephone numbers on the SPEED DIAL INDEX CARD, and place it on the back of the handset.

EXAMPLE: To store 9012345 in memory address 3

MEM 9 0 1 2 3 4 5 **MEM** 3

Replacing a telephone number

Just store the new number following the same steps in “1. STORING NUMBERS.”

The new number will replace the previously stored one.

2. DIALING A STORED NUMBER

- ① Pick up the handset and press **(TALK)**.

The TALK/BATT LOW LED lights.

- ② Press **(MEM)**.
- ③ Enter the memory address (0 to 9).

The stored number will be dialed.

Note

If you enter a memory address which does not have any stored number, error beeps sound.

3. ERASING A STORED TELEPHONE NUMBER

- ① Pick up the handset. (Do not press the **(TALK)** button.)
- ② Press the **(MEM)** button twice.
- ③ Enter the memory address button (0 to 9) you wish to erase.

When erasing is completed, you will hear a long beep.

4. INSERTING A PAUSE IN MEMORY

Use **(PAUSE)** to make an outgoing call through a PBX or long distance. Each time you press **(PAUSE)**, a pause of about two seconds is inserted during the dialing sequence. If more than two seconds are needed, press **(PAUSE)** twice.

EXAMPLE: To store "0 **(PAUSE)** 1234567890" in memory address 4, press:

(MEM) **(0)** **(PAUSE)** **(1)** **(2)** **(3)** **(4)** **(5)** **(6)** **(7)** **(8)** **(9)** **(0)** **(MEM)** **(4)**

5. CHAIN DIALING

Combining ordinary dialing and memory dialing, you can dial a long telephone number with less steps.

EXAMPLE: Divide the number into two portions and store the first portion in memory address 1 and the second portion in memory address 2. When you call, press following buttons;

(TALK) **(MEM)** **(1)** **(MEM)** **(2)**

ACCESSORIES

SUPPLIED ACCESSORIES

Rechargeable Battery pack	(1) TRB-8000 Part #. RC004931
AC Adaptor	(1) TAC-1700 Part #. RC009258
Telephone Cord	(1) Part #. RC008231
Belt Clip	(1) Part #. RC009263
Owner's Manual	(1) Part #. RC009259
Speed Dial Index	(1) Part #. RC009264
Bracket	(1) Part #. RC009262

OPTIONAL ACCESSORIES

Headset	(1) Part #. RC008260
---------	----------------------

For the purchase of Accessories, please call 1-877-644-7373.

TROUBLESHOOTING GUIDE

Should any problem occur with the set, make the following simple tests to determine whether or not servicing is required.

PROBLEM	SOLUTION
No dial tone. No calls come in.	•The AC adaptor of the base unit is disconnected. →Plug the AC adaptor into the base unit and the AC 120V outlet.
	•The battery is low. →Place the handset on the base unit to recharge.
	•Telephone line cord is disconnected. →Check both ends of the telephone jack.
	•The previous call was not disconnected. →Press TALK to disconnect the line.
	•Trouble with the telephone line. →Check an extension line.
	•Outlet used is controlled by a wall switch in its OFF position. →Relocate to another outlet.
	•The digital security code is changed. →Disconnect the power and remove the handset. After a few seconds, restore the power and place the handset on the base for at least 3 seconds.
	•The handset is too far from the base unit. →Bring the handset near the base unit.
	•You press the button while the handset is on the base unit's charging cradle. →Pick up the handset from the base unit before you press TALK .

PROBLEM	SOLUTION
Noise or interference.	<ul style="list-style-type: none"> •The handset is too far from the base unit. →Bring the handset near the base unit.
	<ul style="list-style-type: none"> •The battery is low. →Place the handset on the base unit to recharge.
	<ul style="list-style-type: none"> •The base unit is located in a place with high interference. →Relocate to another outlet.
	<ul style="list-style-type: none"> •Interference from TV, appliances, etc. →Press CHANNEL to select a clearer channel, or relocate the base unit.
	<ul style="list-style-type: none"> •There may be line noise. →Check with another telephone.
	<ul style="list-style-type: none"> •The volume control is set too high. →Reduce volume to lower setting.
	<ul style="list-style-type: none"> •The base antenna is not in a vertical position. →Lift the antenna to a vertical position.
Battery goes low quickly.	<ul style="list-style-type: none"> •The battery was not fully charged at the initial charging. →Charge the battery for 12 to 16 hours without any interruption.
	<ul style="list-style-type: none"> •The battery is several years old. →Replace with a new battery.
The handset battery does not charge.	<ul style="list-style-type: none"> •The battery is not installed correctly. →Install the battery correctly.
	<ul style="list-style-type: none"> •The charging contacts of the handset and base are not clean. →Clean them with a dry cloth.
	<ul style="list-style-type: none"> •The battery is several years old. →Replace with a new battery.
The unit operates abnormally.	<ul style="list-style-type: none"> •The phone needs to be reset. →Disconnect the AC adaptor and reconnect it after a few seconds.
TALK/BATT LOW LED blinks. The operation is stopped.	<ul style="list-style-type: none"> •The battery is low. →Recharge the battery.
When the handset is returned to the base unit with the volume level set at High, a momentary squeal or howling sound may sometimes be heard.	<ul style="list-style-type: none"> •This is normal. →It may be prevented by changing the volume setting to Medium or Low before returning the handset to the base unit.

WARRANTY/SERVICE

TELEPHONE/TELEPHONE ANSWER MACHINE LIMITED WARRANTY

Toshiba America Consumer Products, Inc. ("TACP") and Toshiba Hawaii, Inc. ("THI") make the following limited warranties. These limited warranties extend to the original consumer purchaser or any person receiving this set as a gift from the original consumer purchaser and to no other purchaser or transferee.

Limited One(1) Year Warranty of Labor and parts

TACP/THI warrant this product and its parts against defects in materials or workmanship for a period of one(1) year after the date of original retail purchase. During this period, TACP/THI will repair or replace your defective product with a new or refurbished unit at our option.

Owner's Manual

You should read the owner's manual thoroughly before operating this product.

Your Responsibility

The above warranties are subject to the following conditions.

- (1) You must provide a copy of your bill of sale or other proof of purchase.
- (2) These warranties are effective only if the product is purchased and operated within the USA or Puerto Rico.

(3) Within the continental U.S.A., if you should find a defective product within the warranty period please call 1-877-644-7373.

(4) Warranties extend only to defects in materials or workmanship as limited above and do not extend to any product or parts which have been lost or discarded by you, or to damage to products or parts caused by misuse, accident, damage caused by Acts of God, such as lightning or fluctuations in electric power, improper installation, improper maintenance or use in violation of instructions furnished by us; or to units which have been altered or modified without authorization of TACP/THI, or to damage to products or parts thereof which have had the serial number removed, altered, defaced or rendered illegible.

(5) Physically damaged products are not acceptable for repair or exchange within or after the warranty period expires.

How to Obtain Warranty Service

In the event a problem should develop with your product, please proceed as follows:

In The Continental United States contact:

<http://www.toshiba.com/tacp>

In Hawaii contact:

Toshiba Hawaii, Inc.
327 Kamakee Street,
Honolulu, HI 96814
(808)-591-8377

All warranties implied by state law, including the implied warranties of merchantability and fitness for a particular purpose, are expressly limited to the duration of the limited warranties set forth above. With the exception of any warranties implied by state law as hereby limited, the foregoing warranty is exclusive and in lieu of all other warranties, guarantees, agreements and similar obligations of manufacturer or seller with respect to the repair or replacement of any parts. In no event shall TACP/THI be liable for consequential or incidental damages.

No person, agent, distributor, dealer or company is authorized to change, modify or extend the terms of these warranties in any manner whatsoever. The time within which an action must be commenced to enforce any obligation of TACP/THI arising under the warranty or under any statute, or law of the United States or any state thereof, is hereby limited to ninety(90) days from the date you discover, or should have discovered, the defect. This limitation does not apply to implied warranties arising under state law.

This warranty gives you specific legal rights and you may also have other rights which may vary from state to state. Some states do not allow limitation on how long an implied warranty lasts, when an action may be brought, or the exclusion or limitation of incidental or consequential damages, so the above provisions may not apply to you.