

# Chapter 1 Command Summary

## Basic AT Commands

### Command Function

A/	Re-execute command.
A	Go off-hook and attempt to answer a call
B0	Select V.22 connection at 1200 bps.
B1	Select Bell 212A connection at 1200 bps
C1	Return OK message.
Dn	Dial modifier.
E0	Turn off command echo
E1	Turn on command echo
H0	Initiate a hang-up sequence
H1	If on-hook, go off-hook and enter command mode.
I0	Report product code
I1	Report computed checksum
I2	Report OK
I3	Report firmware revision, model, date
I4	Report response programmed by an OEM.
I5	Report the country code parameter.
I6	Report modem data pump model
L0	Set low speaker volume
L1	Set low speaker volume
L2	Set medium speaker volume
L3	Set high speaker volume
M0	Turn speaker off
M1	Turn speaker on during handshaking and turn speaker off while receiving carrier
M2	Turn speaker on during handshaking and while receiving carrier
M3	Turn speaker off during dialing and receiving carrier and turn speaker on during answering.
N0	Turn off Auto mode detection
N1	Turn on Auto mode detection
O0	Go on-line
O1	Go on-line and initiate a retrain sequence.
P	Force pulse dialing
Q0	Allow result codes to DTE
Q1	Inhibit result codes to DTE
Sn	Select S-Register as default
Sn?	Return the value of S-Register n.
Sn = v	Set default S-Register to value v.
S = ?	Return the value of default S-Register
T	Force DTMF dialing.
V0	Report short from (terse) result codes.
V1	Report long from (verbose) result codes.
W0	Report DTE speed in Error Correction mode.
W1	Report line speed, Error Correction protocol and DTE speed.
W2	Report DCE speed in Error Correction mode.
X0	Report basic call progress result codes, i.e., OK, CONNECT, RING, NO CARRIER (also , for busy, if enabled, and dial tone not detected), NO ANSWER and ERROR
X1	Report basic call progress result codes and connections speeds (OK, CONNECT, RING, NO CARRIER (also, for busy, if enabled, and dial tone not detected), NO ANSWER, CONNECT, XXXX, and ERROR.
X2	Report basic call progress result codes and connections speeds, i.e., OK, CONNECT, RING, NO CARRIER (also, for busy, if enabled, and dial tone not detected), NO ANSWER, CONNECT, XXXX, and ERROR
X3	Report basic call progress result codes and connection rate, i.e., OK, CONNECT, RING, NO CARRIER, NO ANSWER, CONNECT, XXXX, BUSY, and ERROR.
X4	Report all call progress result codes and connection rate, i.e., OK, CONNECT, RING, NO CARRIER, NO ANSWER, CONNECT XXXX, BUSY, NO DIAL TONE and ERROR.
Y0	Disable long space disconnect before on-hook.
Y1	Enable long space disconnect before on-hook.
Z0	Restore stored profile 0 after warm reset.
Z1	Restore stored profile 1 after warm reset.
&C0	Force RLS(D) active regardless of the carrier state.
&C1	Allow RLS(D) to follow the carrier state.
&D0	Interpret DTR ON - to - OFF transition per &Qn.
&D1	Interpret DTR ON - to - OFF transition per &Qn.
&D2	Interpret DTR ON - to - OFF transition per &Qn
&D3	Interpret DTR ON - to - OFF transition per &Qn
&F0	Restore factory configuration 0

&F1 Restore factory configuration 1.  
 &G0 Disable guard tone.  
 &G1 Disable guard tone.  
 &G2 Enable 1800 Hz guard tone.  
 &K0 Disable DTE/DCE flow control  
 &K3 Enable RTS/CTS DTE/DCE flow control  
 &K4 Enable XON/XOFF DTE/DCE flow control  
 &K5 Enable transparent XON/XOFF flow control.  
 &K6 Enable both RTS/CTS and XON/XOFF flow control  
 &M0 Select direct asynchronous mode.  
 &M1 Select sync connect with async off-line command mode. \*  
 &M2 Select sync connect with async off-line command mode and Enable DTR dialing of directory zero.\*  
 &M3 Select sync connect with async off-line command mode and Enable DTR to act as Talk/Data switch \*  
 &P0 Set 10 pps pulse dial with 39% 61% make/break. (country dependent)  
 &P1 Set 10 pps pulse dial with 33%67% make/break.  
 &P2 Set 20 pps pulse dial with 39% 61% make/break.  
 &P3 Set 20 pps pulse dial with 33% 67% make/break.  
 &Q0 Select direct asynchronous mode.  
 &Q1 Select sync connect with async off-line command mode. \*  
 &Q2 Select sync connect with async off-line command mode and Enable DTR dialing of directory zero. \*  
 &Q3 Select sync connect with async off-line command mode and Enable DTR to act as Talk/Data switch.  
 &Q4 Select Hayes AutoSync mode.  
 &Q5 Modem negotiates an error corrected link  
 &Q6 Select asynchronous operation in normal mode.  
 &R0 CTS tracks RTS (async) or acts per V.25 (sync)  
 &R1 CTS is always active.  
 &S0 DSR is always active.  
 &T0 Terminate any test in progress  
 &T1 Initiate local analog loopback.  
 &T2 Returns ERROR result code  
 &T3 Initiate local digital loopback.  
 &T4 Allow remote digital loopback.  
 &T5 Disallow remote digital loopback request  
 &T6 Request an RDL without self-test  
 &T7 Request an RDL with self-test  
 &T8 Initiate local analog loop with self-test.  
 &V0 Display current configurations.  
 &V1 Display the last connection statistics  
 &W0 Store the active profile in NVRAM profile 0  
 &W1 Store the active profile in NVRAM profile 1.  
 &X0 Select internal timing for the transmit clock \*  
 &X1 Select external timing for the transmit clock \*  
 &X2 Select slave receive timing for the transmit clock \*  
 &Y0 Recall stored profile 0 upon power up.  
 &Y1 Recall stored profile 1 upon power up  
 &Zn = x Store dial string x = (1 to 45) to location n= (0 to 3)  
 %E0 Disable line quality monitor and auto retrain.  
 %E1 Enable line quality monitor and auto retrain  
 %E2 Enable line quality monitor and fallback/fall forward.  
 %E3 Enable line quality monitor and auto-retrain with fast hang-up  
 %L Return received line signal level.  
 %Q Report the line signal quality  
 \Kn Controls break handing three states.  
 \N0 Select normal speed buffered mode  
 \N1 Select direct mode.  
 \N2 Select reliable link mode.  
 \N3 Select auto reliable mode.  
 \N4 Force LAMP mode  
 \N5 Force MNP mode  
 +MS Select modulation , (select data speed)

\*: OPTIONAL

# Chapter 2 Specification of Modem

## Specification of External Modem

- Line Data Rate : 56K/54K/52K/50K/48K/56K/44K/42K/40K/38K/36K/34K/  
33.6K/31.2K/28.8K/26.4K/24K/21.6K/19.2K/14.4K/12K/9.6K/  
7.2K/4.8K/2.4K/1.2K/300/75bps
- Modem Protocol : ITU-T V.90, K56Flex, ITU-T V.34bis/ V.34/ V.32bis/ V.32/V.23/  
V.22bis/ V.22/ V.21
- Voice modem : Full-duplex speaker phone (optional)  
Audio span (optional)  
ASVD (optional)
- Fax Compatibility : 14400bps send/receive, G3 compatible
- Software Compatibility : AT Command set compatible
- Fax Command : EIA Class 1 command compatible
- Error Correction : MNP 2-4 and V.42
- Data Compression : MNP 5 and V.42bis
- Data Format : Serial, Binary, Asynchronous 7 or 8 data bits, odd, even or no  
parity one or two stop bit, totally 10 bits length
- DTE TO Modem Data Rate : MAX. 115200bps
- Operation : Dial-Up
- Data Interface : RS-232C compatible
- Dialing : Touch Tone
- Audio Monitoring : Mini speaker with programmable volume control
- Line Interface : RJ-11 modular jack, LINE/PHONE
- Power input : AC power adapter 1A, 9VAC/PLUG 2.5mm

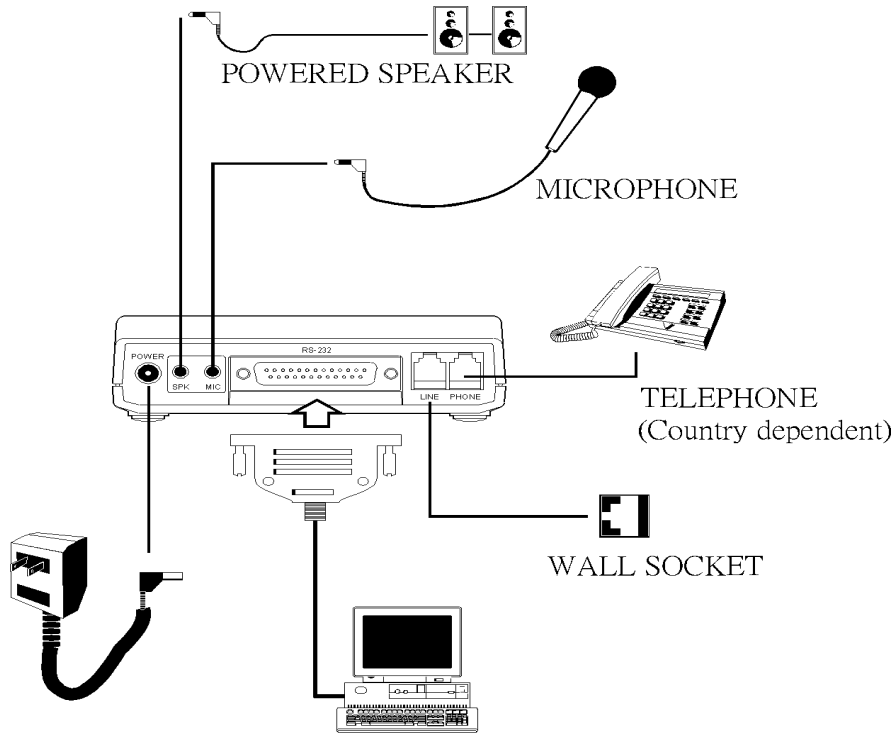

External Modem Diagram

### RS-232C Connector

Pin	Signal	Direction
2	TD	To modem
3	RD	To DTE
4	RTS	To modem
5	CTS	To DTE
6	DSR	To DTE
7	GND	
8	DCD	To DTE
20	DTR	To modem
22	RI	To DTE

# Power switch

Power ON/OFF control

# LED Indicators

- PWR : Indicates the power is on
- MR : Indicates the modem is ready for using
- DTR : Indicates the DTR signal is active
- AA : Indicates the modem is at auto answer mode
- HS : Indicates the modem is at higher speed
- OH : Indicates the line is hook-off
- CD : Indicates the data carrier is detected and the on-line mode
- TD : Indicates the data or command is transmitting
- RD : Indicates data is receiving or command is echoing

# Specifications of Internal Modem

- Line Data Rate : 56K/54K/52K/50K/48K/46K/44K/42K/40K/38K/36K/34K/\*  
33.6K/31.2K/28.8K/26.4K/24K/21.6K/19.2K/14.4K/12K/9.6K/7.2  
K /14.8K/2.4K/1.2K/300/75bps
- Modem Protocol : ITU-T V.90, K56Flex, ITU-T V.34bis/ V.34/ V.32bis/ V.32/V.23/  
V.22bis/ V.22/ V.21
- Voice : Full-duplex speaker phone (optional)  
Audio span (optional)  
ASVD (optional)
- Fax Compatibility : 14400 bps send/receive, G3 compatible
- Software Compatibility : AT Command set compatible
- Fax Command : EIA Class 1 command compatible
- Error Correction : MNP 2-4 and V.42
- Data Compression : MNP 5 and V.42bis
- Data Format : Serial, Binary, Asynchronous 7 or 8 data bits, odd, even or no  
parity one or two binary serial synchronous stop bit, totally 10 bits  
length
- DTE to Modem Data Rate : MAX. 115200bps
- Operation : Dial-Up
- Data Interface : ISA Bus compatible
- Dialing : Touch Tone
- Audio Monitoring : Mini speaker with programmable volume control
- Line Interface : RJ-11 modular jack

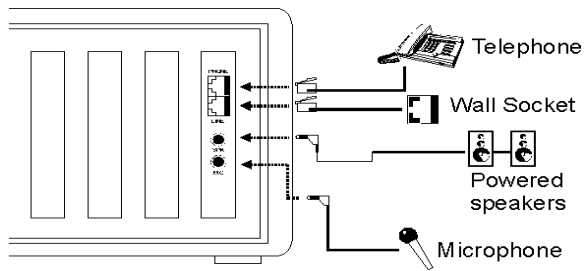
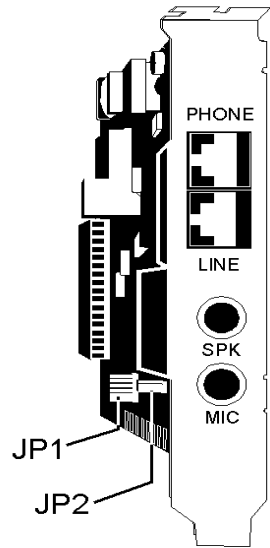

Internal Modem Diagram

## Jumper Setting For Comport Selection

plug and play & Non plug and play

### 1.Plug and Play Enable:

If the computer BIOS or operating system provides support for plug and play

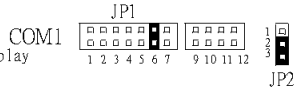

### 2.Disable PnP Setting: (Non PnP Setting)

Determine a free COM port and IRQ,setting Jumper to match free COM and IRQ.

#### 2-1.COM port Selection:

Determine a free COM port,setting Jumper to match free COM.

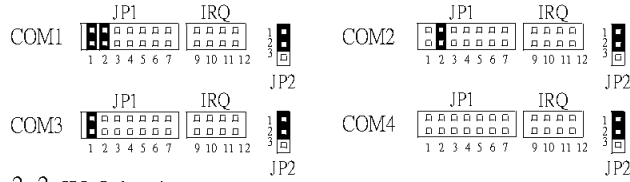

#### 2-2. IRQ Selection:

In addition to setting the COM port, one IRQ must be assigned for the modem.

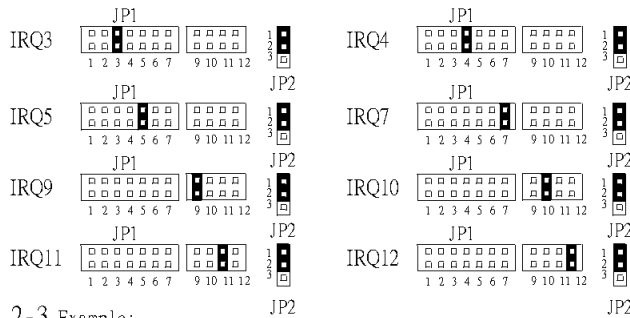

#### 2-3.Example:

COM	address/IRQ	JP1 / JP2	Remark
COM1	3F8~3FF/IRQ4		*1.not recommend
COM2	2F8~2FF/IRQ3		*2.recommend
COM3	3E8~3EF/IRQ5		COM3, IRQ5
COM4	2E8~2EF/IRQ7		COM4, IRQ7

\*1.Normally used by mouse.

\*2.Note: Disable your Mother Board BIOS COM2.

JP4: For selection speaker output or microphone input.  
Because sound card have to different type

1)

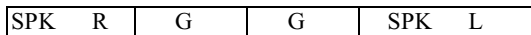

2)

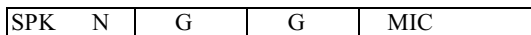

Pin	Signal Defination
MIC	Microphone Input
Comm	Comman
SPK	Speaker Output

Selection microphone input

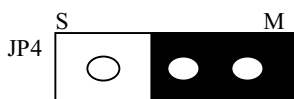

Selection Speaker output



If the jumper setting all correct, than modem can shell microphone and speaker with sound card.

## Chapter 3 Installation procedure for modems

### 3.1. Connecting modem to your computer

#### 3.1.1 External modem

With the computer switched off, plug the modem into an available COM port (usually COM 2) using the supplied data cable. Insert the supplied phone cord into the line jack on the rear of the modem, and the phone plug into the wall socket. Insert the power adapter into the power socket on the rear of the modem.

Ensure that the modem powers up correctly when switched on by observing that the power light (market PWR) on the modem lights. Proceed to Software installation.

#### 3.1.2. Internal modem

- . See addendum sheet for internal modem jumper setting.
- . Remove the computer case and insert the modem card into a spare 16-bit ISA expansion slot.
- . Close the case.
- . Insert the supplied phone cord into the line jack on the rear of the modem, and the phone plug into the wall socket.
- . Proceed to Software installation.

### 3.2. Installing Modem Drivers in Windows 95A/95B/98

#### 3.2.1. Internal modem with Plug and Play setting enable

Switch on your computer, and allow the system to boot to Windows 95. The modem should be auto-detected by Windows 95/98 Plug and Play.

#### In Windows 95A: ( if your Windows 95 is version A)

- (1) Insert the driver disk supplied with the modem into the Floppy or CD-ROM drive and choose *Driver from disk provided by hardware manufacturer*, then click *OK*.

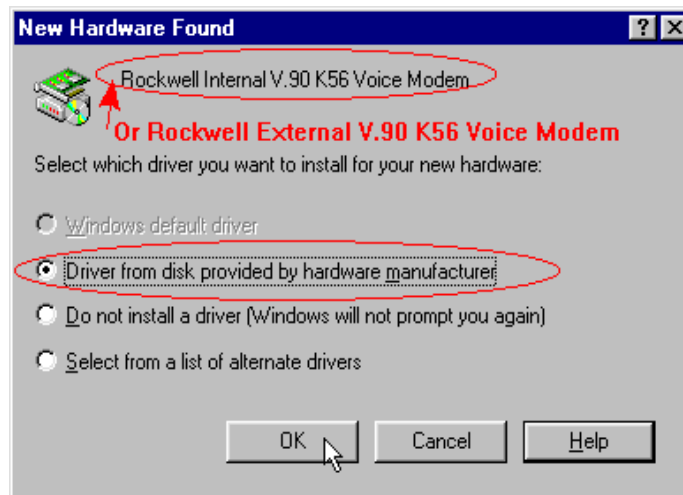

- (2) Use *Browse* to select or type in the drive letter of Floppy or CD-ROM (example: *A:\* or *D:\*) in the box and click *OK*.



(3) If you install **External** modem, please select **Rockwell External V.90 K56 Voice Modem** and click **OK**.

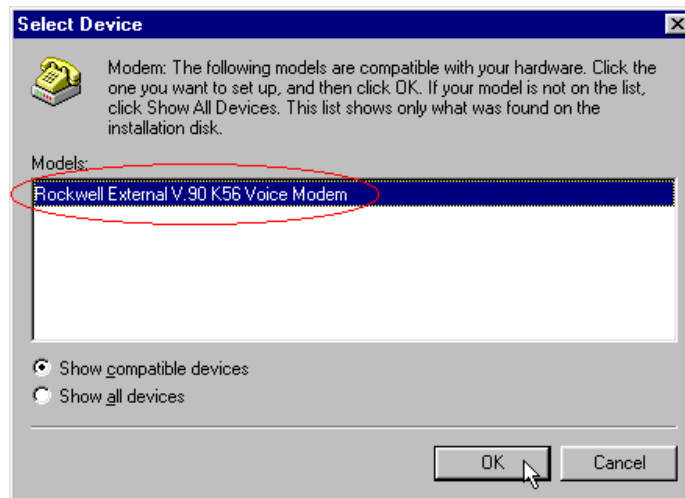

### In Windows95B(OSR2): ( if your Windows 95 is version B)

(1) Click **Next**.

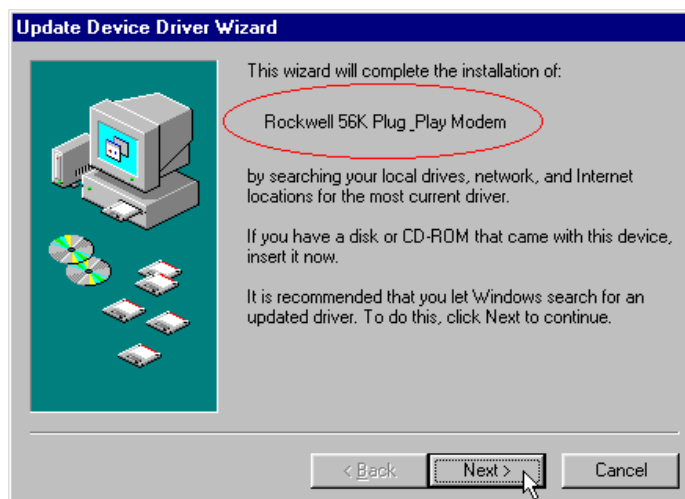

(2) Windows will find the updated driver for **Rockwell External (or Internal) V.90 K56 Voice Modem** , then click **Finish**.

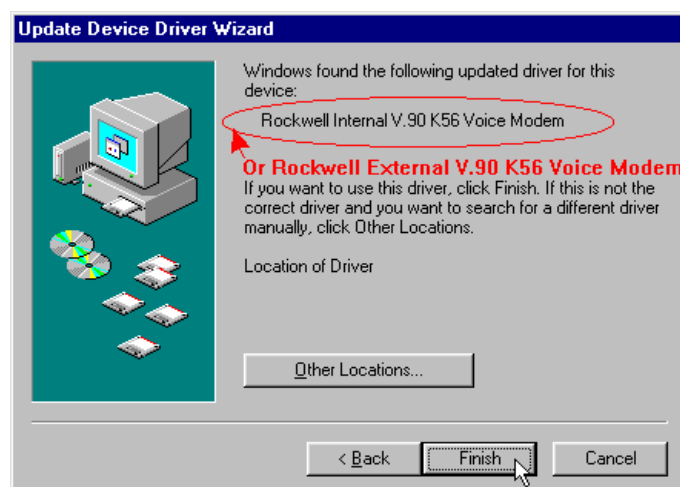



(3) Click *Next*.

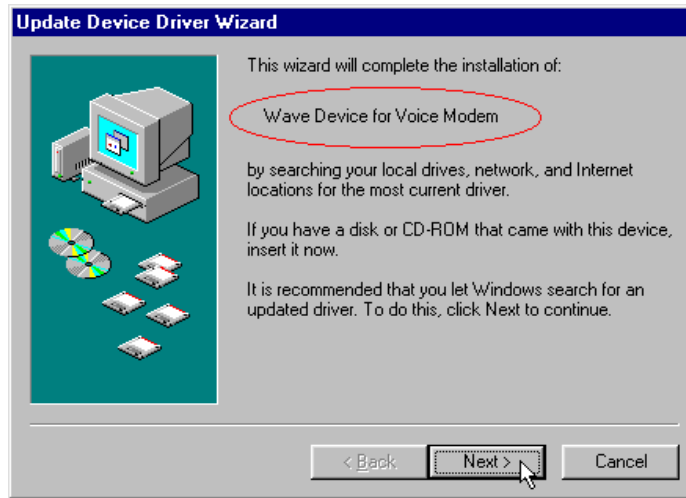

(4) Windows will find the updated driver for *Rockwell Voice Modem Serial Wave Device*, then click *Finish*.



### In Windows 98: ( if your Windows system is 98)

(1) Click *Next*.

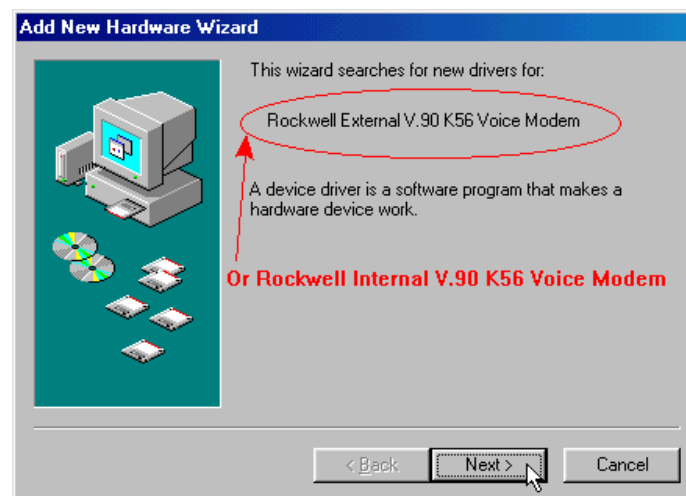

(2) Click *Next*.



(3) Select *Floppy disk drives* or *CD-ROM drive* and click *Next*.



If use floppy, select "Floppy disk drives"

(4) Windows will find *Rockwell External (or Internal) V.90 K56 Voice Modem*, then click *Next*.

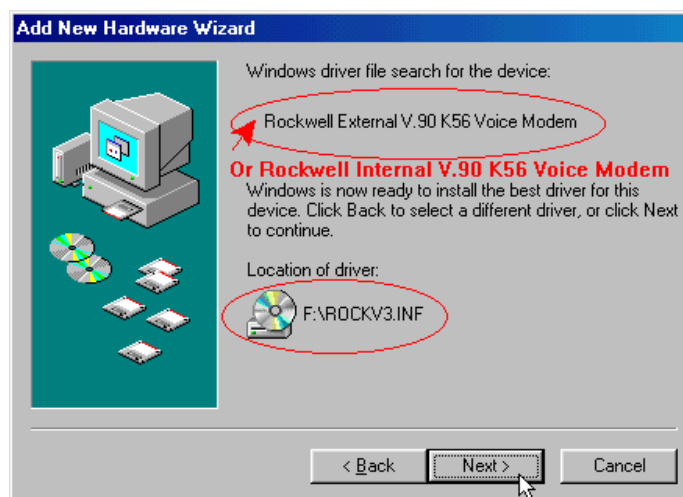

(5) Click **Finish**.

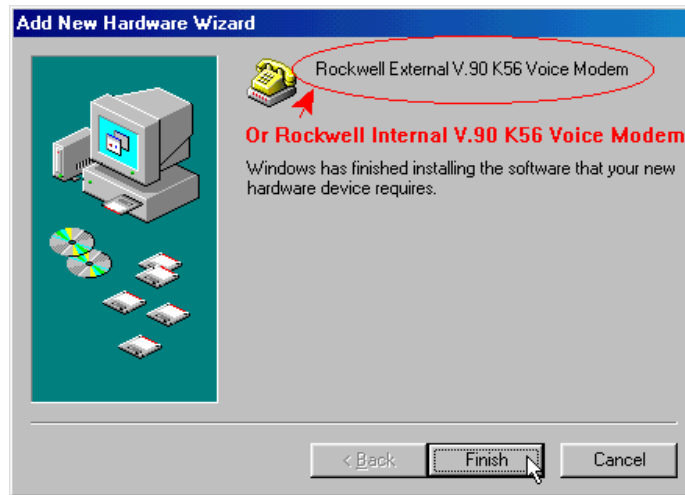

(6) Windows will detect **Wave Device for Voice Modem**.

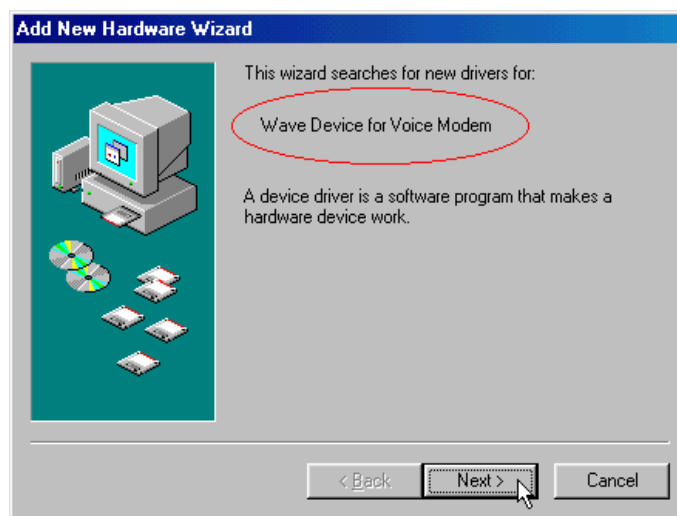

(7) Select **Search for the best driver for your device (Recommended)** and click **Next**.



(8) Select *Floppy disk drives* or *CD-ROM drive* and click *Next*.

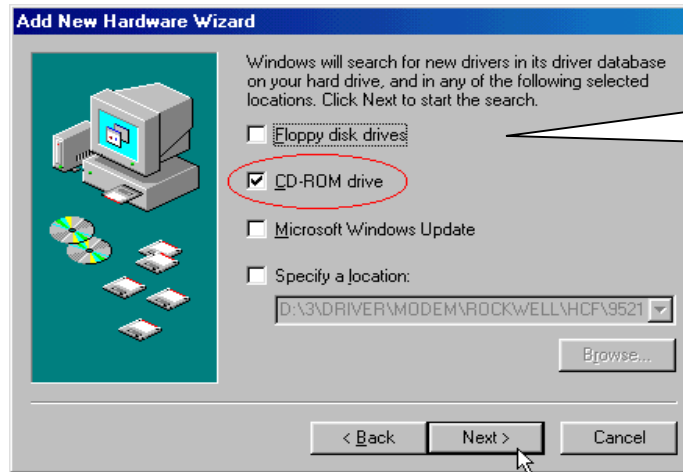

If use floppy, select  
"Floppy disk drives"

(9) Windows will find *Rockwell Voice Modem Serial Wave Device*.

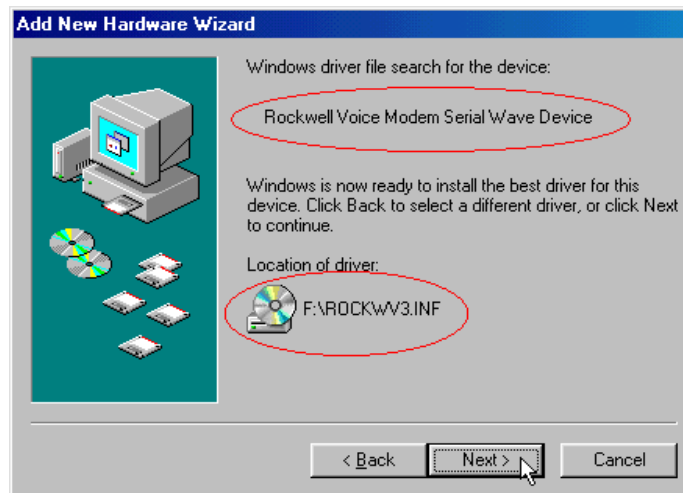

(10) Click *Finish*.

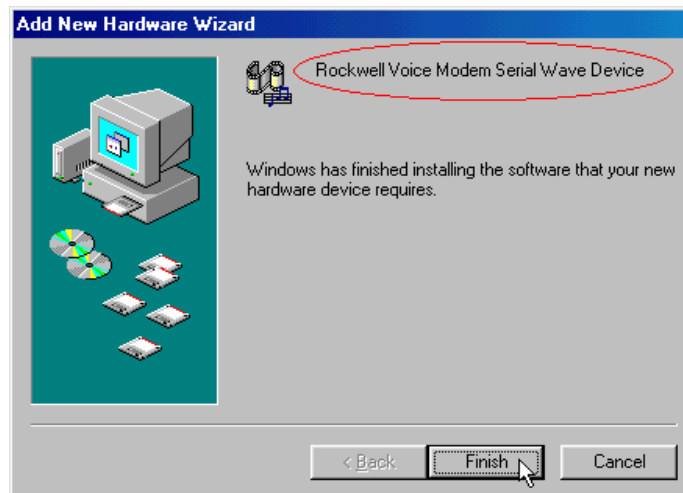

### 3.2.2. Internal Modem with “Plug and Play” setting disable

Special procedure must be followed to install Non Plug and Play internal modem.

Please see the *Hardware installation* to setup the jumpers for Plug and Play.

(If you want to set the modem in COM2/IRQ3, please disable the BIOS of Serial port 2)

(1) Please go to *Start > Settings > Control Panel* and double-click on *the Add New Hardware* icon.



(2) Click *Next*.

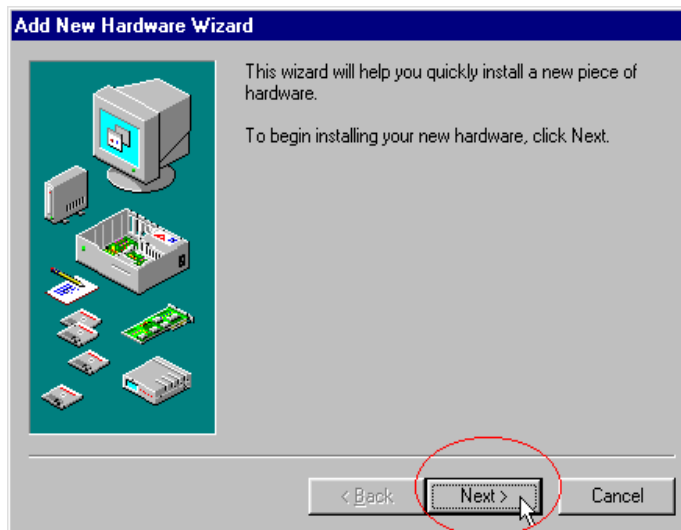

(3) Select *Yes [Recommended]* and click *Next*.



(4) Click *Next*.

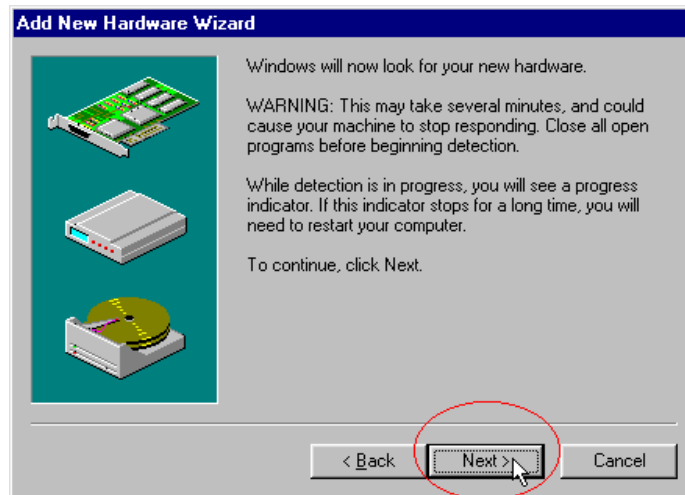

(5) Windows will take several minutes to detect the new hardware. When the progress is finished, click *Details* to check the new hardware.

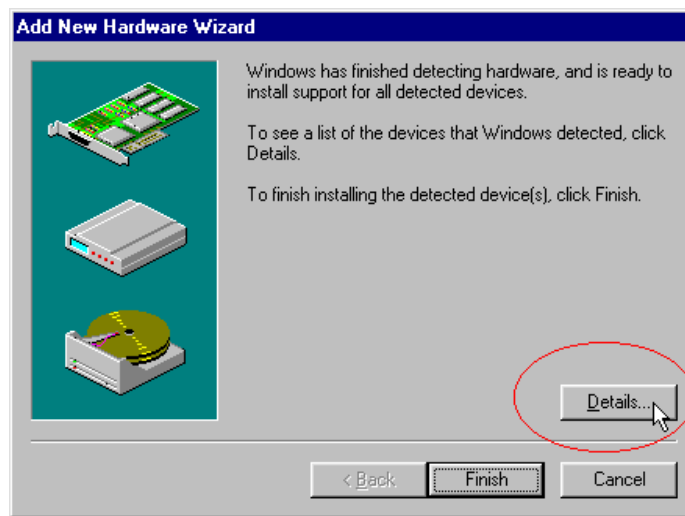

(6) Check the Windows detected the *Communication Port* and click *Finish*.

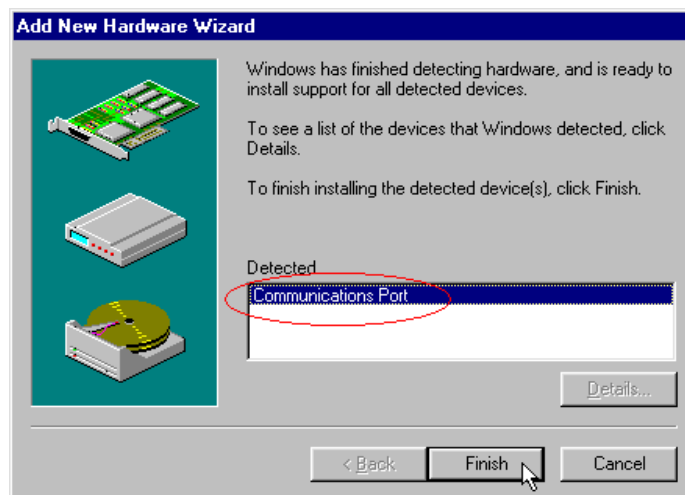

(7) Please go to the *Control Panel* and double-click on the *Modems* icon.

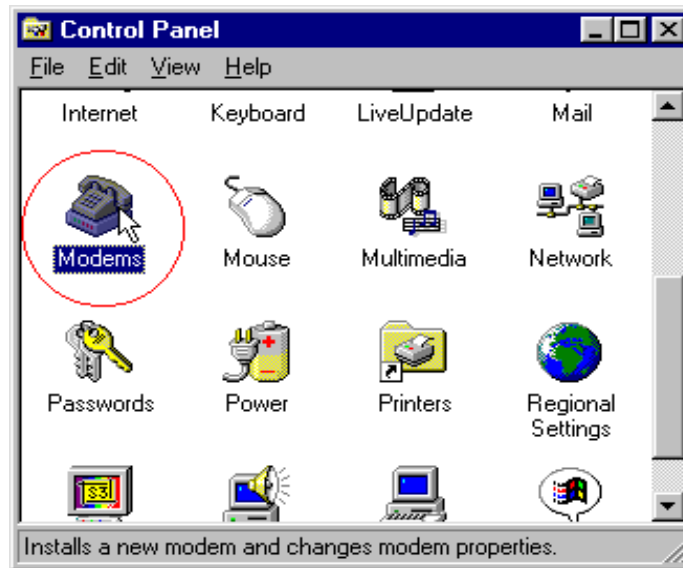

(8) Select *Don't detect my modem; I will select it from a list* and click *Next*.

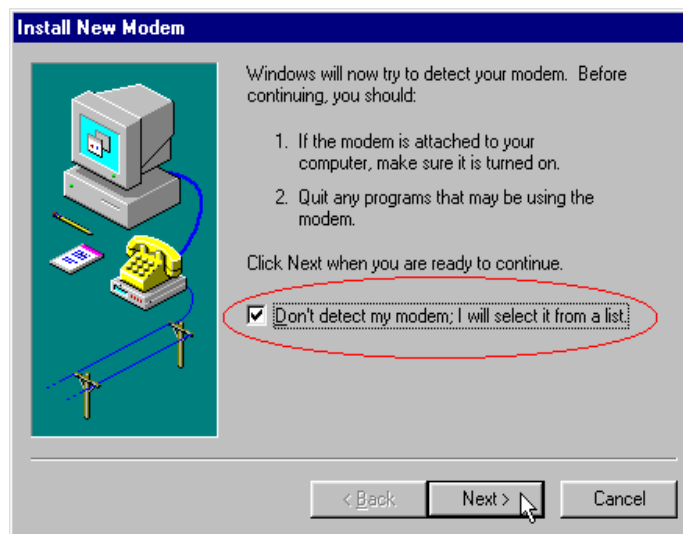

(9) Select *Have Disk*.

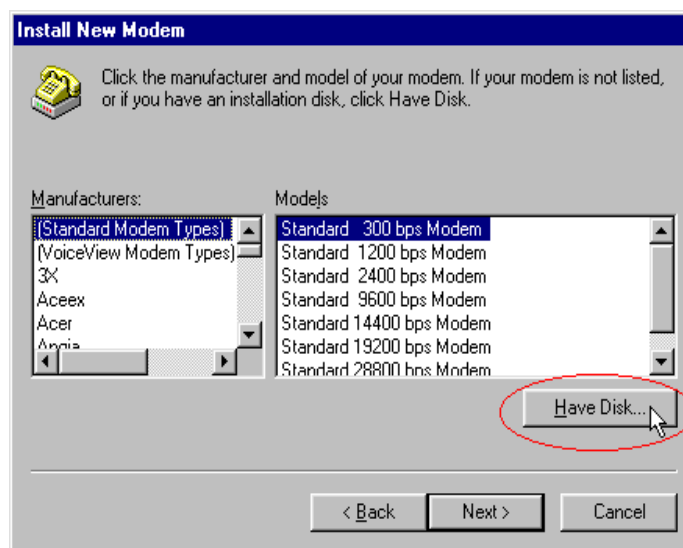

(10) Use **Browse** to select or type in the drive letter of floppy or CD-ROM (example: **A:\** or **D:\**) in the box, then click **OK**.

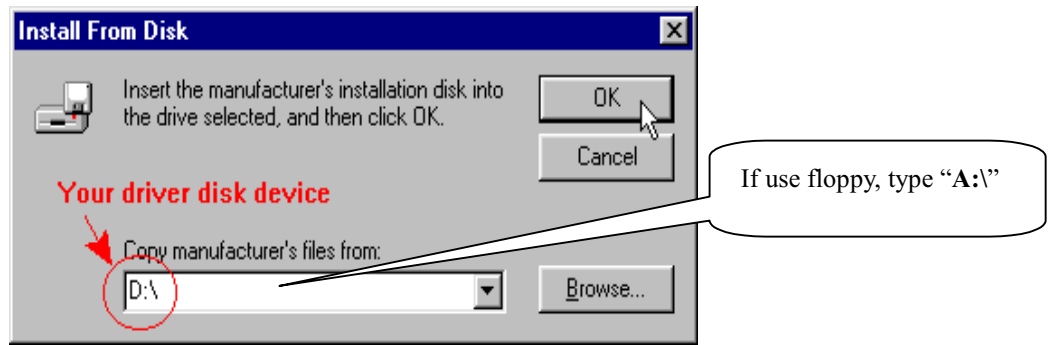

(11) Select Manufacturer: **Rockwell RSS** and Models: **Rockwell Internal V.90 K56 Voice Modem**, then click **Next**.

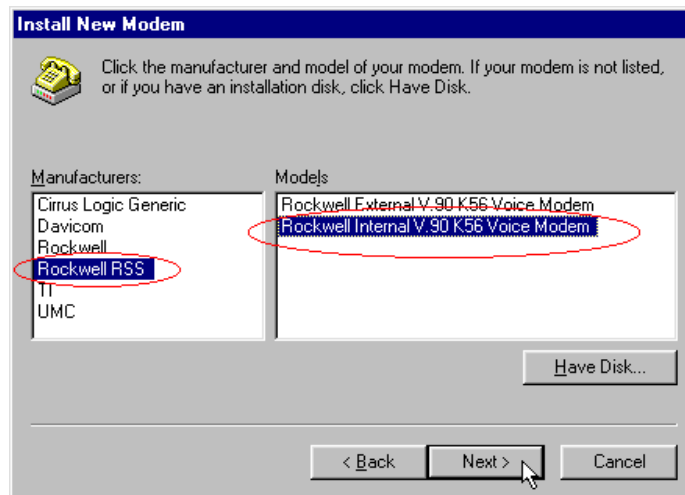

(12) Select the **Communication Port** depending on your modem and click **Next**.

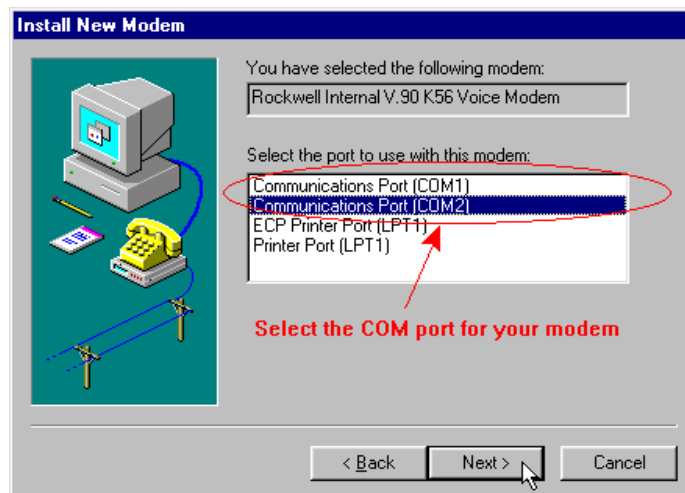



(13) If you use **Windows 95B(OSR2)/98**, the windows will detect the *Wave Device for Voice Modem*, please click *Next*. If you use **Windows 95A**, please go to **step(15)**.



(14) Windows will find *Rockwell Voice Modem Serial Wave Device* and click *Finish*. (If in **Windows 98**, please click *Next > Next > Finish*, then go to **step(16)**.)



(15) The Windows will show: *Your modem has been set up successfully*, then click *Finish*.

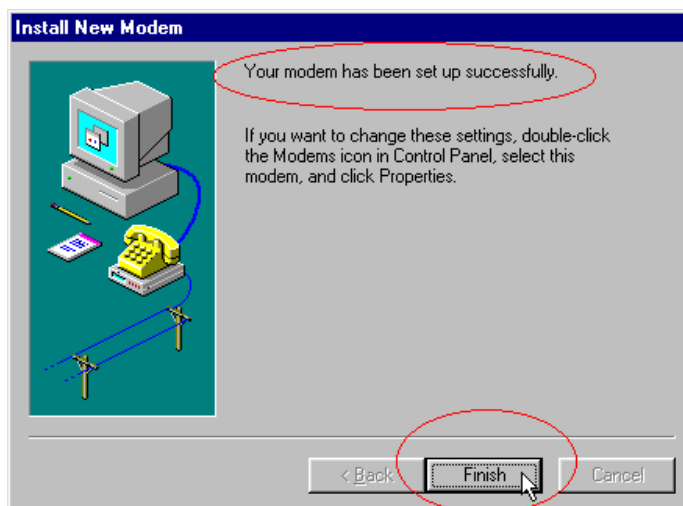

(16) You will see the *Rockwell Internal V.90 K56 Voice Modem* in the list and click *OK*.

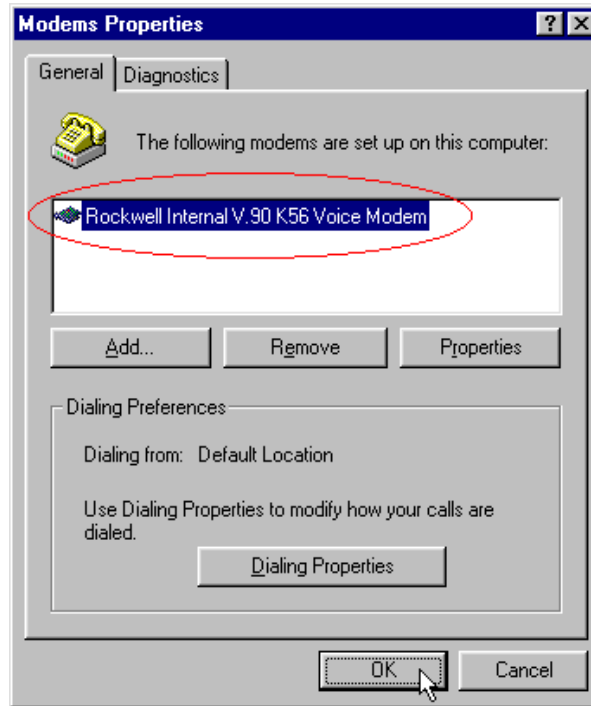

When Installation is complete, please proceed to setup dial-up networking and another communication software.

### 3.3. Modem Diagnostic in Windows 95/98

(1) Please go to *Start > Settings > Control Panel* and double-click on the *Modems* icon.



(2) Test the modem by clicking on the *Diagnostics* tab.

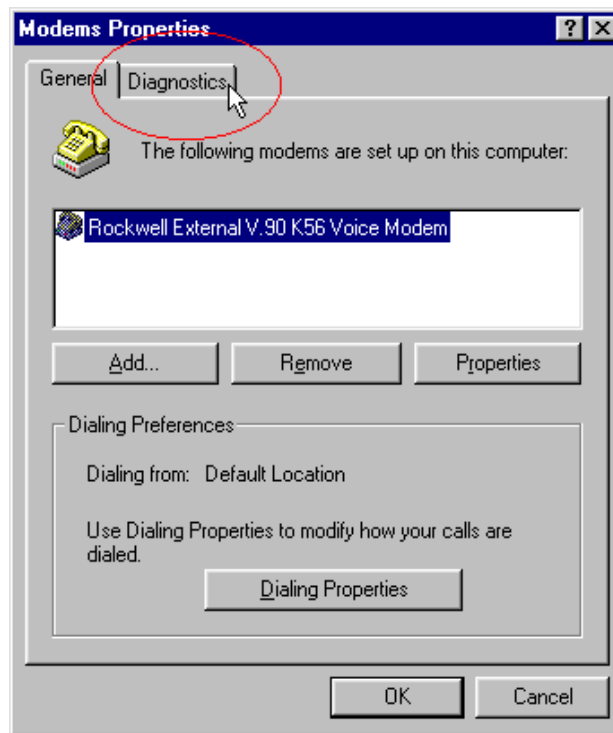

(3) Click on COM port ( example: *COM2 or COM3* ) that the modem is setting, then click on the *More Information* button.

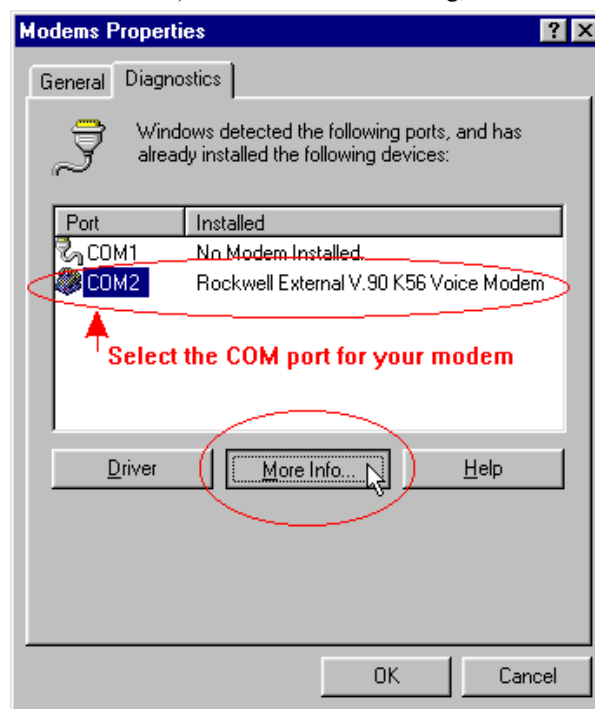

(4) If, after communicating with the modem, the AT-Command screen appears and response **OK**, that means the modem is working properly.

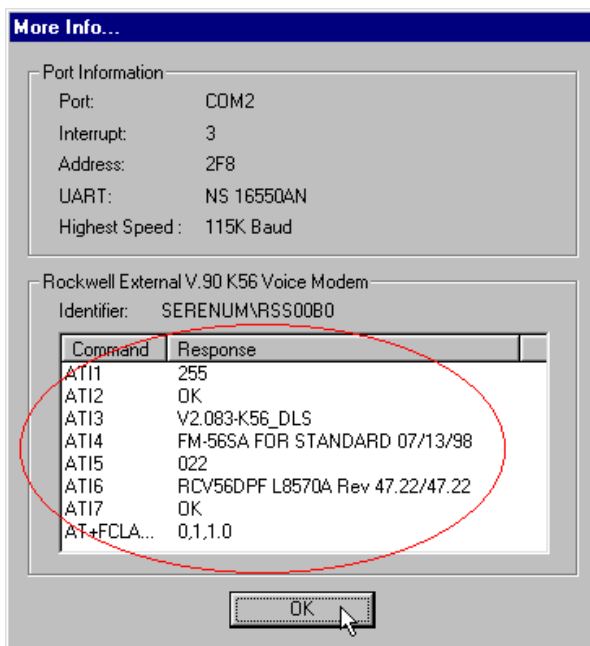

### 3.4 Installing Modem Drivers in Windows NT4.0

**Note:** If your modem is internal, we suggest setting the modem jumpers on *Non Plug and Play* mode (see page 7), because it is simpler to install than *Plug and Play* mode in Windows NT4.0.

(1) Please go to *Start > Settings > Control Panel*.

- \* If your modem is **Internal** modem, please double-click on the **Ports** icon.
- \* If your modem is **External** modem, please go to **step(5)**.



(2) Click on the **Add** button.

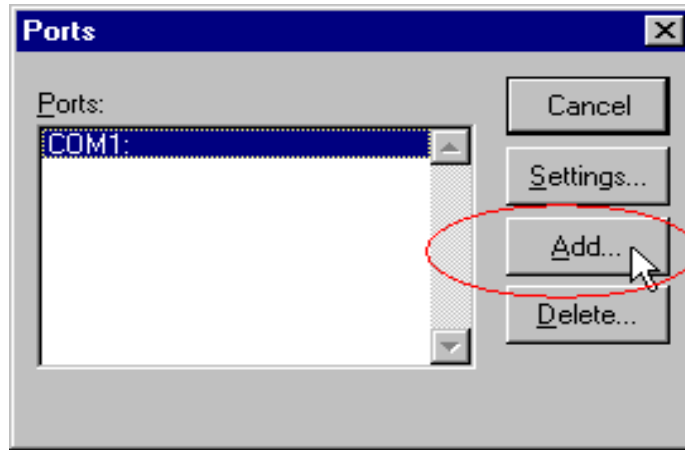

(3) Setup COM port, I/O port and IRQ for your internal modem and click **OK**. If you set modem in COM 2 (as example), please disable the **Serial Port 2** in the BIOS of the motherboard.

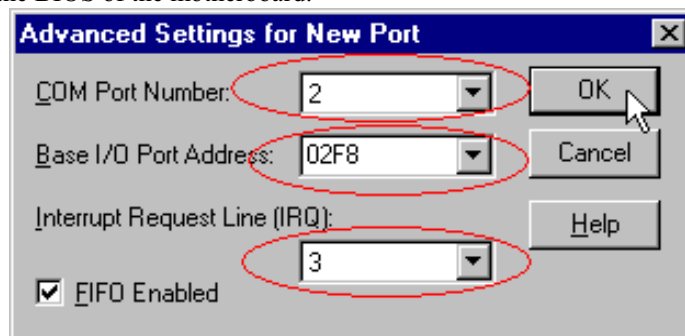

(4) Click on the **Restart Now** button to restart your Computer.

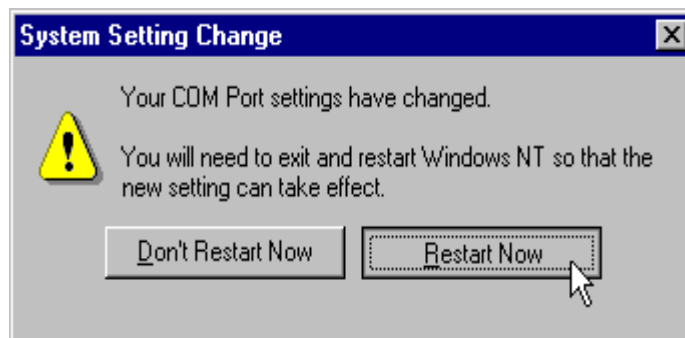

(5) Please go to **Start > Settings > Control Panel** and double-click on the **Modems** icon.

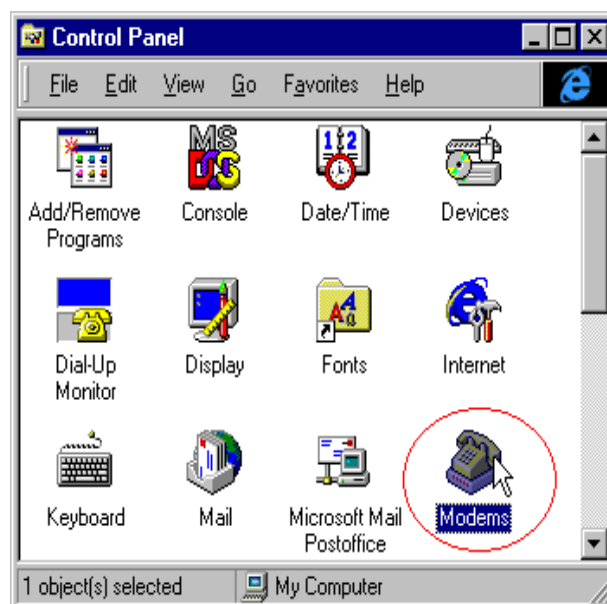

(6) Select **Don't detect my modem; I will select it from a list** and click **Next**.

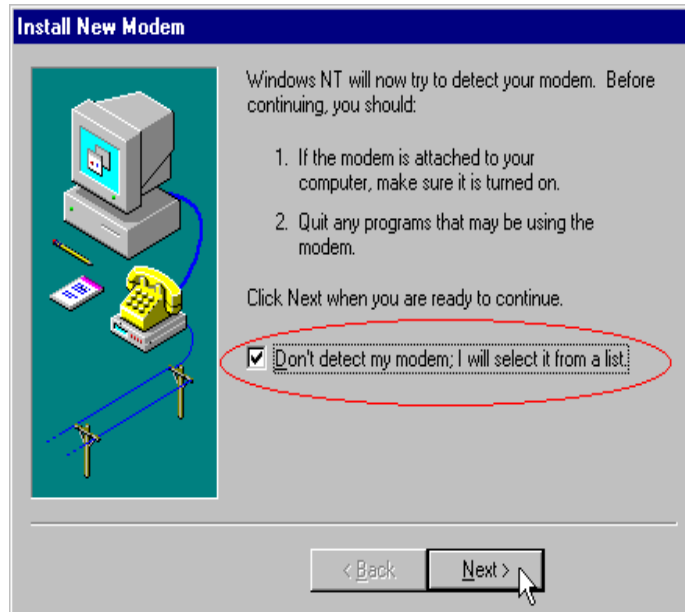

(7) Click on the **Have Disk** button.

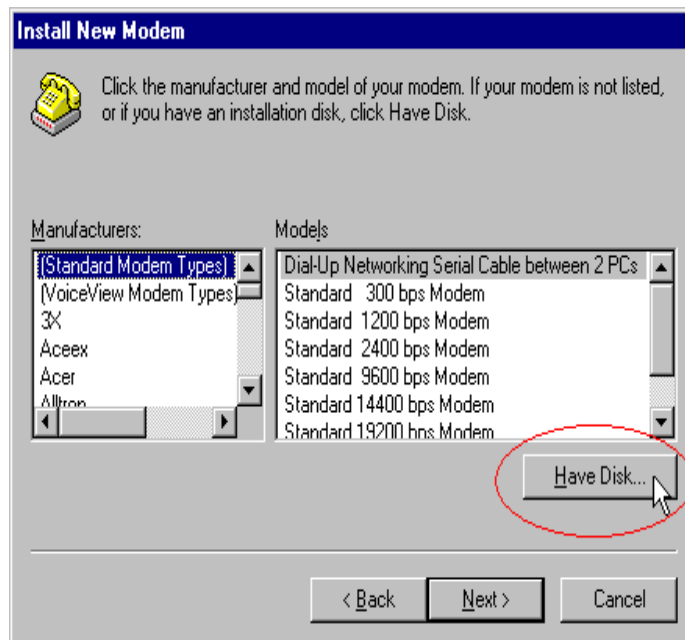

(8) Key in or use **Browse** to select or type in the driver letter of floppy or CD-ROM drive (**A:\** or **D:\**) and click **OK**.

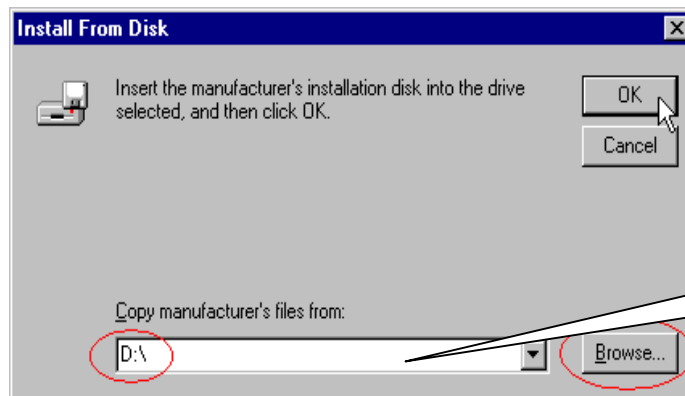

(9) Select **Manufacture: Rockwell RSS** and **Models: Rockwell External (or Internal) V.90 K56 Voice Modem** and **Next**.

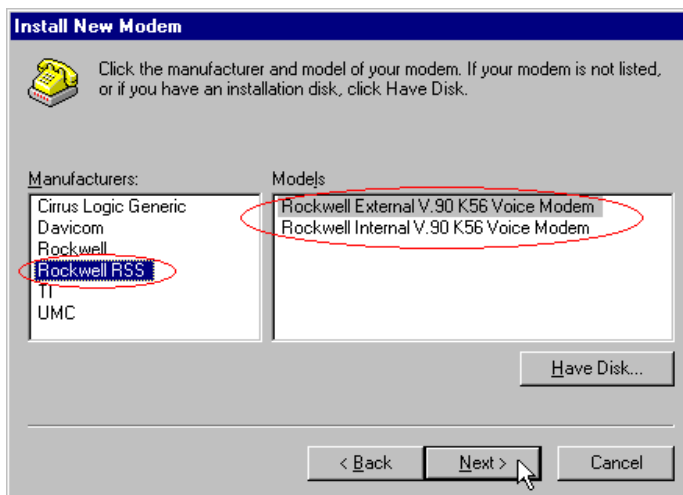

(10) Select COM port depending on your modem and click **Next**.

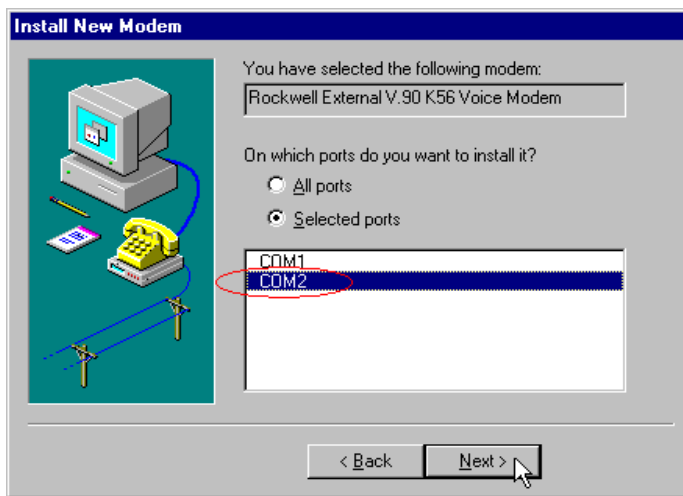

(11) Click on the **Finish** button.

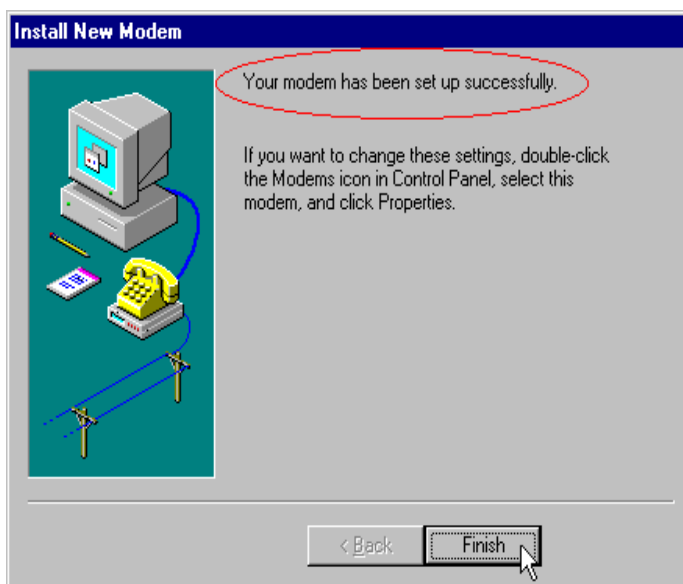

(12) You can see the modem: **Rockwell External (or Internal) V.90 K56 Voice Modem** in the list and click **Close**.

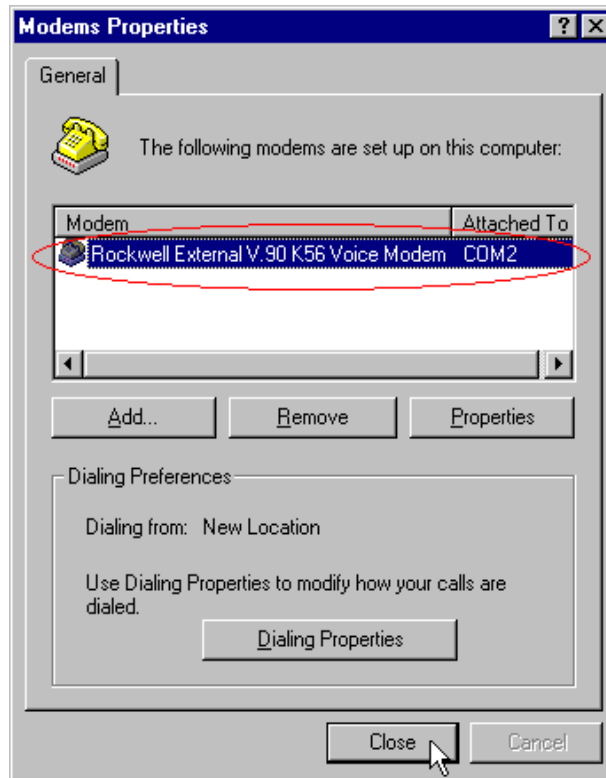

(13) Click **Yes** to configure the **Dial-up Networking**.

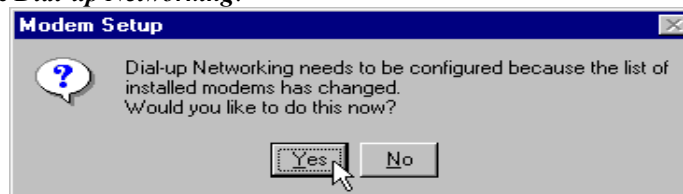

(14) Click on the **Add** button.

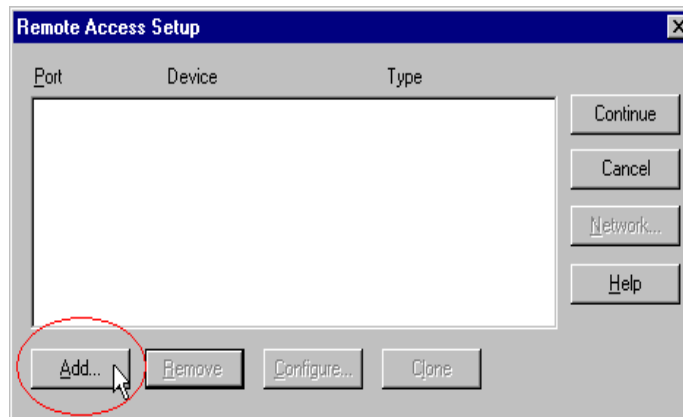

(15) Select **Rockwell External (or Internal) V.90 K56 Voice Modem** and click **OK**.

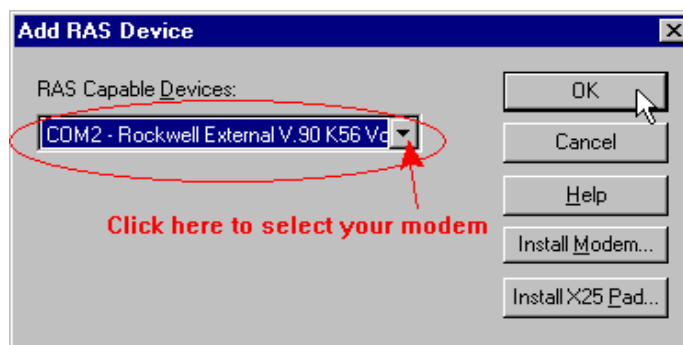



(16) Click on the *Configure* button.

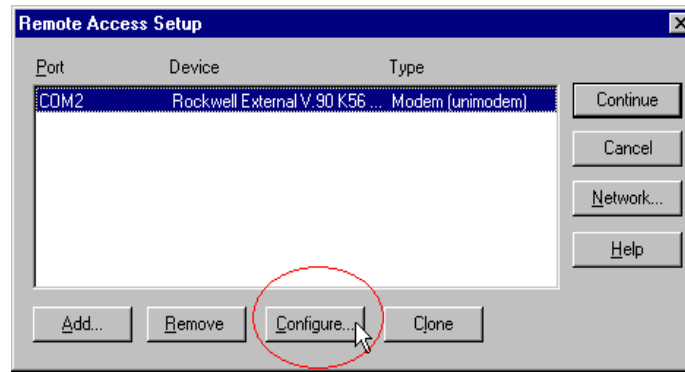

(17) Select *Dial out only* or other options and click *OK*.

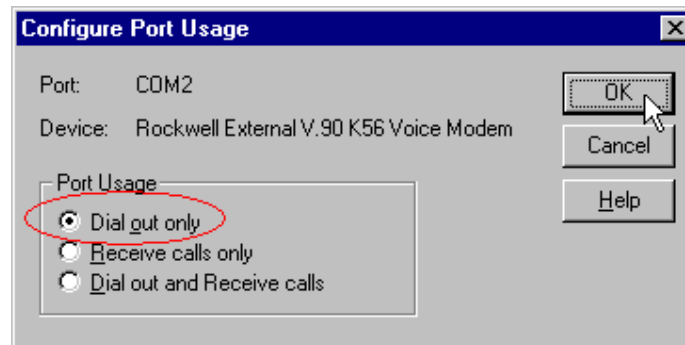

(18) Click on the *Network* button.

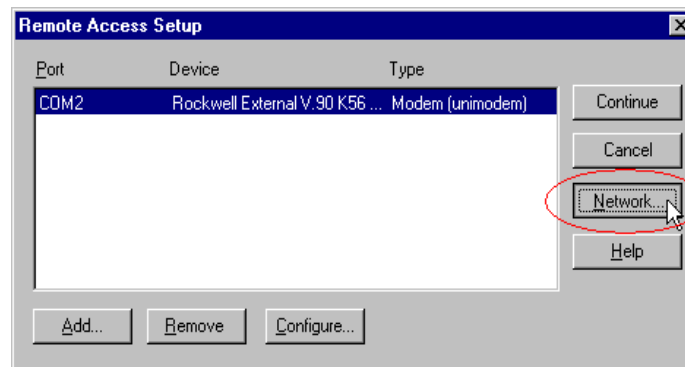

(19) Select *TCP/IP* and click *OK*.

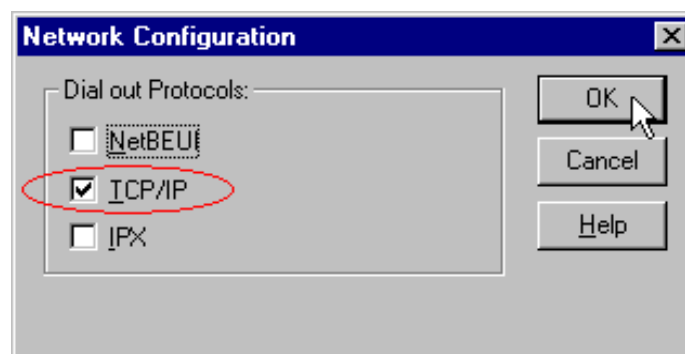

(20) Click on the *Continue* button.

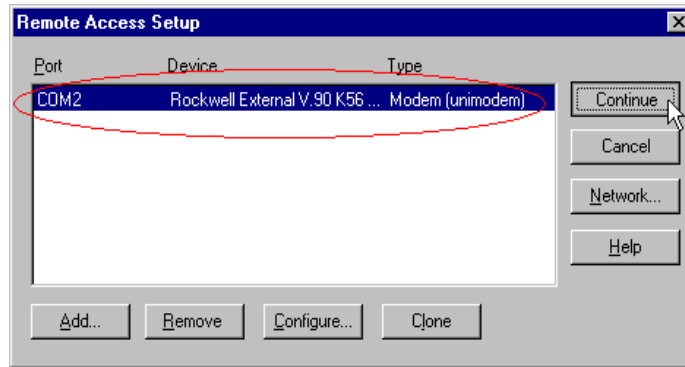

(21) Click on the *Yes* button to restart your computer.

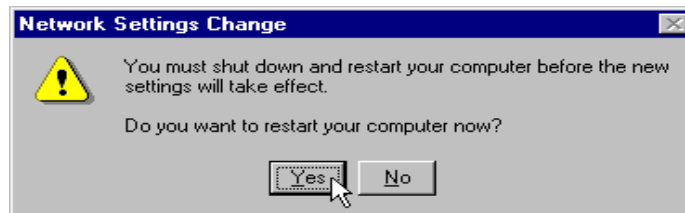

### 3.5. Setup Dial-Up Networking in Windows NT4.0

(1) Please go to *My Computer > Dial-Up Networking*.

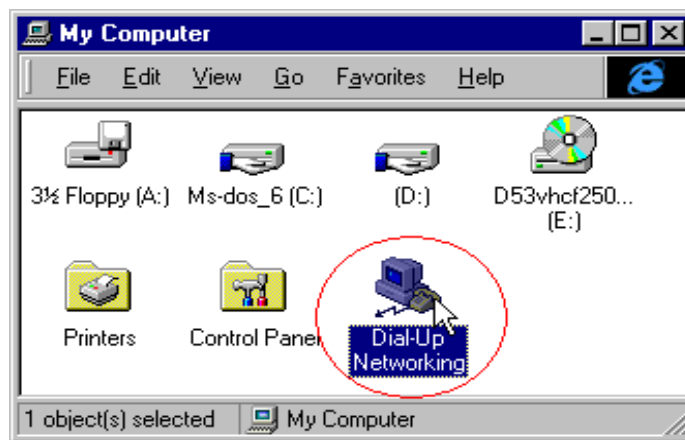

(2) If you never setup the phonebook before, the window will show the message: *The phonebook is empty*, then click *OK*.

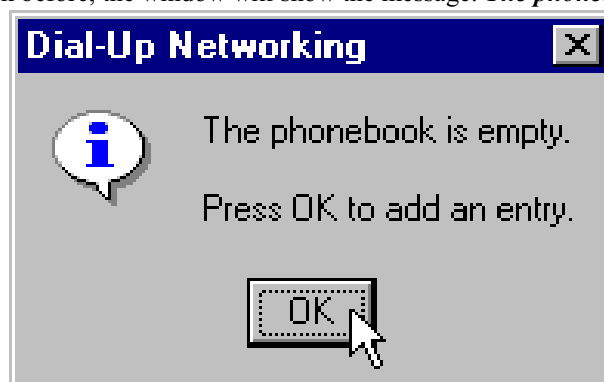

(3) Type in any name you like and click *Next*.

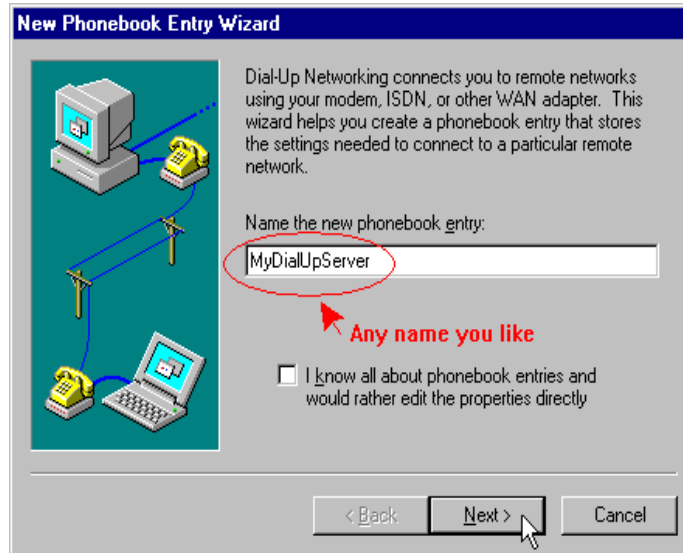

(4) Select *The non-Windows NT server I am calling expects me to...*, then click *Next*.

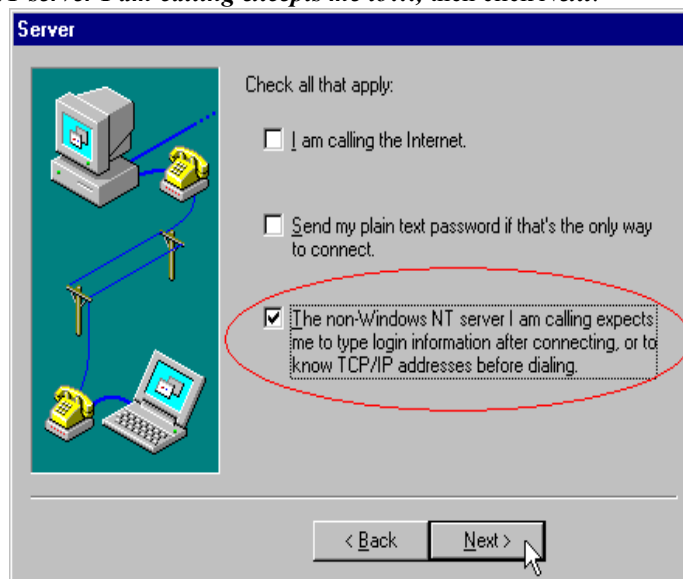

(5) Type in the *Phone number* to your Internet Service Provider, then click *Next*.

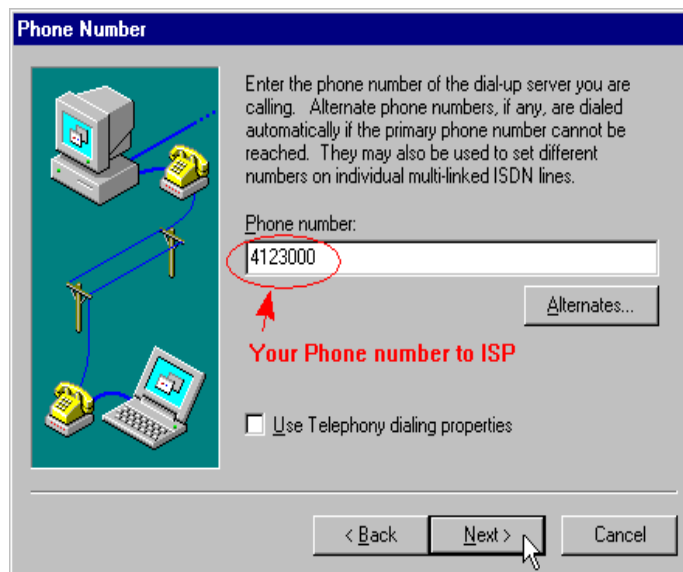

(6) Select *Point-to-Point Protocol (PPP)* and click *Next*.

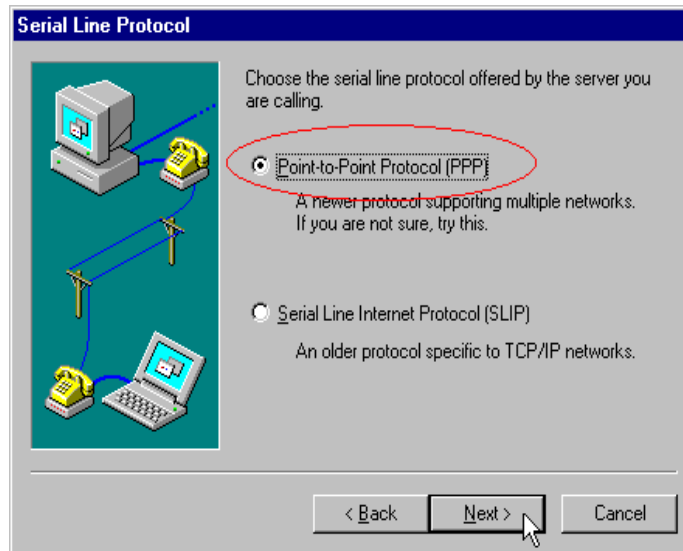

(7) Select *None* or *Use a terminal window* depending on your ISP and click *Next*.

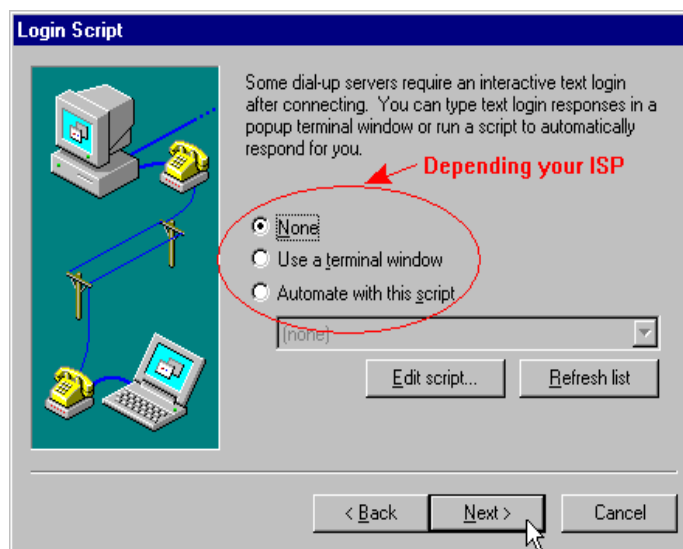

(8) If you have fixed IP address, please type in your IP; or you can ignore it and click *Next*.

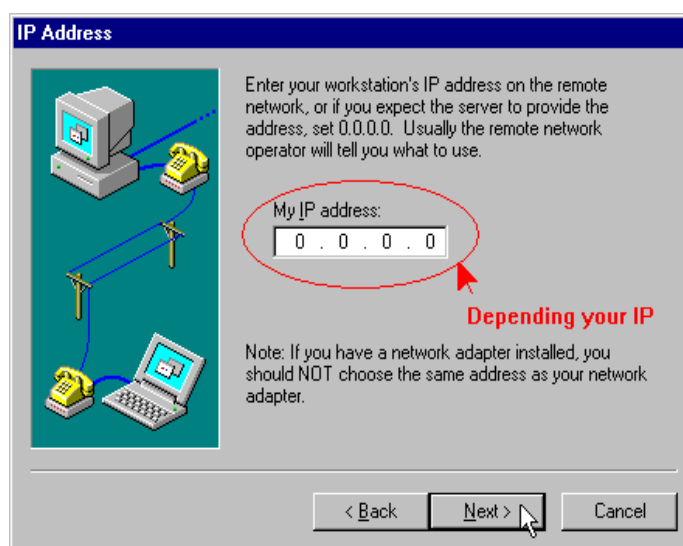

(9) Type in DNS server for your ISP. If your ISP support dynamic DNS server, you can ignore it and click *Next*.

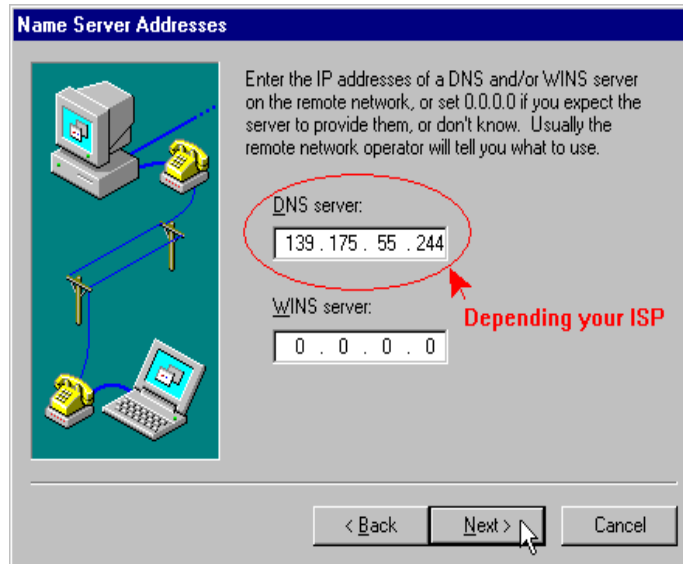

(10) Click *Finish*.

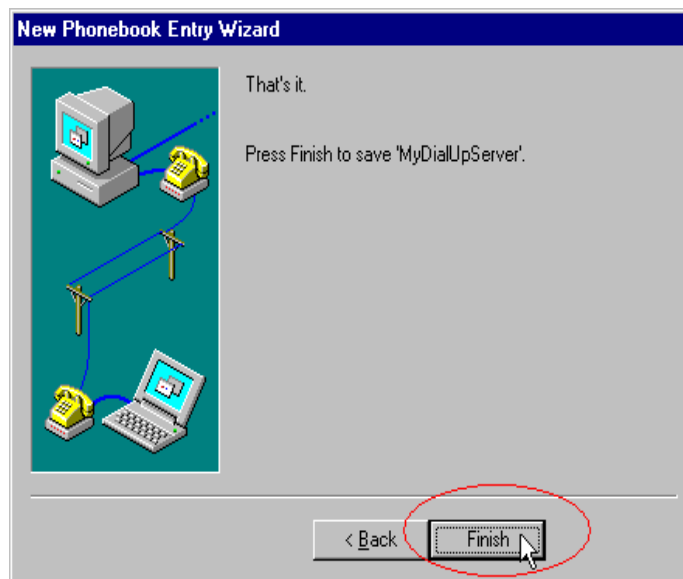

(11) Click on the *More* button.

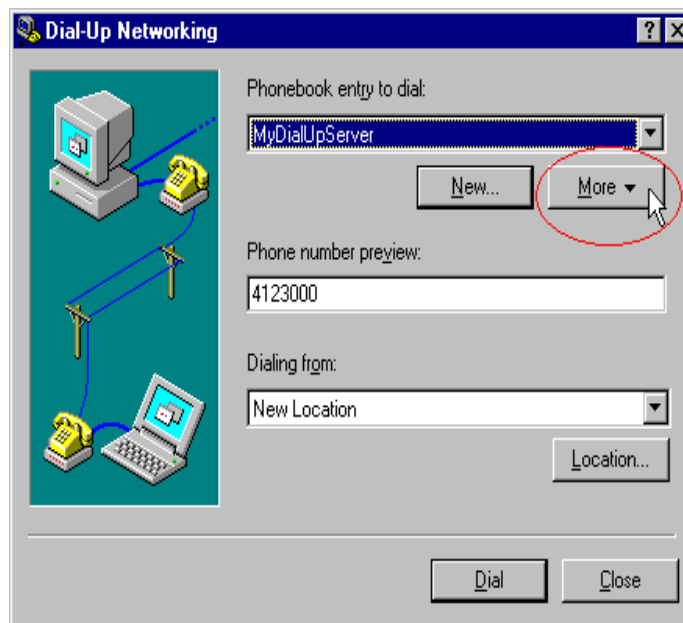

(12) Select *Edit entry and modem properties*.

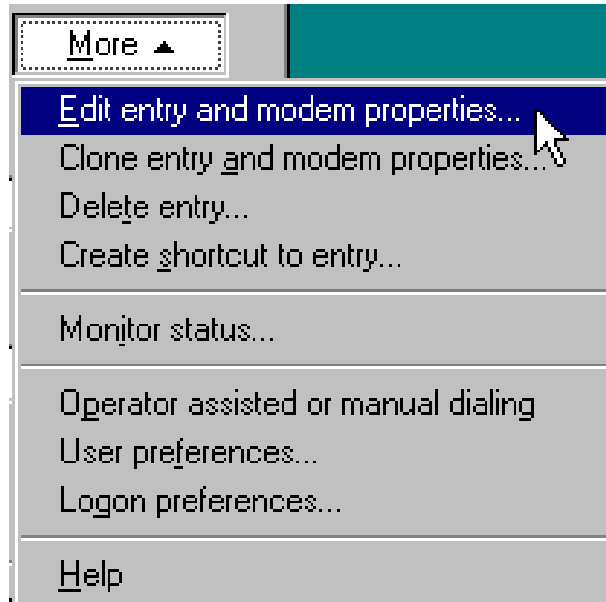

(13) Select your modem: *Rockwell External (or Internal) V.90 K56 Voice Modem* and click on the *Configure* button.

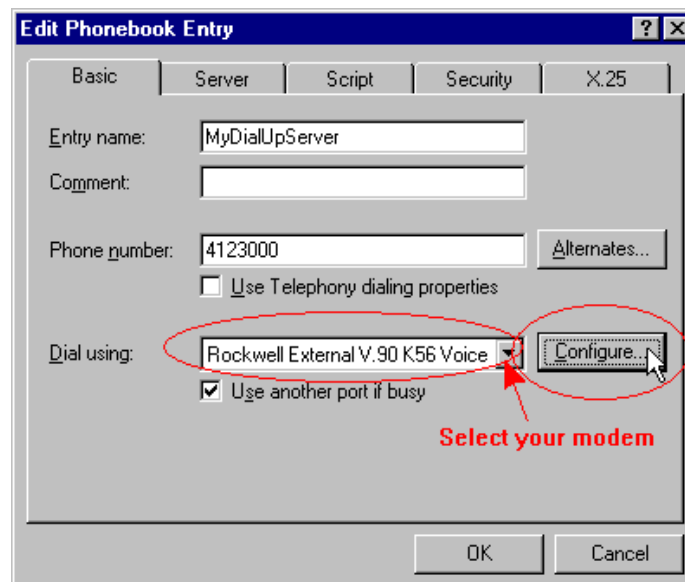

(14) Select *initial speed: 115200* and select all the options for *Hardware Features*, then click *OK*.

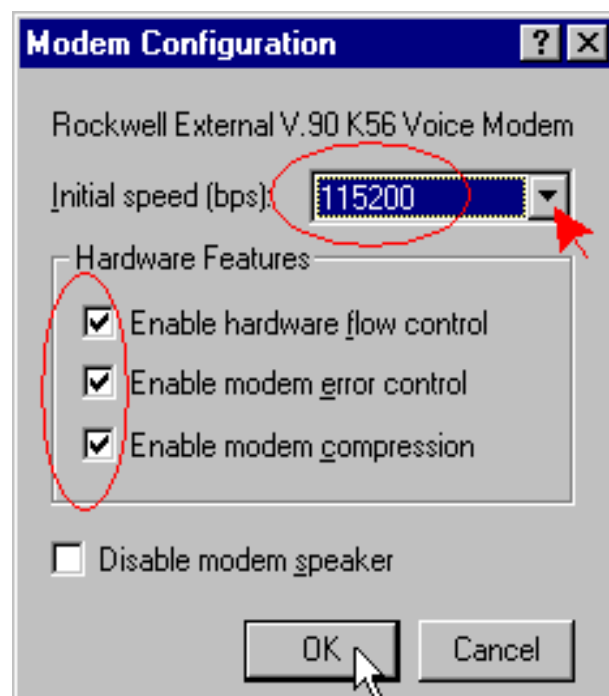

(15) Select *TCP/IP*, *Enable software compression* and *Enable PPP LCP extensions*, then click *OK*.

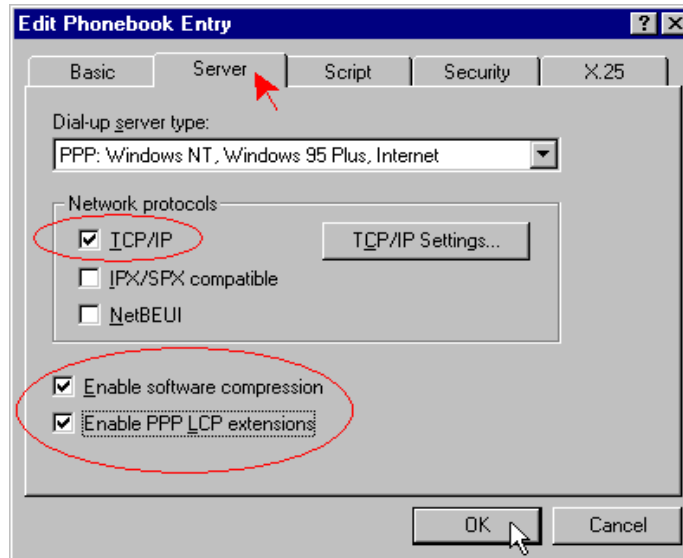

(16) Select *Accept any authentication including clear text*, then click *OK*.

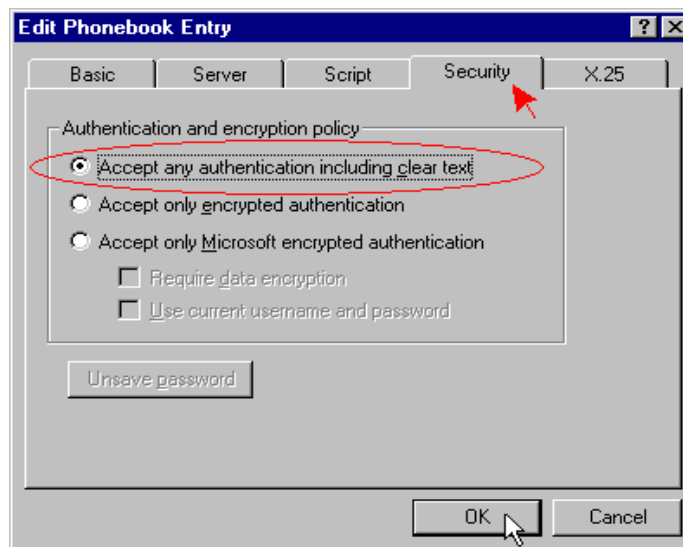

(17) Click *Dial*.

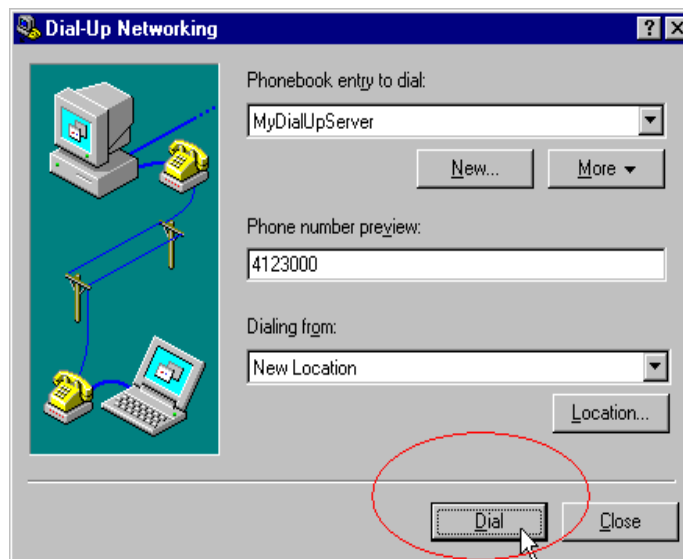

(18) Type in your *User name* and *Password*, then click *OK*.



Then the modem will dial out and connect to the internet.



## Chapter 4 Trouble Shooting

### If you are fails to install your modem

#### Internal modem :

- Make sure the COM port and IRQ Setting are correctly, and it doesn't conflict with another board installed in your computer.
- If your modem is using COM3 or COM4, Windows might not recognize it, and you will get a message such as " Modem does not exist". The reason is that most PC don't allow COM ports to share the same IRQ line, thus if your mouse is using COM 1, but your modem is using COM 3, the conflict might arise, unless your reconfigured modem to another IRQ line (For example IRQ 5), also you need to tell windows reassigned IRQ-line to take effect.

Standard COM Port	IRQ	Address
COM1	4	3F8
COM2	3	2F8
COM3	4	3E8
COM4	3	2E8

#### External modem:

- Be sure your RS-232 Cable and Power adapter are connected properly between modem and your PC.
- Make sure AC outlet and modem power-switch is set to on-position.

If above are correctly and the modem LED are not lit, Please contact the dealer or distributor.

### Modem won't execute AT commands

- The COM port of your software or DTE perhaps set up incorrectly, for example, your software may be configured on COM 1, but your modem may be configured as another COM port (such as COM 2).
- Check RS-232 cable is connected properly, verify modem LED " DTR" is ON, otherwise check above procedure again.
- Be sure you are sending commands at an acceptable baud rate, 300, 1200, 2 400, 4800, 9600, 19200, 38400, 57600 or 115200bps.
- Make sure you are using an acceptable character format, for example : 8 data bits, no parity, one stop bit.
- Type AT&F [ENTER], reset original factory default and try execute AT commands again.

### Modem will not dial-out

- Check your phone cable connected properly into "LINE" jack.
- sending dial tone incorrectly, disable X4.

### Modem will not answer an incoming call

- Check your phone cable connected properly into "LINE" jack.
- By connect a Telephone to the " PHONE" jack. The attached telephone will ring if you try calling from another telephone line.
- Configured the modem to Auto-answer modem.  
Type AT S0=n where n is the number of incoming rings and check light "AA" is on.( External modem)

### No connection after modem dial out

- Remote modem may be not setting to answer mode, if you aren't hearing a high-pitch tone when remote modem answering.
- Perhaps poor-quality or noise telephone lines try another call.

### Data error when modem connection

- Make sure your software data format is match to remote side (for example : 8,N, 1).
- Make sure the modem flow control method is matched to communication software.
- Try another call may be poor quality or noise telephone lines.

### Fax and voice problems

- Be sure the Data Communication is installed and worked properly, otherwise check the mentioned procedure carefully and consult the Fax/Voice manual step by step.

## ***Chapter 5 FCC Requirements***

This equipment complies with Part 68 or the FCC Rules. On the bottom of this equipment is a label that contains, among other information, the FCC Registration Number and Ringer Equivalence Number (REN) for this equipment. IF REQUESTED, THIS INFORMATION MUST BE GIVEN TO THE TELEPHONE COMPANY.

The REN IS useful to determine the quantity of devices you may connect to your telephone line and still have all of those devices ring when your telephone number is called In most. But not all areas the sum of the REN's of all devices connected to one line should not exceed five (5.0). To be certain of the number of devices you may connect to your line, as determined by the REN. You should contact your local telephone company to determine the maximum REN for your calling area. If your telephone equipment causes harm to the telephone network. The telephone company may discontinue your service temporarily. If possible, they will notify you in advance. But if advance notice isn't practical, you will be notified as soon as possible. You will be informed of your right to file a complaint with the FCC.

Your telephone company may changes in it's facilities, equipment, operations or procedures that could affect the proper functioning of your equipment. If they do, you will be notified in advance to give you an opportunity to maintain uninterrupted telephone service.

If you experience trouble with this telephone equipment, please contact the following address and phone number for information on obtaining service or repairs. The telephone company may ask that your disconnect this equipment from the network until the problem has been corrected or until you are sure that the equipment is not malfunctioning. This equipment may not be used on coin service provide by the telephone company. Connection to party lines is subject to statetariffs.

# Federal Communications Commission Radio Frequency Interference Statement.

Note: This equipment has been tested and found to comply with the limits for a class B digital device pursuant to Part 15 of the FCC Rules. These limits are designed to provide reasonable protection against harmful interference when the equipment is operated in a residential installation. This equipment generates, uses, and can radiate radio frequency energy and if not installed and used in accordance with the instruction manual may cause harmful interference to radio communications. However, there is no guarantee that interference will not occur in a particular installation. If the equipment does cause harmful interference to radio or television reception, which can be determined by tuning the equipment off and on, the user is encouraged to try to correct the interference by one or more of the following measures:

- Reorient or relocate the receiving antenna.
- Increase the separation between the equipment and receiver.
- Connect the equipment into an outlet on a circuit different from that to which the receiver is connected. Consult the dealer or an experienced radio TV technician for help.

Notices:

- (1) The changes or modifications not expressly approved by the party responsible for compliance could void the user's authority to operate the equipment.
- (2) Shielded interface cables and AC power cord if any must be used in order to comply with the emission limits.

## APPENDIX 1: How to Change the V.90/K56Flex Protocol for Rockwell 56K ACF Modem

Note: This upgrade program is **only for Rockwell 56k ACF modem** (1MB flash ROM).

1. Please see the user manual to install the Modem Driver first and check your modem is OK.
2. Please select one file from driver floppy: (Depending on the protocol of your ISP and modem)

"\*\*\*v90e.exe": for **V.90** protocol and **External** modem.

"\*\*\*v90i.exe": for **V.90** protocol and **Internal** modem.

"\*\*\*k56e.exe": for **K56Flex** protocol and **External** modem.

"\*\*\*k56i.exe": for **K56Flex** protocol and **Internal** modem.

P.S. "\*\*\*\*" is the first three letters for your country.

Double-click on the file (upgrade program) and see the procedure as following:

- (1) The program will find your modem and click on the **Load Now** button. (If the program can not find your modem, please check your upgrade program is correct and the modem is working fine. Then run the upgrade program again)

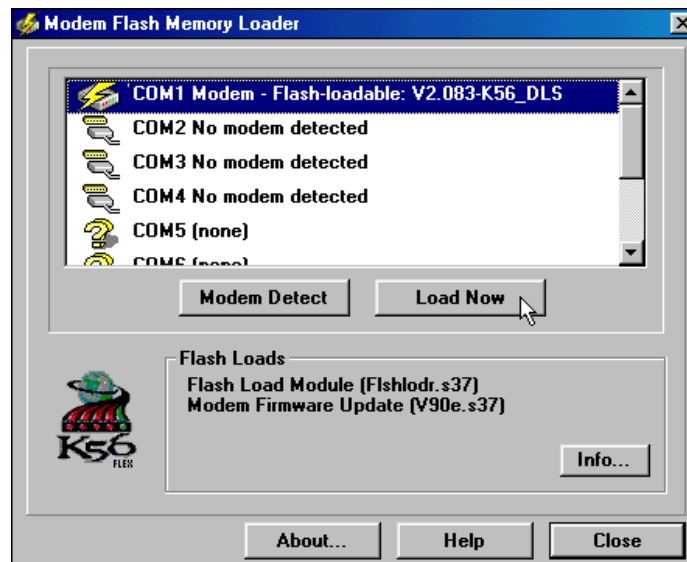

(2) Check the upgrade program is correct and click **OK**.

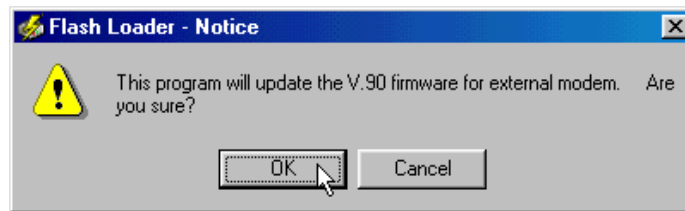

(3) When the **Load Progress** display **100%**, click on the **Close** button.

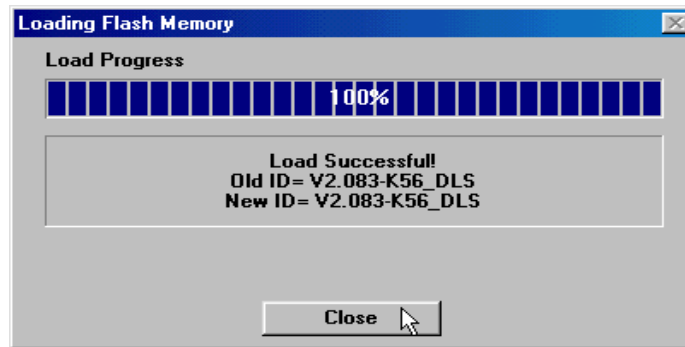

(4) Click on the **Close** button to close the upgrade Window.

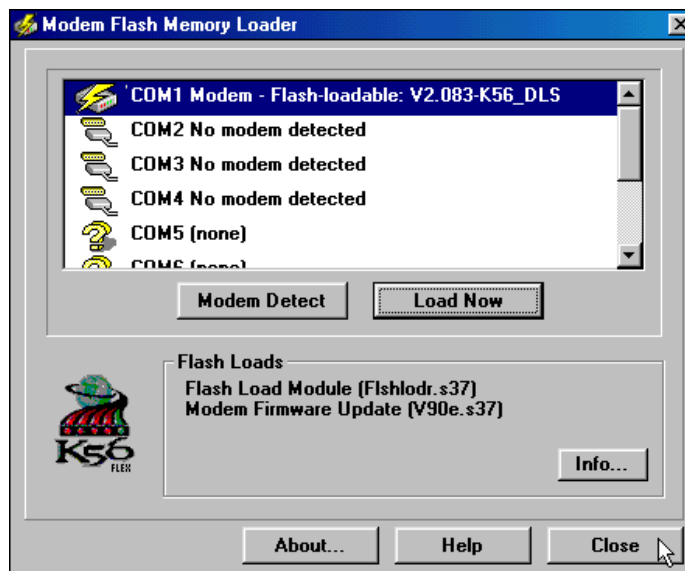

3. If you can't check AT command after programming, please restart your modem and computer to check again. If the modem is no response, please contact your local dealer for help.