

Concerning Compact Discs



Only compact discs bearing this mark can be used with this unit.

However, continued use of irregular shaped CDs can damage the unit.



How to remove a disc from its case

How to store the disc in its case



How to hold a disc



If the surface is dirty

Wipe it with a damp cloth and then wipe dry.

Wipe from the center toward the outer circumference.



Handling precautions

- If you are taking the CD from a cold to a warm environment, moisture may form on the CD. Wipe this off with a soft, dry, lint-free cloth before using the CD.
- Do not write on the label side with a ball-point pen or other writing instrument.
- Do not use record cleaning sprays, benzene, thinner, static electricity prevention liquids or any other solvent.
- Do not attach labels or stickers to CDs. (Do not use CDs with exposed adhesive from tape or left over peeled off stickers.)

- Do not use scratch-proof protectors etc.

Storage precautions

Be sure to store CDs in their cases to protect them from dust, scratches, and warping.

Do not place or store CDs in the following places

- Locations exposed to direct sunlight
- Humid or dusty locations
- Locations directly exposed to a heat vent or heating appliance
- In the glove compartment or on the rear deck of an automobile

Portable CD player

Panasonic

Dear Customer

Thank you for purchasing this product. For optimum performance and safety, please read these instructions carefully.

Operating Instructions

Model No.
SL-SX390

The model number and serial number of this product can be found on either the back or the bottom of the unit.

Please note them in the space provided below and keep for future reference.

MODEL NUMBER SL-SX390

SERIAL NUMBER _____



Supplied Accessories

Check the packing carton for these accessories.

Wired remote control (N2QCBD00023) 1

For U.S.A.

Stereo headphones (RFEV716P-SS) 1

For Canada

Stereo earphones (L0BAB000124) 1

Use numbers indicated in parentheses when asking for replacement parts.

(Only for U.S.A.) To order accessories contact 1-800-332-5368 or web site

(<http://www.panasonic.com>).

Before connecting, operating or adjusting this product, please read these instructions completely. Please keep this manual for future reference.



Panasonic Consumer Electronics Company

Division of Matsushita Electric Corporation of America

One Panasonic Way Secaucus, New Jersey 07094

<http://www.panasonic.com>

Panasonic Sales Company, Division of Matsushita Electric of Puerto Rico, Inc. ("PSC")
Ave. 85 de Infiltración, Km. 9.5 San Gabriel Industrial Park, Carolina, Puerto Rico 00985

Panasonic Canada Inc.

5770 Ambler Drive, Mississauga, Ontario L4W 2T8

www.panasonic.ca

© 2001 Matsushita Electric Industrial Co., Ltd.

RQT6190-1P F1101KN3111

Printed in Japan

IMPORTANT SAFETY INSTRUCTIONS

Read these operating instructions carefully before using the unit. Follow the safety instructions on the unit and the safety precautions listed below. Keep these operating instructions handy for future reference.

Safety

- 1. Power source**—Connect the unit to a power source of the type described in these instructions or as marked on the unit.
- 2. Polarization**—The unit is equipped with a polarized power plug where one blade is wider than the other. This safety feature ensures that the plug fits into your household AC outlet only one way. If the plug doesn't fit one way, try reversing it. If the plug still doesn't fit, contact an electrician to replace the obsolete outlet. Do not attempt to defeat the safety purpose of the plug.
- 3. Power cord protection**—Route the AC power supply cord so that it will not be walked on or pinched by items placed on or against it. Never take hold of the plug or cord with wet hands. Always grasp the plug body firmly when connecting and disconnecting it.
- 4. Overloading**—When connecting the AC power supply cord, be careful not to overload the household AC outlet, extension cord, or outlet from any other device as this can result in fire or electric shock.
- 5. Nonuse periods**—Turn the unit off when it is not in use. Unplug the unit from the household AC outlet if it is not to be used for a long time. Unplug the unit during lightning storms. Leaving the unit connected to a household AC outlet for extended periods can cause battery fluid leakage.
- 6. Attachments and accessories**—Use only the attachments and accessories recommended in these operating instructions.

Installation

Placement

- 1. Foreign material**—Ensure objects and liquids do not get into the unit. Avoid exposing the unit to excessive smoke, dust, mechanical vibration, and shock.
- 2. Magnetism**—Situate the unit away from equipment and devices that generate strong magnetic fields.
- 3. Stacking**—Do not place anything on top of this unit.
- 4. Wall and ceiling mounting**—Do not mount the unit on walls or ceilings unless specified in the instructions.

Environment

- 1. Water and moisture**—Do not use the unit near water, such as near a bathtub or swimming pool. Avoid damp basements.
- 2. Heat**—Situate the unit away from heat sources, such as radiators. Do not leave it in an automobile exposed to direct sunlight with the doors and windows closed as this may deform the cabinet. Do not situate where temperatures fall below 5 °C (41 °F) or rise above 35 °C (95 °F).

Maintenance

(See page 7 for details.)

Unplug the unit from the household AC outlet before cleaning.

Clean with a damp cloth.

Do not use abrasive pads, scouring powders, or solvents.

Service

- 1. Damage requiring service**—The unit should be serviced by qualified service personnel if:
 - (a) The AC power supply cord or AC adaptor has been damaged; or
 - (b) Objects or liquids have gotten into the unit; or
 - (c) The unit has been exposed to rain; or
 - (d) The unit does not operate normally or exhibits a marked change in performance; or
 - (e) The unit has been dropped or the cabinet damaged.
- 2. Servicing**—Do not attempt to service the unit beyond that described in these operating instructions. Refer all other servicing to authorized servicing personnel.
- 3. Replacement parts**—When parts need replacing ensure the service uses parts specified by the manufacturer or parts that have the same characteristics as the original parts. Unauthorized substitutes may result in fire, electric shock, or other hazards.
- 4. Safety check**—After repairs or service, ask the service to perform safety checks to confirm that the unit is in proper working condition.



This manual was printed with soy based ink.

Power Supply Preparations

Refer to the specifications (page 8) for information on operating times when using dry cell batteries.

Using dry cell batteries (not included)

Insert two "LR6, AA, UM-3" alkaline batteries.

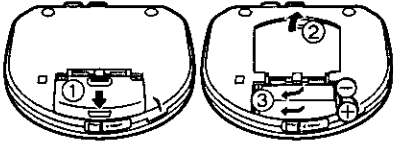

If the battery lid comes loose
Slide the lid back into place horizontally.

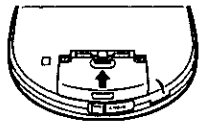

Removing batteries
Push up on the battery in the direction indicated by the arrow. Then lift it out.

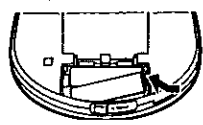

Note

The dry cell batteries should be changed when the unit is off.

Using rechargeable batteries (not included)

- If rechargeable batteries are to be used, rechargeable batteries manufactured by Panasonic are recommended.
- This unit cannot recharge batteries. The battery indicator will not function correctly when using rechargeable batteries.

Using the AC adaptor (not included)

Use only the recommended AC adaptor. Use of other AC adaptors can damage the unit.

For U.S.A.

To order the optional AC adaptor RP-AC46 contact 1-800-332-5368 or web site (<http://www.panasonic.com>).

For Canada

Be sure to obtain the optional AC adaptor RP-AC46. It is available through your Panasonic dealer.

Connect the AC adaptor.

DC IN jack (DC IN 4.5 V \ominus \oplus)

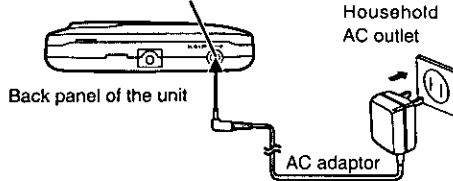

Conserving power

To save power when the unit is not to be used for a long time, unplug the AC adaptor from the household AC outlet. Reprogram tracks if necessary before use.

Note

Turn the unit off before connecting or disconnecting the AC adaptor.

If the unit malfunctions or freezes during use, disconnect the power source (the AC adaptor or batteries). Re-connect the power source and continue operation.

Battery indicator

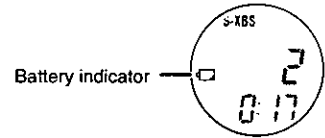

This indicator flashes when the batteries are almost out of power. Power is cut off completely a short while later. Replace batteries with new ones.

Note

The length of time the unit will continue to operate between when the battery indicator starts flashing and when the power is cut off differs depending on the type of batteries used.

Using the car adaptor (not included)

Use only the recommended car adaptor. Use of other car adaptors can damage the unit. Be sure to obtain the car adaptor (SH-CDC9) available as an optional accessory.

CAUTION:

Use only car adaptor, Model: SH-CDC9 manufactured by Matsushita Electric Industrial Co., Ltd.

Location of Controls

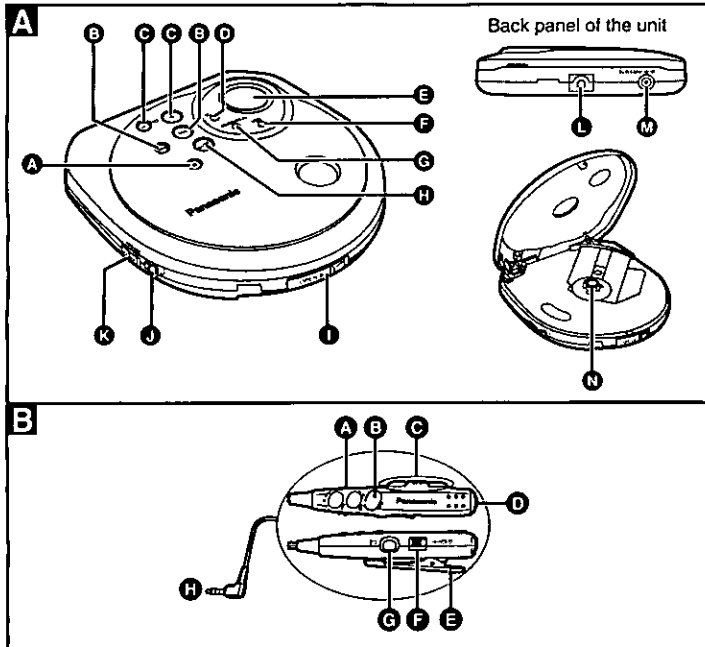

Portable CD Player **A**

- A** Stop/operation off button (■)
- B** Skip/search buttons (◀▶)
- C** Headphone volume control buttons (-, VOL, +)
- D** EQ button (EQ)
- E** Display
- F** Mode button (MODE)
- G** Memory/recall button (MEMORY/RECALL)
- H** Play/pause button (▶/||)
- I** Open switch (OPEN ▶)
- J** Headphone jack (📎)
- K** Hold switch (HOLD)
- L** Hole for car mounting base
- M** DC IN jack (DC IN 4.5 V \ominus \oplus)
- N** CD release button (PUSH)

Wired remote control **B**

- A** Skip/search buttons (◀▶)
- B** Play/stop/operation off button (▶/■)
- C** Volume control buttons (-, VOL, +)
- D** Headphone jack/ earphone jack
- E** Clip
- F** Hold switch (HOLD)
- G** EQ button (EQ)
- H** Plug

HOLD Function

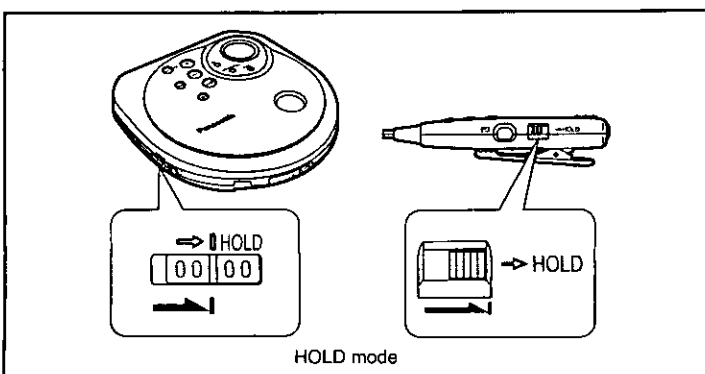

This function causes the unit to ignore short, accidental button presses. (The disc lid can still be opened and closed.)

The HOLD function prevents the following:

- The unit is powered on accidentally when not in use, causing the batteries to run down.
- A button is accidentally pressed during play, interrupting the operation.

To use the HOLD function

Set [HOLD] to the HOLD position.

The unit and wired remote control have HOLD functions, each of which works independently.

"hold" indication

When the unit is in HOLD mode, pressing any button causes the indication "hold" to appear on the display.

When the unit is powered off

The "hold" indication appears only when [▶/||] (main unit) is pressed.

Before operating the buttons

Be sure to move [HOLD] to release the unit from the HOLD mode.

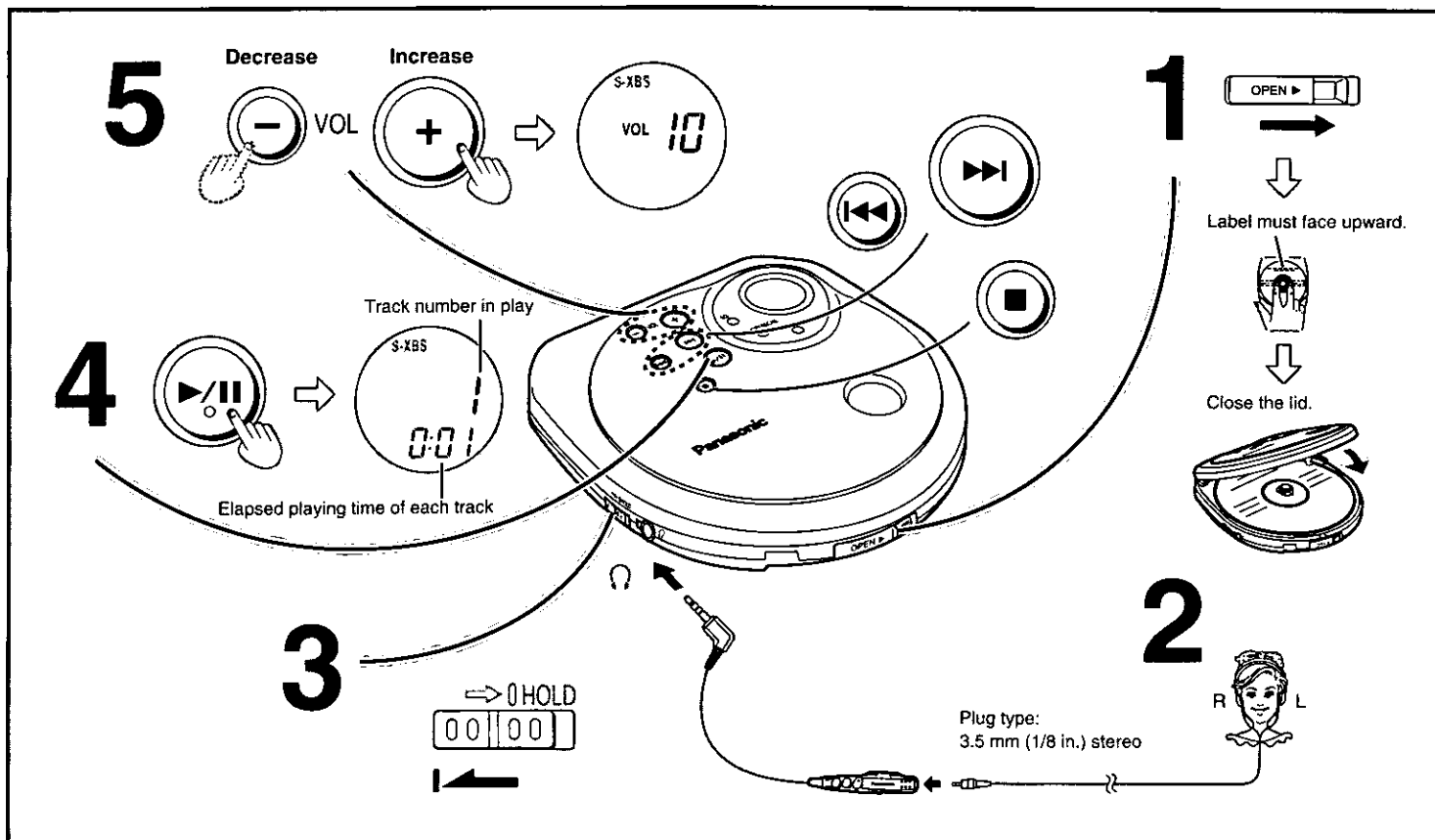

Follow steps 1–5.

In step 2: Connect the stereo headphones/earphones and wired remote control to the headphone jack [Ⓜ]. (Plug in firmly.)

In step 5: The volume range is 0-25. Press and hold to change the volume successively. The volume changes when pressed while the level is displayed. If any other display is shown, it changes to show the current level. (The volume returns to 10 when you disconnect the power source.)

- Play stops automatically when all the tracks have been played.
- If the unit has been connected to the car audio system, set this unit's volume to 10, then adjust the volume level on the system.

For your reference:

"no disc" indication

This indication appears for about 30 seconds if [▶/||] is pressed when no disc is loaded in the unit or if the disc is not properly secured.

"OPEN" indication

This indication appears for about 10 minutes when the cover is opened. (However, the indication does not appear when the unit is powered off.)

Removing discs

- 1 Press [■] to stop play and disc rotation.
- 2 Slide [OPEN ▶] to open the lid.
- 3 Press [PUSH] to release the disc.

Do not stop the disc by hand or try to remove it before it stops rotating. This can damage CDs.

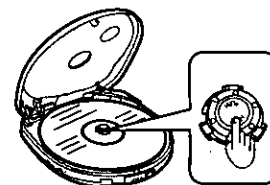

Note

Never insert foreign objects into the unit.

Auto power off function

If the unit is left in stop mode for approximately 10 minutes, the unit powers itself off automatically in order to prevent the battery from running down. (If no disc is loaded in the unit, it powers itself off in about 30 seconds.)

Note on CD-R and CD-RW

This unit can play CD-DA format audio CD-R and CD-RW that have been finalized* upon completion of recording. It may not be able to play some CD-R or CD-RW due to the condition of the recording.

*Finalizing is a process that enables CD-R/CD-RW players to play audio CD-R and CD-RW.

| Operation | Button | Display/reference |
|---|---|---|
| To pause play | Press during play. | Press again to restart play. |
| To stop play Stop mode | Press during play. Resume function Play starts from the beginning of the current track the next time you press [▶/]. | Total number of tracks Total playing time |
| To turn off the unit Off mode | Press during stop mode. | No indicator is shown. |
| Skip forward/ backward (skip function) | Press during play. (Press [◀◀] twice to skip to the beginning of the previous tracks.) | <ul style="list-style-type: none"> • During program play (page 4), these buttons are used to skip forward or backward through the programmed sequence of tracks. • You cannot skip to tracks that have been played in random or random repeat play (page 4). • During program play, 1-track repeat play, random play and random repeat play (page 4), search operation is limited to the current track only. |
| Rapid forward/ backward (search function) | Backward Forward Press and hold during play. | |

Resume function notes

- Opening the lid while in the stop mode or replacing the disc while in the off mode cancels the function. (It may remain active if you replace a disc in the off mode.)
- Play may resume from the beginning of the next track if you stopped play near the end of a track.
- The resume function works automatically and cannot be turned off.

Other Play Methods

The letters such as **E** in the various illustrations refer to the descriptions in the "Location of Controls" section (see page 2).

Skip play

The disc plays from the specified track through to the end, then play stops automatically.

Preparation: Put unit in stop mode.

1 Select the desired track.

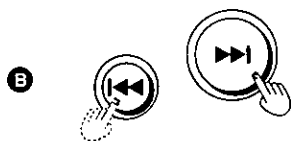

2



Changing the sound quality

Press during play or stop mode.

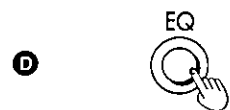

The setting switches in the sequence indicated below each time [EQ] is pressed.

S-XBS → TRAIN → Cancel (no indicator is shown)

S-XBS:

Select this setting to boost the low-range response.

TRAIN:

Select this setting to avoid annoying other passengers with noise from your headphones/earphones while riding on the train, or to reduce fatigue when listening for a long period of time.

Note

The setting returns to S-XBS when you disconnect the power source.

Program play

Up to 24 tracks can be entered in the programmed sequence.

Preparation: Put unit in stop mode.

1 Select the desired track.

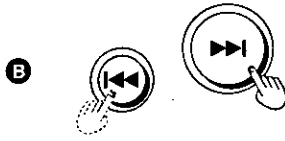

2 Register in sequence.

(The indication "M" and the programmed sequence appear on the display.)



3 Repeat steps 1 and 2 to program all the desired tracks.

4



■ **To program the same track in the sequence more than once**

After step 2, press [MEMORY/RECALL] desired number of times.

■ **If "f" is displayed**

No more tracks can be programmed.

■ **To confirm the contents of the program**

Press [MEMORY/RECALL] while the disc is playing. (The numbers of the programmed tracks appear on the display in sequence.)

■ **To delete the entire programmed sequence**

Press [■].

Note

The repeat and random play modes are canceled after steps 1 and 2.

Repeat play/Random play

Press during play or stop mode.

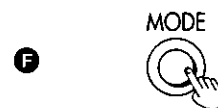

The setting is switched in the sequence indicated below each time [MODE] is pressed.

1-track repeat (1 ↻)

One track is repeated.

All-track repeat (↻)

All the tracks on the disc are repeated.

Random (RANDOM)

The tracks play once each in random order and then play stops.

Random repeat (RANDOM ↻)

The tracks play repeatedly in random order.

Cancel (no indicator is shown)

When pressed during program play

The setting is switched in the sequence indicated below each time [MODE] is pressed.

1-track repeat (1 ↻ M)

One track is repeated.

Memory repeat (↻ M)

The programmed tracks are repeated.

Cancel (M)

Note

- You can select the first track to play in random play and random repeat play by pressing [▶▶] while the disc is stopped. All the tracks are played.
- You cannot select random play or random repeat play during program play.
- The resume function does not work when random or random repeat are on.
- The mode is canceled when you disconnect the power source.

Anti-Skip System

This system deals with skipping in a variety of ways:

- An anti-skip mechanism prevents skipping caused when play speed changes due to swinging of the unit.
- A recovery system immediately returns the laser pickup to its original position if it is knocked off the track by a strong shock.
- An anti skip memory (max. 48seconds) fills in interruptions caused by bumps and vibrations.

The anti-skip system works automatically while the system is on and cannot be canceled.

When bumps continue repeatedly

The elapsed playing time disappears and sound is interrupted.

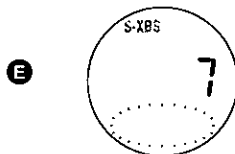

Note

- While the system is on, the disc rotates at a higher rate than usual in collecting extra audio data. This could result in a slight increase in disc rotation noise.
- The anti-skip memory compresses digital signals.

Using the Wired Remote Control

The remote control can be operated regardless of the HOLD mode of the unit.

Preparation:

Release the remote control from the HOLD mode.

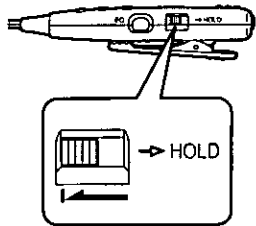

Operation confirmation tones

When an operation button is pressed, a confirmation tone sounds. Refer to the parentheses in the illustration for the different types of confirmation tones.

Turning the operation tones off and on

While stopped or during play

Press and hold [EQ] on the remote control for 5 seconds until the unit's display appears. The tone sounds when the setting is changed.

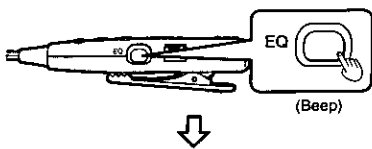

To turn the tone off

To turn the tone on

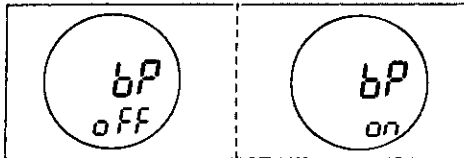

Basic operation

| | | |
|----------------------|--|--|
| To start play | Press once during off or stop mode. (Beep) | Skipping tracks Press during play. (Press [◀] twice to skip to the beginning of the previous tracks.) Backward (Beep Beep Beep) Forward (Beep Beep) |
| To stop play | Press once during play. (Beep...Beep) | |
| To turn off the unit | Press and hold during play or stop mode. (Beep...Bee...p) | To adjust the volume Press and hold during play. Decrease (Beep) Increase (Beep) •The volume range is 0-25. (Press and hold to change the volume successively.) •A tone (beep-beep) sounds when you reach the minimum or maximum volume. |

Changing the sound quality

Press during play or stop mode.

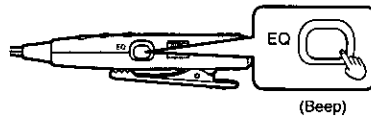

The setting switches in the sequence indicated below each time [EQ] is pressed.

S-XBS → TRAIN → Cancel (no indicator is shown)

S-XBS:

Select this setting to boost the low-range response.

TRAIN:

Select this setting to avoid annoying other passengers with noise from your headphones/earphones while riding on the train, or to reduce fatigue when listening for a long period of time.

Note

The setting returns to S-XBS when you disconnect the power source.

Using the Unit with Optional Accessories

Using the unit with an audio system

Turn off this unit and the other equipment before connection.

1 Connect the remote control to [Ⓜ] on the unit.

2 Connect the stereo connection cable to the remote control and the other equipment.

•The unit may malfunction if you connect directly to [Ⓜ] on the unit.

•Do not connect the cable to the PHONO jacks on the amplifier.

3 Turn the operation tones off (see above) so they are not heard when you press buttons on the remote control.

4 Set the volume to 10.

Make further volume adjustments with the other equipment.

Note

•Obtain the optional connecting cable if the other equipment comes with mini-phone jacks.

•If you connect speakers (active or otherwise) directly to the unit's headphone jack, ensure they have an impedance of 1 kΩ or less.

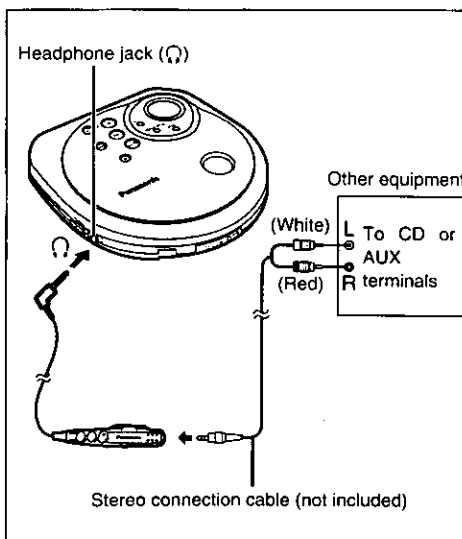

Using the unit with a car audio system

Items to be purchased

For connection to the car audio system

Car stereo cassette adaptor (SH-CDM10A)

Connect the car stereo cassette adaptor to [Ⓜ] on the unit.

(When doing this, set this unit's volume to 10.)

For securing the unit and connecting the power supply:

•Car adaptor (SH-CDC9)

•Car mounting kit (SH-CDF20)

Note when using the car mounting kit (SH-CDF20)

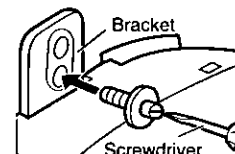

① Remove the screw from the bracket at the rear of the car mounting base.

② Replace the screw in the lower hole of the bracket.

Note

•When you switch off the car, volume and sound quality may return to the original settings and the resume function may work even if you change the disc.

•It may not be possible to use the unit with some types of car stereos owing to restrictions imposed by the construction of the car stereo cassette adaptor.

For further details, refer to the instructions of the part concerned.

ONLY FOR U.S.A.

Panasonic Consumer Electronics Company,
Division of Matsushita Electric Corporation of
America
One Panasonic Way Secaucus, New Jersey 07094

Panasonic Sales Company, Division of Matsushita Electric
of Puerto Rico, Inc.
Ave. 65 de Infantería, Km. 9.5
San Gabriel Industrial Park, Carolina, Puerto Rico 00985

Panasonic Limited Warranty

Panasonic Consumer Electronics Company or Panasonic Sales Company (collectively referred to as "the Warrantor") will repair or replace this product with new or refurbished parts or equivalent product, free of charge in the U.S.A. or Puerto Rico, in the event of a defect in materials or workmanship as follows (all time periods commence from the date of original purchase):

For one (1) year—Radio, Clock Radio, Radio with Tape Player or Recorder, Speaker

For ten (10) days—Batteries—(when applicable)—New rechargeable batteries in exchange for defective rechargeable batteries. Non-rechargeable batteries are not warranted.

For ninety (90) days—SD Memory Card—New SD card of the same memory capacity in exchange for a defective SD Card for ninety (90) days.

For assistance in the U.S.A. in obtaining repairs contact:

Panasonic Services Company
Panasonic PLUS Department
20421 84th Avenue South
Kent, WA 98032
Phone: 1-800-533-9626
FAX: 1-800-237-9080

If repair is needed during the warranty period the purchaser will be required to furnish a sales receipt/proof of purchase indicating date of purchase.

Also, the purchaser will be responsible for shipping the unit to the above address. This warranty is extended only to the original purchaser.

For assistance in Puerto Rico contact, Panasonic Sales Company.
Tel. (787) 750-4300
Fax. (787) 768-2910

This warranty only covers failures due to defects in materials or workmanship which occur during normal use and does not cover damage which occurs in shipment or failures which are caused by products not supplied by the warrantor or failures which result from accident, misuse, abuse, neglect, mishandling, misapplication, faulty installation, set-up adjustments, improper maintenance, alteration, improper antenna, inadequate signal pickup, maladjustment of consumer controls, modification, line power surge, or commercial use of the product, or damage that is attributable to acts of God, or service by anyone other than a **PANASONIC SERVICES COMPANY** Factory Servicenter.

LIMITS AND EXCLUSIONS

There are no express warranties except as listed above.

THE WARRANTOR SHALL NOT BE LIABLE FOR INCIDENTAL OR CONSEQUENTIAL DAMAGES RESULTING FROM THE USE OF THIS PRODUCT, OR ARISING OUT OF ANY BREACH OF THIS WARRANTY, INCLUDING WITHOUT LIMITATION, DAMAGE TO TAPES, RECORDS OR DISCS. ALL EXPRESS AND IMPLIED WARRANTIES, INCLUDING THE WARRANTIES OF MERCHANTABILITY, ARE LIMITED TO THE APPLICABLE WARRANTY PERIOD SET FORTH ABOVE. Some states do not allow the exclusion or limitation of incidental or consequential damages, or limitations on how long an implied warranty lasts, so the above exclusions or limitations may not apply to you.

This warranty gives you specific legal rights and you may also have other rights which vary from state to state.

If you have a problem with this product that is not handled to your satisfaction, then write to the Consumer Affairs Department at the Company address indicated above.

If you ship the product

Carefully pack and send it prepaid, adequately insured and preferably in the original carton.

Attach a postage-affixed letter, detailing the complaint, to the outside of the carton.

Do NOT send the product to the Executive or Regional Sales offices. They are NOT equipped to make repairs.

Product Service

- 1. Damage requiring service**—The unit should be serviced by qualified service personnel if:
 - (a) The AC power supply cord or AC adaptor has been damaged; or
 - (b) Objects or liquids have gotten into the unit; or
 - (c) The unit has been exposed to rain; or
 - (d) The unit does not operate normally or exhibits a marked change in performance; or
 - (e) The unit has been dropped or the cabinet damaged.
- 2. Servicing**—Do not attempt to service the unit beyond that described in these operating instructions. Refer all other servicing to authorized servicing personnel.
- 3. Replacement parts**—When parts need replacing ensure the servicer uses parts specified by the manufacturer or parts that have the same characteristics as the original parts. Unauthorized substitutes may result in fire, electric shock, or other hazards.
- 4. Safety check**—After repairs or service, ask the servicer to perform safety checks to confirm that the unit is in proper working condition.

Product information

For product information or assistance with product operation:
In the U.S.A., contact the Panasonic Customer Call Center at 1-800-211-7262, or e-mail consumerproducts@panasonic.com, or web site (<http://www.panasonic.com>).

In Canada, contact Panasonic Canada Inc. Customer Care Centre at 905-624-5505, web site (www.panasonic.ca), or an authorized Servicentre closest to you.

User memo:

DATE OF PURCHASE _____
DEALER NAME _____
DEALER ADDRESS _____
TELEPHONE NUMBER _____

Maintaining the Lens

Open the lid and clean the lens as shown in the figure. Use a cotton swab to gently wipe off any finger-prints.

Recommended product: Lens cleaner kit (SZZP1038C)

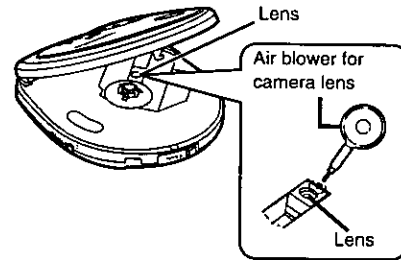

CAUTION!

THIS PRODUCT UTILIZES A LASER.
USE OF CONTROLS OR ADJUSTMENTS OR PERFORMANCE OF PROCEDURES OTHER THAN THOSE SPECIFIED HEREIN MAY RESULT IN HAZARDOUS RADIATION EXPOSURE.
DO NOT OPEN COVERS AND DO NOT REPAIR YOURSELF.
REFER SERVICING TO QUALIFIED PERSONNEL.

WARNING:

TO REDUCE THE RISK OF FIRE, ELECTRIC SHOCK OR PRODUCT DAMAGE, DO NOT EXPOSE THIS APPARATUS TO RAIN, MOISTURE, DRIPPING OR SPLASHING AND THAT NO OBJECTS FILLED WITH LIQUIDS, SUCH AS VASES, SHALL BE PLACED ON THE APPARATUS.

THE FOLLOWING APPLIES ONLY IN THE U.S.A.:

CAUTION:

This equipment has been tested and found to comply with the limits for a Class B digital device, pursuant to Part 15 of the FCC Rules.

These limits are designed to provide reasonable protection against harmful interference in a residential installation. This equipment generates, uses and can radiate radio frequency energy and, if not installed and used in accordance with the instructions, may cause harmful interference to radio communications. However, there is no guarantee that interference will not occur in a particular installation. If this equipment does cause harmful interference to radio or television reception, which can be determined by turning the equipment off and on, the user is encouraged to try to correct the interference by one or more of the following measures:

- Reorient or relocate the receiving antenna.
- Increase the separation between the equipment and receiver.
- Connect the equipment into an outlet on a circuit different from that to which the receiver is connected.
- Consult the dealer or an experienced radio/TV technician for help.

Any unauthorized changes or modifications to this equipment would void the user's authority to operate this device.

This device complies with Part 15 of the FCC Rules. Operation is subject to the following two conditions: (1) This device may not cause harmful interference, and (2) this device must accept any interference received, including interference that may cause undesired operation.

Specifications

Audio

No. of channels: 2 (left and right, stereo)
 Frequency response: 20 to 20,000 Hz
 (+0 dB to -7 dB)
 DA converter: 1 bit, MASH
 Headphone
 output level: RMS max. 8 mW+8 mW/
 16 Ω (adjustable)

Pickup

Light source: Semiconductor laser
 Wavelength: 780 nm

General

Operational temperature
 range: 0 °C-40 °C
 (32 °F-104 °F)
 Power supply: DC 4.5 V with optional
 AC adaptor RP-AC46

Play time:

[When used in hold mode with EQ canceled, at 25 °C (77 °F), on a flat, stable surface]

| Batteries used | Play time |
|----------------------|----------------|
| 2 alkaline batteries | About 40 hours |

- The play time may be less depending on the operating conditions.
- Play time will be considerably reduced when playing CD-RW.

Dimensions

(W×H×D): 128×26.3×131.5 mm
 (5 1/8"×1 1/2"×5 1/8")

Mass: 243 g (8.6 oz.) (with batteries)
 197 g (6.9 oz.) (without batteries)

Note:

Specifications are subject to change without notice.
 Mass and dimensions are approximate.

Troubleshooting Guide

Before requesting service, make the below checks. If you are in doubt about some of the check points, or if the remedies indicated in the chart do not solve the problem:

In the U.S.A., contact the Panasonic Customer Call Center at 1-800-211-7262, or e-mail consumerproducts@panasonic.com, or web site (<http://www.panasonic.com>).

In Canada, contact Panasonic Canada Inc. Customer Care Centre at 905-624-5505, web site (www.panasonic.ca), or an authorized Servicentre closest to you.

| Problem | Check this |
|--|---|
| Cannot close the cover. | Is the disc properly secured in place? |
| Cannot play discs. | <ul style="list-style-type: none"> •Is the unit in HOLD mode? •Is the disc properly secured in place? •Is there condensation on the lens? (Wait for about an hour and then try again.) •Is the disc dirty or scratched? |
| Tracks on disc do not play in order, starting with the first track. | <ul style="list-style-type: none"> •Is the random play mode on? •Did you stop play in the middle of the disc last time? |
| Cannot hear music—too noisy. | <ul style="list-style-type: none"> •Have the headphone/earphone and the wired remote control plugs inserted firmly? •Are the plugs dirty? (Wipe away dirt on plug.) •Separate the unit from mobile phones. |
| TV picture is distorted. Radio reception is noisy. | Are you using the unit too near a TV or tuner? (Keep the unit away from the TV or tuner.) |

Cautions

Listening caution



Do not play your headphones or earphones at a high volume. Hearing experts advise against continuous extended play.

If you experience a ringing in your ears, reduce volume or discontinue use.

Do not use while operating a motorized vehicle. It may create a traffic hazard and is illegal in many areas.

You should use extreme caution or temporarily discontinue use in potentially hazardous situations.

Even if your headphones or earphones are the open-air type designed to let you hear outside sounds, don't turn up the volume so high that you can't hear what's around you.

Sound can be deceiving. Over time your hearing "comfort level" adapts to higher volumes of sound. So what sounds "normal" can actually be loud and harmful to your hearing.

Guard against this by setting your equipment at a safe level BEFORE your hearing adapts.

To establish a safe level:

- Start your volume control at a low setting.
- Slowly increase the sound until you can hear it comfortably and clearly, and without distortion.

Once you have established a comfortable sound level:

- Leave it there.

Discontinue use if you experience discomfort with the headphones, earphones or any other parts that directly contact your skin. Continued use may cause rashes or other allergic reactions.

Care of dry cell batteries

To prevent battery damage, electrolyte leakage and short-circuiting, heed the following points.

- Do not peel off the covering on batteries and do not use if the covering has been peeled off.
- Align the poles ⊕ and ⊖ correctly when inserting the batteries.
- Do not mix different types of batteries or old and new batteries.
- Remove the batteries if you do not intend to use the unit for a long time.
- Do not throw into fire, short-circuit, disassemble, or subject to excessive heat.
- Do not attempt to recharge dry cell batteries.
- Do not allow metal objects to touch the battery terminals as this may cause short-circuiting which is dangerous.
- When carrying batteries in a pocket or bag, ensure no metal objects such as necklaces are placed together with them. Contact with metal may cause short-circuiting which can cause a fire.

When driving a car

In the interest of traffic safety, do not operate the unit while driving.