

* Some contents of this manual may differ from your phone depending upon the software of the phone or your service provider.



CELLULAR PHONE SCH-N391 User's Manual



World Wide Web
<http://www.samsungmobile.com>

Printed in Korea
Code No.: GH68-5749A
English. 08/2004.Rev.1.0

Please read this manual before operating your phone, and keep it for future reference.

Table of Contents

Important Safety Precautions	7
Unpacking	9
Your Phone	
Phone Layout	10
Display	11
Backlight	15
Service Light	15
Getting Started	
Using the Battery	16
Switching the Phone On or Off	20
Your Phone's Modes	21
Locking or Unlocking the Keypad	23
Call Functions	
Making a Call	24
Emergency Dialing	25
Redialing the Last Number	26
Making a Call from Phonebook	26
Prepend Dialing	27
Speed Dialing	28
Four-digit Dialing	30
Pause Dialing	30
Adjusting the Volume	34
Answering a Call	35
Rejecting a Call	36
Options During a Call	36
Using Caller ID	37
Viewing Missed Calls	38
Call Waiting	39
Three-Way Calling	40

Entering Text

Changing the Text Input Mode	42
Using T9(English) Mode	43
Using Alphabet Mode	45
Using Symbol Mode	47
Using Number Mode	47

Using the Menus

Accessing a Menu Function by Scrolling	48
Using Shortcuts.....	49
List of Menu Functions	50

Calls

Outgoing (MENU 1-1)	53
Incoming (MENU 1-2)	54
Missed (MENU 1-3).....	55
Erase History (MENU 1-4).....	55
Air Time (MENU 1-5).....	56

Phone Book

Find (MENU 2-1)	57
Add New Entry (MENU 2-2)	59
Group Setting (MENU 2-3)	62
My Phone # (MENU 2-4)	63
Memory (MENU 2-5).....	63

Messages

Text (MENU 3-1)	65
Photo (MENU 3-2)	70
Voice (MENU 3-3).....	74
Erase MSG (MENU 3-4).....	74
MSG Setting (MENU 3-5)	75

Planner

Today (MENU 4-1)	77
Scheduler (MENU 4-2)	79
Task List (MENU 4-3)	81
Memo Pad (MENU 4-4)	83
Alarm (MENU 4-5)	84
Calculator (MENU 4-6)	85
World Time (MENU 4-7)	86
Countdown (MENU 4-8)	86
Set Time (MENU 4-9)	88

Voice Tools

Voice Memo (MENU 5-1)	89
Voice Answer (MENU 5-2).....	91

Sounds

Ringer Volume (MENU 6-1)	94
Ringer Type (MENU 6-2)	95
Alerts (MENU 6-3)	96
Key tone (MENU 6-4)	97
Roam Ringer (MENU 6-5).....	97
Power On/Off (MENU 6-6)	97
Escalating (MENU 6-7)	98

Display

Menu Style (MENU 7-1)	99
Wallpaper (MENU 7-2)	99
Backlight (MENU 7-3)	100
Banner (MENU 7-4)	100
Dual Clock (MENU 7-5)	101
Service LED (MENU 7-6)	102
Contrast (MENU 7-7)	102
Power Saving (MENU 7-8)	102

Games

Fun Bowling (MENU 8-1)	104
Honey Ball (MENU 8-2)	105
Go Hamster (MENU 8-3)	107

Setup	
Auto Answer (MENU 9-1)	108
Call Answer (MENU 9-2)	108
Auto Key Lock (MENU 9-3)	109
Auto Retry (MENU 9-4)	109
Set System (MENU 9-5)	110
Data/Fax (MENU 9-6)	111
Version (MENU 9-7)	112
Security (MENU 9-8)	113

Photos	
Take Picture (MENU 0-1)	116
Photo Album (MENU 0-2)	120
Photo Wallet (MENU 0-3)	122
Settings (MENU 0-4)	123

WAP	
About the Wap Browser	124
Launch Wap ( -1)	125

Health and Safety Information	
Exposure to Radio-Frequency Energy (SAR Information)	130
Precautions When Using Batteries	131
Road Safety	133
Operating Environment	133
Electronic Devices	134
Potentially Explosive Environment	136
Emergency Calls	137
Other Important Safety Information	138
Care and Maintenance	139

Glossary	141
----------------	-----

Index	144
-------------	-----

Quick Reference Card	147
----------------------------	-----

Important Safety Precautions

Read these guidelines before using your wireless phone. Failure to comply with them may be dangerous or illegal.

Road Safety at All Times

Do not use a hand-held phone while driving; park the vehicle first.

Switch Off When Refueling

Do not use the phone at a refueling point (service station) or near fuels or chemicals.

Switch Off in Aircraft

Wireless phones can cause interference. Using them in aircraft is both illegal and dangerous.

Switch Off in Hospitals

Switch your phone off near medical equipment. Follow any regulations or rules in force.

Interference

All wireless phones may be subject to interference, which could affect their performance.

Special Regulations

Meet any special regulations in force in any area and always switch off your phone whenever it is forbidden to use it, or when it may cause interference or danger (in a hospital for example).

Sensible Use

Use only in the normal position (held to the ear). Avoid unnecessary contact with the antenna when the phone is switched on.

Emergency Call

Ensure the phone is switched on and in service. Key in emergency number 111, then press the  key. Give all the necessary information as accurately as possible. Do not end the call until given permission to do so.

Water Resistance

Your phone is not water-resistant. Keep it dry.

Accessories and Batteries

Use only Samsung-approved accessories and batteries. Use of unauthorised accessories could damage your phone and may be dangerous.

Qualified Service

Only qualified service personnel may service or repair your phone.

For more detailed safety information, see “Health and Safety Information” on page 130.

CAUTION

RISK OF EXPLOSION IF A NON-APPROVED BATTERY IS USED

DISPOSE OF USED BATTERIES ACCORDING TO THE INSTRUCTIONS

Unpacking

Your package contains the following items:



Handset



Battery



User's Manual

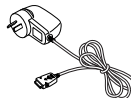

Travel Adapter



Wearable Ear-Microphone



Hand Strap

In addition, your local Samsung dealer will stock some or all of the following accessories:

- Wearable Ear-Microphone
- Travel adapter
- Standard battery
- Cigarette lighter adapter
- Hands-free car kit
- Data cable
- Car cradle
- PC link program
- Holster

Your Phone

Phone Layout

The following illustration shows the main elements of your phone.



Volume/Scroll keys
During a call, adjust the voice volume.
In Standby mode, adjusts the tone volume.
In the menu facility, scrolls through the menu options.

Display

Layout

The display has two areas; an upper line of various icons and a lower text and graphic area.

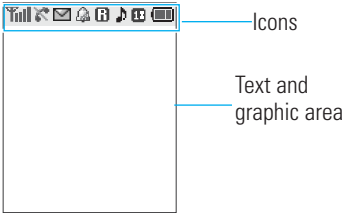

Keys

Key	Functions
	Enters Menu mode.
	In Menu mode, selects the current menu or option. In Standby mode, accesses the Messages menu.
	<i>In the menu facility</i> , scrolls through the menu options. <i>In Standby mode</i> , allows you to enter the Find Name menu, allows you to enter the Scheduler menu, and allows you to enter the Voice Memo menu.
	Quickly enters the Photos menu. Turns the camera on when held down. In the capture mode, works as a camera shutter.

Keys *(continued...)*

Key Functions *(continued...)*



Makes or answers a call.

In Standby mode, accesses the recent call logs.



Ends a call. Also switches the phone on and off when pressed and held.

In the menu facility, returns to Standby mode and cancels your input.



Deletes characters from the display.

In the menu facility, returns to the previous menu level.

In Standby mode, quickly enters the **WAP** menu. Pressing and holding down this key starts the WAP browser.



Enters numbers, letters and some special characters.



In text entry mode, changes the appearance of input.

In Standby mode, enters the Keypad Lock mode when pressed and held.



In Standby mode, quickly enters/exits the silent mode when pressed and held.

In text entry mode, inserts a space.

Icons



Signal Strength : Shows the received signal strength. The greater the number of bars, the better the signal.



Service: Appears when a call is in progress.



No Service: Appears when you are outside a service area. When it appears, you cannot make or receive calls.



New Message: Appears when a new message is received.



Alarm: Appears when you set an alarm to ring at a specified time.



Roaming: Appears when you are out of your home area and have logged onto a different network, when traveling in other countries, for example.



Ringer On: Appears when you set the ringer volume for calls from **Level 1** to **Level 8** or to **1-Beep**.



Ringer Off: Appears when you set ringer volume for calls to Silent.



Vibration: Appears when you set the ringer volume for calls to **Vibrate** or **High+Vib** or when the phone is in Silent mode.



Digital Mode: Indicates when the phone is logged onto a digital network.



1x Mode: Indicates when the phone is in 1x mode.



Battery Status: Shows the level of your battery. The more bars you see, the more power you have left.

Backlight

The display is illuminated by a backlight. When you press any key, the backlight illuminates. It turns off if no key is pressed within a given period of time, depending on the **Backlight** option set in the **Display** menu.

To specify the length of time for which the backlight is active, set the **Backlight** menu (**MENU 7-3**). See page 100 for further details.

Note: In Standby mode or Talk mode, the display automatically turns off after some time to conserve your battery power. Press any key to turn the display on.

Service Light

The service light is at the outline of the navigation key. It flashes to indicate incoming call or message. Also, the service light flashes for a few seconds when you turn on the phone.

To turn the service light on or off, use the **Service LED** menu option (**MENU 7-6**); see page 102 for further details.

Getting Started

Using the Battery

Your phone is powered by a rechargeable Li-Ion battery. Use only approved batteries and chargers. Ask your local Samsung dealer for further details.

Note: You must fully charge the battery before using your phone for the first time. A discharged battery is fully recharged in approximately 3 hours for a standard battery.

Installing the Battery

1. Insert the teeth at the bottom of the battery into the corresponding slots.

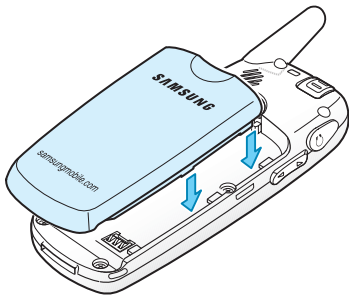

2. Push the battery against the back of the phone until it clicks into place.

Make sure that the battery is properly installed before switching the phone on .

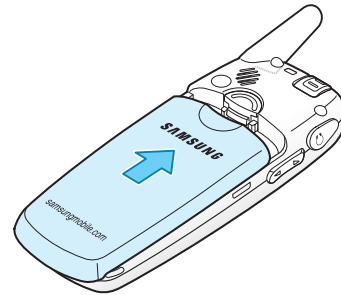

Removing the Battery

1. Switch off the phone by pressing and holding the  key down until the power-off animation is displayed.
2. To remove the battery, push and hold the catch above the battery on the back of the phone and lift the battery away.

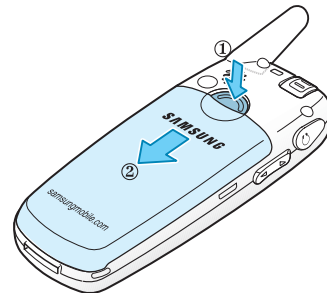

Charging the Battery

Using the Travel Adapter

Note: The phone can be used while the battery is charging, but this will cause the phone to charge more slowly.

1. Plug the travel adapter's connector into the bottom of the phone. Check that the arrow on the connector is facing towards the front of the phone.
2. Plug the adapter into a standard AC wall outlet.

A bar indicating the charging progress appears on the display. While charging, the Battery Strength icon at the top right-hand corner of the display repeatedly fills to show its charging.

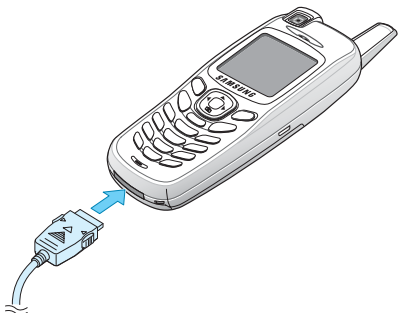

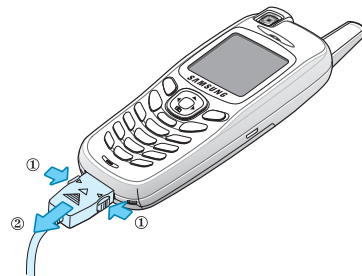

3. When charging is complete, unplug the adapter from the power outlet.

Unplug the adapter from the phone by pressing the grey tabs on both sides of the connector and pulling the connector out.



Low Battery Indicator

You can easily tell if your battery needs to be recharged by checking the Battery Status icon () at the upper-right corner of your phone's display. The presence of all three bars indicates a full charge, two bars indicates a smaller charge, and one bar indicates an even smaller charge.

When the battery charge level becomes low, the battery sensor blinks an empty Battery Status icon () and sounds a warning tone. If the battery level becomes too low, the phone automatically turns off. When this happens, you lose whatever you are doing and if in a call your phone call cuts off. Watch the Battery Status icon and make sure that your battery is adequately charged.

Switching the Phone On or Off

1. Press and hold the  key until the power-on image displays to switch the phone on.

The service light on the phone flashes and an alert sounds. When the system locates services, the greeting message displays along with the date and time. You can now place and receive calls.

If the phone is out of service, the No Service icon () appears on the display. In this case, you cannot make and receive calls. You can try again later when service is available.

2. When you wish to switch the phone off, hold the  key down for more than two seconds.



WARNING!



Do not switch the phone on when mobile phone use is prohibited or when it may cause interference or danger.

Note: As with any other radio-transmitting device, do not touch the antenna unnecessarily when the phone is switched on. Contact with the antenna affects the call quality and may cause the phone to operate at a higher power level than otherwise needed.

Your Phone's Modes

Standby Mode

Standby is the most basic state of your phone. The phone goes into Standby mode after you turn it on or whenever you briefly press the  key. When your phone is in Standby mode, you will typically see the greeting message and the current date and time. If you enter a phone number, you can press the  key to dial it or press the **OK** key to save it in the internal Phonebook.

Press the  key at any time to return to Standby mode. Be warned; if you are on a call when you press the  key, the call disconnects and the phone returns to Standby mode.

Talk Mode

You can place and answer calls only when your phone is turned on. During a call, the phone is in Talk mode. While you are in Talk mode, pressing the **MENU** key gives you a list of options. See page 36 for details.

Power Save Mode

Your phone comes with a Power Save feature that is automatically activated if your phone is unable to find a signal after 15 minutes of searching. While this feature is active, the phone's battery charge is conserved. The phone automatically rechecks for a signal periodically. To manually force the phone to recheck for a signal, press any key.



Lock Mode

When you lock your phone using the **Lock Phone** menu (**MENU 9-8-1**), you cannot use the phone. In Lock mode, you can receive messages and calls, but you cannot place an outgoing call except to an emergency number until you unlock the phone. To unlock the phone, you need to press **MENU** key and then enter the lock code.

For details about locking and unlocking your phone, see page 113.

Silent Mode

Silent mode disables all of the sounds on the phone. This feature is best used in situations where the phone might disturb others, such as in a meeting, at a library or in a theater. You can switch your phone to Silent mode with one touch of a key.

In Standby mode, press and hold  until "Entering Silent Mode" and the Vibration indicator () display.

To exit and reactivate the previous sound settings, press and hold  again until "Exiting Silent Mode" appears. The Vibration indicator no longer displays unless the ringer volume is set to 'High + Vib'.

Locking or Unlocking the Keypad

You can make the keypad lock manually by pressing and holding  in standby mode. You can prevent accidental key pressing with this key guard mode.

To lock the keypad automatically, use the **Auto Key Lock** menu (**MENU-9-3**). See page 109.

To unlock your keypad, press  and then .

Note: When the alarm or scheduler alerts or a call is received, the Key Lock mode is disabled.

Call Functions

Making a Call

In Standby mode, enter the area code and phone number and press the  key.

Or, press the last phone number and hold it down.

Note: When the **Auto Retry** menu (**MENU 9-4**) has been enabled, the phone automatically retries to make the call when the line is busy or the remote person does not answer. See page 109.

While entering a number, press the **MENU** key to use the following menu options:

Talk: places a call to the number.

Save: allows you to save the number in Phonebook.

Find: allows you to find a number from Phonebook.



Hard Pause: enters a hard pause.

2sec Pause: enters a 2-second pause.

Notes:

- When you enter a number corresponding to a Phonebook location, the **Speed Dial** option is available. For details about speed dialing, see page 28.
- When you enter four digits, the **4-digit Dial** option is available. For details about four-digit dialing, see page 30.

Correcting the Number

To clear the	Press the
last digit displayed	 key.
whole display	 key for more than one second.

Ending a Call

When you want to finish your call, briefly press the  key.

If you end the call by pressing the  key, the length of the call and the phone number display briefly and the phone returns to Standby mode.

Emergency Dialing



You can place emergency calls from your emergency number list even if your phone is locked or all of the outgoing calls are restricted.

For further details about emergency numbers, see page 114.

Redialing the Last Number

To redial the last call you made, press the  key twice quickly or press and hold the key down.

Your phone stores the last 20 numbers each of the dialed, received and missed calls. To recall any of these numbers:

1. In Standby mode, press the  key. The list of the recent calls display.
2. Press the Navigation keys until you find the name or number you want.
3. Press the  key to dial the number displayed.

Making a Call from Phonebook



You can store the phone numbers you called regularly in the phone's memory, which is called Phonebook. You then simply recall the number to dial.

For further details about the Phonebook feature, see page 57.

Prepend Dialing

The prepend option lets you add digits, such as area codes and network feature activation codes, to a phone number that is in your call logs or Phonebook.

To prepend a phone number stored in your phone:

1. Access outgoing call logs by pressing the  key or Phonebook entries by referring to page 57.
2. Scroll to the number you want to dial.
3. Press the **MENU** key to access the options.
4. Press the **3** key to select the **Prepend** option.
5. Enter the area code or feature code.
6. Press the  key to dial the number.

Speed Dialing

Once you have stored phone numbers in Phonebook, you can dial them easily whenever you want.

Notes:

- When several numbers are saved in one name entry, the first number you entered is automatically specified as a speed dial number. To change the speed dial number, use **Speed dial** in the Phonebook options; see page 60.
- You can also speed dial selecting **Speed Dial** from the dialing options (see page 60). Enter a number corresponding to a Phonebook location, press the **MENU** key and then press the **Speed Dial** option.

One-Touch Dial

Memory locations 001 through 009 are special one-touch locations. You can dial the phone numbers stored in the Phonebook memory from 001 through 009 simply by pressing one key.

Press and hold the third digit of the memory location containing the number to be dialled.

For example: Location no. 009
Press the **9** key and hold.

The number (and name) stored displays and is then dialled.

Two-Touch Dial

Memory locations 010 through 099 are special two-touch locations.

Press the second digit briefly, then hold down the third digit of the memory location.

For example: Location no. 023
Press the **2** key briefly and hold down the **3** key.

The number (and name) stored displays and is then dialled.

Three-Touch Dial

Memory locations 100 through 900 are special three-touch locations.

Press the first two digits briefly, then hold down the third digit of the memory location.

For example: Location no. 123
Press the **1** key and the **2** key briefly, then hold down the **3** key.

The number (and name) stored displays and is then dialled.

Four-digit Dialing

You can quickly dial a phone number in Phonebook by entering its last four consecutive digits.

1. Enter the last four digits of the phone number you want to dial.
2. Press the **MENU** key and select the **4-digit Dial** option. The phone displays the phone number matching the four digits.

If the phone found more than one number that contains those four digits, it displays the first number. Scroll through the number using the ◀ and ▶ keys to select a number.

3. Press the **↶** key to dial the number.

Pause Dialing

When you call an automated system, like a banking service, you are often required to enter a password or account number. Instead of manually entering the numbers each time, you can store the numbers in your Phonebook, separated by pauses.

There are two kinds of pauses that can be entered on your phone:

- **Hard pause:** A hard pause stops the dialing sequence until you press the **↶** key.

- **2-second pause:** A two second pause stops the dialing sequence for two seconds and then automatically sends the remaining digits.

Note: Multiple two second pauses can be entered to extend the length of a pause. keep it mind that pauses count as digits towards the 32 digit dialing maximum.

Storing Pauses in a Phonebook Entry

To store a number in your Phonebook that contains pauses:

1. Enter the phone number you want to store, such as the bank's teleservice phone number.
2. Press the **MENU** key to access the options.
3. Select the pause type you want and press the **OK** key.
 - Press the **4** key for **Hard Pause**. The letter "P" displays, meaning that a hard pause will occur at that point in the dialing sequence.
 - Press the **5** key for **2sec Pause**. The letter "T" displays, meaning that a timed pause will occur at that point in the dialing sequence.
4. Enter the digits that need to follow the pause, such as your account number.
5. Repeat steps 2 through 4 to add more pauses and numbers, if necessary.
6. Store the number in your Phonebook as you normally would by pressing the **OK** key and following from step 2 on page 59.

Pause Dialing from a Stored Phonebook Entry



1. Dial the number of the service you want to call from the Phonebook.
2. If you stored the number using a hard pause(s), wait for the appropriate prompt from the number you are calling. When prompted, press the  key to send the DTMF (Dual Tone Multi-Frequency) number that follows your pause.

If you stored the number using a two second pause(s), your phone transmits the number that follows the “T” pause two seconds after the connection.

3. “Sending DTMF” flashes on the display and the transmitted tone sounds.
4. Repeat from step 2, if necessary.

Manual Pause Dialing



You can enter pauses manually during the dialing process.

1. Enter the phone number of the service you want to call, such as a bank’s teleservice phone number.
2. Press the **MENU** key to access the options.
3. Select the pause you want and press the **OK** key.
 - Press the **4** key for **Hard Pause**. The letter “P” displays, meaning that a hard pause will occur at that point in the dialing sequence.
 - Press the **5** key for **2sec Pause**. The letter “T” displays, meaning that a “Timed” pause will occur at that point in the dialing sequence.
4. Enter the number to be sent after the pause and then press the  key to dial the first number.
5. For a hard pause, press the  key again at the prompt to send the additional number after connecting.

If you enter the number using a 2-second pause(s), the phone sends the number that follows the pause two seconds after the connection.

Adjusting the Volume

During a call, if you want to adjust the voice volume, use the Volume keys on the left side of the phone.

Press the  key to increase the volume level and the  key to decrease the level.

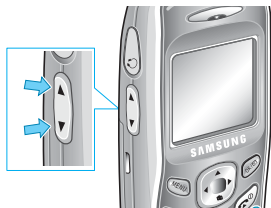



In Standby mode, you can also adjust the keypad tone volume using these keys.

Answering a Call

When somebody calls you, the phone rings and displays the incoming call animation.

If the caller can be identified, their phone number will display. If the caller is saved in your Phonebook then their name and number will display.

There are two ways to answer a call depending on your setting in the **Call Answer** menu (**MENU 9-2**):



If you select	To answer the call,
Any Key	press any key, except the  and the volume keys.
SEND Key	press  .

To end the call, press the  key.

Notes:

- You can answer a call while using Phonebook or menu functions. The current operation stops.
- If you cannot answer incoming calls, you can set the phone to answer the call by playing a greeting message and record callers' messages. For further details, see page 91.

Rejecting a Call

If you press the  key or one of the volume keys once, when a call is received, the phone stops ringing or vibrating. You can still answer the call by pressing the  key. Press the  key to disconnect without answering the call.

Options During a Call

Your phone provides you with a number of functions that you can use during a call.

Press the **MENU** key during a call to access the following options:

Phone Book: allows you to access the **Phone Book** menu. For details, see page 57.

Mute/Quit: allows you to switch your phone's microphone off, so that the other person cannot hear you.

Example: You wish to say something to a person in the room but do not want the caller to hear you.

Silent/Quit: does not transmit the key tones. It allows you to press keys without hearing annoying key tones during a call.

Send Tel #: sends your telephone number to your caller.

Calls: allows you to access the **Calls** menu. For details, see page 53.

Messages: allows you to use the **Messages** menu. For details, see page 64.



Planner: allows you to access the **Planner** menu. For details, see page 77.

Using Caller ID

This feature tells you who is calling you by displaying the caller's number when the phone rings. If the name and number are stored in your Phonebook, the corresponding name also displays. If you call someone who has this feature, your phone number displays on her/his phone.

Viewing Missed Calls

If you fail to answer a call for any reason, the phone indicates the missed call by displaying a text notification on the screen. Additionally, if caller information is available, a Missed entry is created.

Press the  key to place a call, the **OK** key to save the number or the  key to clear the notification and return to Standby mode.

To view missed calls, access the **Missed** menu (**MENU 1-3**). For details, see page 55.



Call Waiting

Call Waiting lets you receive a second call during a conversation. Your phone notifies you of a waiting call by beeping and displaying “Call Waiting.”

Your network provides you with the option of turning the Call Waiting feature on and off, if you have subscribed to the service. Call Waiting is on by default in the phone. If you choose to have an undisturbed conversation, simply turn off the feature for the current call.

Note: Contact your service provider to activate the Call Waiting service.

To answer a waiting call during a call:

1. When you hear a beep telling that you have a waiting call, press the  key. The phone connects the calling person and places the current call on hold.
2. Press the  key again to switch between the two calls.



Note: If you do not respond to a Call Waiting notification, the phone will forward the call to voice mail server or another number that you have set up. Contact your service provider for more information.

Three-Way Calling

This feature enables you to conduct conference calls with two separate people at the same time. The phone records each participant into the Outgoing Calls Log. Also, you are billed call time for each outgoing call separately.

Note: Contact your service provider to activate Three-Way Calling.

To place a Three-Way call:

1. During a conversation, press the  key. The phone places the other person on hold.
2. Enter the phone number for the third person, and then press the  key. The phone dials the third person.
3. When you are connected to the person, press the **3** key and then the  key again to begin your three-way call.

If one of the callers (not you) hangs up, you and remaining caller stay connected. If you initiated the call and you hang up first, all three participants are disconnected.

Entering Text

At many times when using your phone, you will need to enter text, such as when storing a name in your Phonebook, creating your personal greeting or scheduling events in your calendar. You can enter alphanumeric characters into your phone using your phone's keypad.

Your phone has the following text input modes:

- **T9(English):** This mode allows you to enter words with only one key press per letter. Each key on a keypad has more than one letter; for example, when you press the **5** key once J, K or L displays. T9 mode automatically compares your key presses to an internal linguistic database to determine the correct word. T9 mode requires far fewer keystrokes than the traditional multi-tap method, Alphabet mode.
- **Alphabet:** This mode allows you to enter letters by pressing the key labeled with the letter you want repeatedly until the desired letter appears on the display.
- **Symbol:** This mode allows you to enter special characters.
- **Number:** This mode allows you to enter numbers.

Changing the Text Input Mode

When you are in a field that allows character entry, you should notice the text input mode indicator on the display.

Example: Entering a name for a Phonebook entry

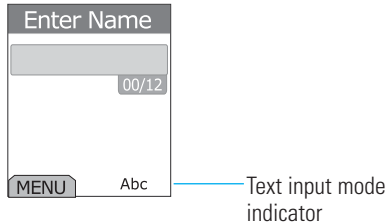

To change to another text input mode:

1. Press the **MENU** key.

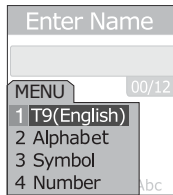

2. Scroll to the mode by pressing the ▲ or ☑ key.
3. To select the highlighted mode, press the **OK** key. If you want to exit the menu without changing to a new mode, press the #/0 key.

The selected text input mode indicator appears on the display.

Using T9(English) Mode

To type a word, press keys corresponding to the letters you need. Remember the following as you are typing:

1. Press alphanumeric keys on the keypad just once per letter. For example, to enter "Hello," press the **4**, **3**, **5**, **5** and **6** keys once.

The word you are typing appears on the display. It may change with each key press.

2. Type to the end of the word before editing or deleting any keystrokes.
3. Put a space between words by pressing the #/0 key.

If the word that appears on the display is not the one that you desire, press the **0** key one or more times to display alternative word choices for the keys you have typed. For example, both "Of" and "Me" use the **6** and **3** keys. The phone displays the most commonly used choice first.

4. Continue entering the next word.

Smart Punctuation

Periods, hyphens, and apostrophes are available by pressing the **1** key. T9 mode applies rules of grammar to insert the correct punctuation. Notice that the **1** key is used twice in this example to display two punctuation marks:



Including a Number

You can include a number between letters without exiting the T9 input mode. Press and hold the corresponding number key.





Changing the Case

Your phone has three cases:

- **T9Word**: the initial letter is capitalised, then following words appear in lower-case.
- **T9WORD**: all letters are capitalised.
- **T9word**: all letters are in lower-case.

Press the  key one or more times to display the appropriate case indicator and begin typing normally.

Other Usages

- Press the  key to insert a space.
- To move the cursor to the left or right through your text, press the  or  key.
- Press the  key one or more times to delete the letters one by one to the left. Press and hold the  key to clear the display.

Using Alphabet Mode

When typing in Alphabet mode, you need to press the keys labeled with the letter you want:











- Once for the first letter
- Twice for the second letter
- And so on

This method is called multi-tap typing.

For example, you press the **2** key three times to display the letter “C” and the **5** key two times to display the letter “K.”

The cursor moves to the right when you press a different key. When entering the same letter twice or a different letter on the same key, just wait for a few seconds for the cursor to move to the right automatically, and then enter the next letter.

Refer to the table below for the list of characters assigned on each key.

Key	Characters in the Order Displayed
	. , - ? ! ' @ : 1
	A B C 2
	D E F 3
	G H I 4
	J K L 5
	M N O 6
	P Q R S 7
	T U V 8
	W X Y Z 9
	0

(Caps Lock mode)

Including a Number

You can quickly include a number between letters. Press and hold the corresponding number key.



Changing the Case

Your phone has three cases:

- **Abc**: the initial letter is capitalised, then following words appear in lower-case.
- **ABC**: all letters are capitalised.
- **abc**: all letters are in lower-case.

Press the  key one or more times to display the appropriate case indicator, and begin typing normally.

Other Usages

- Press the  key to insert a space.
- To move the cursor to the left or right through your text, press the ◀ or ▶ key.
- Press the  key one or more times to delete the letters one by one to the left. Press and hold the  key to clear the display.

Using Symbol Mode

Symbol mode enables you to enter symbols.

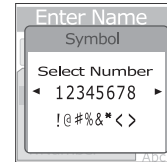

You can display more symbols by pressing the ◀ or ▶ key.

Press the number key corresponding with the symbol you want to enter. The phone automatically switches back to the text entry mode used just prior to selecting Symbol mode.

Using Number Mode

Number mode enables you to enter numbers.

Press the keys corresponding with the digits you want to enter and manually switch back to the text entry mode of choice. For details about changing the mode, see page 42.

Using the Menus

Your phone offers a range of functions that allow you to tailor it to your needs. These functions are arranged in menus and submenus.

The menus and submenus can be accessed by scrolling or by using the shortcuts.

Accessing a Menu Function by Scrolling

1. In Standby mode, press the **MENU** key to access Menu mode.
2. Scroll using the Navigation keys to view the heading of each of the main menu options; for example, **Setup**. Press the **OK** key to enter the menu.
3. If the menu contains any submenus; for example, **Auto Answer**, find the one you want by scrolling using the **▲** or **☐** key. Press the **OK** key to enter the submenu.

If the menu you have selected contains submenus, repeat this step.

4. Scroll using the **▲** or **☐** key to find the setting of your choice.
5. Press the **OK** key to confirm the chosen setting.

Notes:

- You can return to the previous menu level by pressing the **Ⓢ** key.
- You can exit the menu without changing the menu settings by pressing the **☎** key.

Using Shortcuts

Menu, submenu and setting options are numbered and can be quickly accessed by using their shortcut numbers.

Note: The numbers assigned to each menu function are indicated on the list on page 50.

1. In Standby mode, press the **Menu** key to access Menu mode.
2. Enter the first digit of the shortcut number. Repeat this for each digit of the shortcut number.

Example: Accessing the **Auto Answer** menu

Press the **9** and **1** keys.

9 selects **Setup** and **1** selects **Auto Answer**.

3. Find the setting of your choice by pressing the **▲** or **☐** key.
4. Press the **OK** key to confirm the chosen setting.

List of Menu Functions

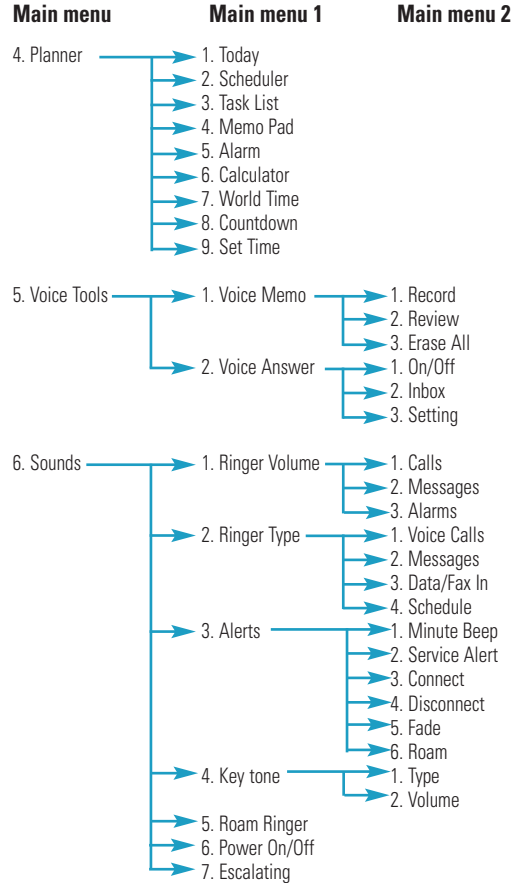
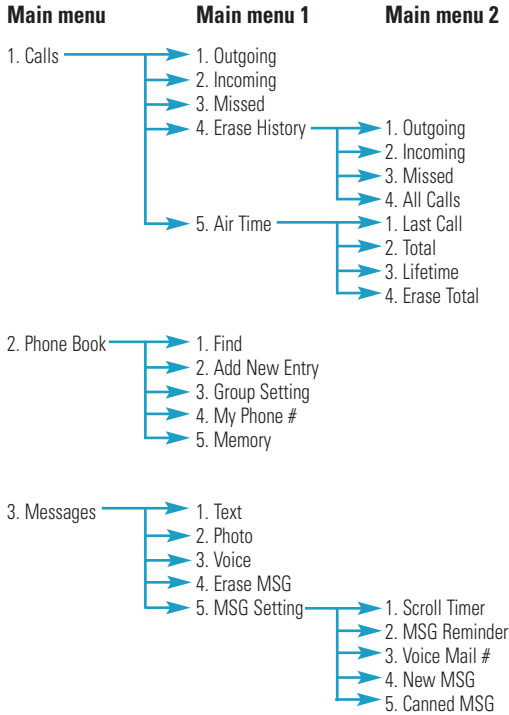

Main menu

7. Display

Main menu 1

- 1. Menu Style
- 2. Wallpaper
- 3. Backlight
- 4. Banner
- 5. Dual Clock
- 6. Service LED
- 7. Contrast
- 8. Power Saving

8. Games

- 1. Fun Bowling
- 2. Honey Ball
- 3. Go Hamster

9. Setup

- 1. Auto Answer
- 2. Call Answer
- 3. Auto Key Lock
- 4. Auto Retry
- 5. Set System
- 6. Data/Fax
- 7. Version
- 8. Security
 - 1. Lock Phone
 - 2. Change Lock
 - 3. Restriction
 - 4. Emergency #
 - 5. Erase Pbook
 - 6. Reset Phone

0. Photos

- 1. Take Picture
- 2. Photo Album
- 3. Photo Wallet
- 4. Settings

Main menu 2

Calls

You can use the **Calls** menu to:



- view and dial the last calls you dialed, received or missed.
- erase the numbers in the call log memory.
- view the length of calls.



Outgoing

MENU 1-1

Note: You can also access the Recent Call List by pressing the  key in Standby mode.

The phone stores up to 20 of the last calls you dialed. When you access this menu, a list of the outgoing calls displays.

1. Press the  or  key to find a number, or name if it is saved in Phonebook.
2. Press the **OK** key to confirm the highlighted number. The dialed number and name if it is saved in the Phonebook, displays along with the date and time when the call was made.

To	Press the
place a call to the selected number	 key.
use the options	MENU key. For details, see the next page.
exit the call log	 key.

When you press the **MENU** key on the call log screen, the following options are available:

Talk: dials the number.

Save: (shown when the number is not stored in your Phonebook) allows you to save the number in Phonebook.

Show Entry: (shown when the number is stored in your Phonebook) displays the phone number and memory location number.

Prepend: allows you to add an area code or feature code to the number before dialing the number. See page 27 for details.

Erase: erases the selected number.

Incoming

MENU 1-2

This menu lets you view up to 20 of the last calls you received.

When you access this menu, a list of the incoming calls displays.

For more information about scrolling through the list and accessing the call log, see “Outgoing” on page 53.

Missed

MENU 1-3

Your phone keeps a list of the last 20 incoming calls that you failed to answer. Contact your service provider for further details about the service.

When you access this menu, a list of the missed calls displays.

For more information about scrolling through the list and accessing the call log, see “Outgoing” on page 53.

Erase History

MENU 1-4

You can erase the entries stored in each of the three call logs or all three logs at once.

When a confirming message displays, select **Yes** to erase the selected log or all of the logs. If you want to cancel the selection, select **No**. Press the **OK** key to confirm the selection.

Air Time

MENU 1-5

Your phone records the amount of air time, or talk time, used. Using this menu, you can view the number of the calls to or from your phone, and the air time for calls you made. You can easily erase the call time record at any time. This menu is convenient for estimating your usage.

Note: This feature is not intended to be used for billing purposes.

The following options are available:

Last Call: shows the time of the last outgoing call.

Total: shows the number of outgoing calls you made and the total duration of the calls since the time counter was last set to zero by using the **Erase Total** option.

Lifetime: shows the number and total duration of all calls you made or received your phone since the phone was shipped from the factory.

Erase Total: erases the “Total” time measurement and resets the air time counter.

Phone Book

Phonebook allows you to store frequently used phone numbers and the associated names in your personal directory to make it easy for you to make a call without having to remember or enter the phone number. You can store up to 900 entries including E-mail and URL addresses.

Memory location 001 is reserved for the number of your voice mail. You can change or delete the number, if necessary.

Find

MENU 2-1

This menu allows you to find an entry in your Phonebook.

Note: You can access this menu by pressing the **▲** key in Standby mode.

1. Press the **◀** or **▶** key to scroll to the method you want to use.
 - **By Name:** Enter the first few letters of the name you want with Alphabet mode. The Phonebook entries are listed starting with the first entry matching your input.
 - **By Entry:** Enter the location number of the number you want to find, using the numeric keys.
 - **By Group:** Press the **☎** key and select the group containing the entry you want to find, using the **◀** or **▶** key. The phone lists all of the entries in the selected group.

- If necessary, press the ▲ or ☎ key to scroll through the entries.
- When the entry you want highlights, press the **OK** key to access the entry. The phone shows the details about the name.

4. To	Press the
place a call to the selected number	☎ key.
use the options	MENU key. For details about the options, see below.

When you press the **MENU** key on the details screen, the following options are available:

Talk: place a call to the number.

Edit: allows you to change the phone number, name, location number, label category and so on.

Prepend: allows you to add digits, such as area codes, ahead of the selected number before dialling. See page 27 for further details.

Erase: erases the selected entry.

Note: The options available are different depending on the item you selected on the screen.

Add New Entry

MENU 2-2

This menu allows you to store a number with a name in your Phonebook. You can save a person's numbers, such as their home number, workplace number, mobile number, pager number and fax number, into one entry. A Phonebook entry can contain up to six numbers, one in each category.

Creating a New Entry

- Enter a phone number and press the **OK** key.
- Press the **OK** key to confirm to add a new entry.
- Select an icon to identify the category of the number to be stored using the Navigation keys and press the **OK** key.
- Enter a name and press the **OK** key. For further details about entering characters, see page 41.
- To select an option, scroll to it by pressing the ▲ or ☎ key. The following options are available:
 - **Enter Name:** allows you to enter a name of up to 12 characters, if you didn't in step 4. For further details about how to enter text, see page 41.
 - **Entry:** The first available location displays. If necessary, enter the location number using the number keys.

- **Home/Work/Mobile/Pager/Fax/No label:** allows you to store more numbers for each category.
 - **Speed dial:** allows you to select one of the stored numbers for speed dialing.
 - **E-mail:** allows you to store an e-mail address.
 - **URL:** allows you to store a URL address.
 - **Group:** allows you to assign the entry to a caller group. To remove the entry from a group, select **No Group**.
 - **Name Ringer:** allows you to select the unique ringer to be used for alerting you to an incoming call from the person.
 - **Birthday:** allows you to save the date of the person's birthday.
 - **Secret:** allows you to prevent a number from being displayed when it is accessed or dialed by unauthorised users. When this option is set to **ON**, only people with your phone's lock code can view the secret number.
 - **Image:** allows you to select an image to be used for alerting you to an incoming call from the person.
6. Press the **MENU** key to enter information or use the ◀ or ▶ key to change the settings.
 7. When you finish setting the options, press the **OK** key.

8. When a confirming message appears, select **Yes** and press the **OK** key to save the entry.

After storing, the phone displays the Phonebook entry number that you just saved and the number of remaining slots you can store further phone numbers in.

Storing Phone Numbers at Call's End

To store a phone number at the end of your call:

1. Press the  key to end the call. The call time and the phone number display.
2. To store the phone number, press the **OK** key.
3. To complete storing the number, follow the procedure from step 2 in "Creating a New Entry" on page 59.

Adding a Number into an Existing Entry

1. Enter a number and press the **OK** key.
2. Scroll to the entry where you want to add a number by pressing the ▲ or  key. Press the **OK** key.
3. To complete storing the number, follow the procedure from step 3 in "Creating a New Entry" on page 59.

Group Setting

MENU 2-3

This menu allows you to change the name and ringer settings for the caller groups.

1. Scroll to the group you want to edit using the ▲ or ▢ key.
2. Press the **MENU** key. The following options are available:
 - **Rename:** allows you to change the group name.
 - **Sounds:** allows you to select a ringer melody to indicate when a call comes in from any member of the group.
3. Select an option and press the **OK** key.
4. Enter a name or select the sound you want and press the **OK** key.

For further details about how to enter text, see page 41.
5. Repeat steps 2 through 4, if necessary.

My Phone

MENU 2-4

This menu shows you your phone number.

After viewing, press the **OK** key to return to the previous screen.

Memory

MENU 2-5

This menu shows you how many Phonebook locations are used or empty.

After viewing, press the **OK** key to return to the previous screen.

Messages

Your phone can receive voicemail notification, text messages, and pages. Also, your phone can send text messages and pages if your system supplier provides this service.

When the phone receives a message, an alert sounds, a text notification displays along with the name or phone number of the caller if available. The New Message icon (✉) remains on the screen until you read the new text, numeric page or web message, or you listen to the new voicemail messages.

Messages are received even when your phone is in Lock mode. To access a message, you must unlock the phone.

To enter the Messages menu, press  in Standby mode.

Text

MENU 3-1



New MSG (MENU 3-1-1)

You can create a SMS (Short Message Service) message and send it to other mobile phones.

Note: Message transmission is available only when your phone is operating in a digital network and if the service is supported by your service provider.

1. Enter a destination number using the numeric keys.
Pressing the **MENU** key allows you to search your Phonebook for a number.
2. To send your message to multiple destinations, press the  key and enter another number. Repeat this step, as needed. You can enter up to 10 destinations.
3. When you are finished, press the **OK** key.
4. Enter the message contents. For further details about how to enter text, see page 41.

When you press the **MENU** key, the **Canned MSG** option is available to allow you to use the ten canned messages preset in the **MSG Setting** menu; for details, see page 76.

5. When you finish entering the message, press the **OK** key.
6. To select an option, press the  or  key and press the **OK** key.

The following options are available:

- **Send To:** allows you to change the send-to phone number.
- **Message:** allows you to change the message contents you've already entered.
- **Callback #:** allows you to set the call back number. It is preset to your phone number at the factory.
- **Options:** displays the following setting options. Change the setting using the ◀ or ▶ key.
 - Message Save: Set whether or not the phone saves the message in the Outbox after transmission. When you select **Prompt Save**, the phone asks if you want to save the message.
 - Send Later: Selects how long the delivery of the message will be delayed at the SMS center, if you do not want to send it immediately.
 - Delivery Ack: turns the delivery acknowledgement feature on or off. When this is activated, the network informs you whether or not your message has been read by the recipient.
 - Priority: selects the message priority.

Note: **Message Save** options can be preset in the **New MSG** option (**MENU 3-5-4-2**); for details, see page 76.



- **File Msg:** allows you to store the message in the **Filed MSG** menu for future use.
7. Repeat step 6 to set the message options.
 8. After changing the setting options, press the  key to send the message.

Note: Pressing the  key before the message is sent stops the transmission.

Inbox (MENU 3-1-2)

Your phone can store up to 98 messages total in the Inbox, the Outbox and the Filed Message box. When the memory is full, the phone automatically deletes the messages from the oldest one to receive additional messages.

When you access the **Inbox** menu, the message list appears. Unread messages are italicised on the list.

To view details of a message, press the ▲ or  key (or the ◀ or ▶ key) to scroll to the message on the list and press the **OK** key. If necessary, press the ▲ or  key to scan through the contents.

You can view the next or previous page using the volume key.

While viewing a message, press the **MENU** key to use the following options:

Reply: allows you to send a reply message to the sender.

Forward: allows you to forward the message to another person.

Delete: deletes the message from the Inbox.

Talk: places a call to the callback number.

Save #: allows you to save the callback number of the message.

Lock/Unlock: the **Lock** option allows you to keep the message from being deleted. The message cannot be erased until unlocked using the **Unlock** option.

Outbox *(MENU 3-1-3)*

Your phone can store up to 98 messages total in the Inbox, the Outbox and the Filed Message box.

When you access the **Outbox** menu, the message list appears.

To view details of a message, press the ▲ or ☐ key (or the ◀ or ▶ key) to scroll to the message on the list and press the **OK** key. If necessary, press the ▲ or ☐ key to scan through the contents.

You can view the next or previous page using the volume key.

While reviewing a message, press the **MENU** key to use the following options:

Resend: allows you to resend the message. For further details, see page 66.

Delete: deletes the message from the Outbox.

Filed MSG *(MENU 3-1-4)*

Your phone can store draft messages that are yet to be sent in the Filed Message box. If you save the message contents using the **File MSG** menu before sending it (see page 66), you can access them using this menu.

To review a stored message, press the ▲ or ☐ key to scroll to it and press the **OK** key.

While reviewing a message, press the **MENU** key to use the following options:

Resend: allows you to resend the message. For further details, see page 66.

Delete: deletes the message from the Filed Message box.

Photo

MENU 3-2

This menu allows you to use the Multimedia Message Service (MMS), which allows you to send or receive messages containing images or sounds. To send an MMS message, you can use photos you have taken or images or sounds downloaded from the wireless web.

New MSG (MENU 3-2-1)

You can send a message with a photo from your Photo Album or an image from the My Image folder.

Sending a Multimedia Message

1. Enter the destination phone number or e-mail address.
2. If you want to send the message to more than one person, use comma “,” or a space between the numbers.

You can access your Phonebook by pressing the **MENU** key and selecting Phonebook.

3. Press the  key.
4. Enter a title for your message.

You can change the text input mode just by pressing the **MENU** key.

For further details about entering characters, see page 41.

5. Press the  key twice.
6. Select **Album** or **My Images** by pressing the **MENU** key and press the **OK** key.

7. Select a photo or image and press the **OK** key.
The selected photo or image displays.
8. Press the  key.
9. Write a message and press the  key.
10. If you want to attach sound, select a melody, voice memo or record something new by pressing the **MENU** key and selecting the appropriate option.
11. Preview the message you have created by pressing the **OK** key.

You can send the message by pressing **SEND** key with out previewing the message.
12. Press the **SEND** key to send the message.

Inbox (MENU 3-2-2)

When you save received messages from the web server to your phone's memory, your phone stores them in this menu. When a new multimedia message comes in, a text notification displays.

Select a message using the Navigation key and:

To	Press the
read the message text	OK key.
delete single or all the message/s	MENU key.

While viewing a message, press the **MENU** key to use the following options:

Reply: replies to the sender by sending a text message or multimedia message.

Reply all: replies to the sender's, Bcc, CC addresses by sending a text message or multimedia message..

Forward: to Forward the same message to a different person.

Delete: deletes the message.

Info: shows detailed information about the message.

Save Address: saves the sender's phone number in the **Phone Book** folder.

Save Image: saves the image in the **My Images** folder.

Save to Wallet: saves the image in the **Photo Wallet** folder.

Save Sound: allows you to save the sound in the **My Melodies** folder.

Outbox (MENU 3-2-3)

In this menu, you can review sent messages.

Select a message using the Navigation key and:

To	Press the
read the message text	OK key.

While viewing a message, press the **MENU** key to use the following options:

Go to: allows you to send the message again.

Delete: deletes the message.

Info: show detailed information about the message.

Draft box (MENU-3-2-4)

In this menu, you can review the messages your phone was unable to send.

On the message list, scroll to a message and:

- Press the **MENU** key to use the following options:

Go to: allows you to edit the message so that you can send the message again and save it in the menu.

Delete: deletes the message.

Info: shows detailed information about the message.

Alert (MENU 3-2-5)

Press the **OK** key and select menu to download message or delete, your phone alerts you and the following options display:

Download: allows you to download the Web Inbox to display the wap message.

Delete: deletes the message.

Voice

MENU 3-3

When a voice message is received, your screen will display 'New voicemail'. Press the  key and the phone dials the voice mail center.

If multiple new voice messages are received but not checked, information of the last one will be displayed. The information display includes the time/date stamp and the number of new voice messages.

If you access your voice messages through **MENU 3-3**, you can press the **MENU** key to access the following options:

Listen: allows you to listen to the voice message. The phone automatically dials the number of your voicemail center.

Clear Icon: clears the New Message icon and if necessary, resets the counter for a new voice message, if necessary. The system resets the counter automatically after you listen to all of the new messages.

Note: You can also access your voicemail box by pressing and holding  in standby mode.

Erase MSG

MENU 3-4

Using this menu, you can erase all of the messages in each message box in the **Text**, **MMS** and **Voice** menus. You can also erase all of the messages at one time by selecting **All Messages**.

When a confirming message appears, select **Yes** and press the **OK** key.



MSG Setting

MENU 3-5

In this menu, you can preset several options for using the messaging feature.

Scroll Timer (MENU 3-5-1)

If an incoming text message is too long for the display, the phone displays it by scrolling the screen automatically. You can set how often the phone scrolls the message to the next screen.

If you select **Off**, you need to scroll to the next screen manually using the  or  keys.

MSG Reminder (MENU 3-5-2)

When a message is received, the phone alerts you by sounding the selected ringer. You can set how often you want to be alerted. Selecting **Off** means that the message alert sounds once when the message is received. Selecting **Once** means that the message alert sounds once when the message is received and sounds again after 2 minutes. Selecting **Every 2 min** means that the message alert sounds every 2 minutes.

Voice Mail # (MENU 3-5-3)

This menu allows you to view or change the voice mail server number, if necessary.

Note: Voice mail is a network feature. Please contact your service provider for further details.

New MSG (MENU 3-5-4)

You can change the default settings of the options for creating a new message. The following options are available:

Callback #: allows you to set the call back number. It is preset to your phone number at the factory.

Save Message: allows you to set whether or not you want the transmitted message to be saved in the Outbox.

- Do Not Save: The phone does not save the message.
- Prompt Save: The phone asks you whether or not you want to save the message.
- Auto Save: The phone automatically saves the message.

Entry Method: allows you to select the text input mode either **T9 Word** (T9 English) or **Alphabet**. For further details about how to enter text, see page 41.

Delivery Ack: allows you to activate or deactivate the delivery acknowledgement. If activated you will receive a text to confirm your message was delivered.

Priority : allows you to select the message priority

Retrieval Mode : allows you to choose automatic to download and display messages as they are received.

Canned MSG (MENU 3-5-5)

This menu allows you to change the ten canned messages.

1. Scroll to a message on the list and press the **MENU** key.
2. Change the message as needed. For further details about entering characters, see page 41.
3. When you are finished, press the **OK** key.

Planner

The Planner feature enables you to:

- keep track of important dates and events.
- create a list of things to do and memos.
- set an alarm to ring at a specific time.
- use the phone as a calculator.
- check the time in another part of the world.
- count down to a specific day.
- set the current date and time.

Today

MENU 4-1

You can schedule up to 9 events for the current day, indicating each event's start and end time. You can even have your phone's calendar alert you before an event commences. Events scheduled for future dates automatically appear on your Today events schedule on that day.

Scheduling a New Event

1. Enter a name for your event contents and press the **OK** key.

For further details about entering characters, see page 41.

2. Enter the start time and date using the numeric keys.

You need to enter the time in 12-hour format. Press the **2** key for **A** (AM) or the **7** key for **P** (PM).

Note: You can move through the input fields using the Navigation keys.

3. Enter the end time and date using the number keys.
4. Select when an alarm will inform you of the event, by pressing the ◀ or ▶ key. Selecting **No Alarm** means that no alarm will sound.
5. Press the **OK** key to store your event.

Viewing Your Today's Schedule

The list of the events stored on the current day displays when you select the **Today** menu (**MENU 4-1**).

While viewing the event list, press the ▲ or ☒ key to scroll to an event and:

- Press the **OK** key to view the event information. To view the Start time and End time settings, use the ▲ and ☒ keys. You can move to the previous or next event by pressing the ◀ or ▶ key.

While viewing the event, press the **MENU** key to use the following options:

Edit: allows you to change the event.

Erase: allows you to erase the event.

- Press the **MENU** key to use the following options:

Add New: allows you to add a new event.

Erase: allows you to erase the selected event.

Erase All: allows you to erase all of the events.

Scheduler

MENU 4-2

This menu allows you to view the current month, as well as past or future months, in calendar format. On the calendar, the current day appears in gray and days with scheduled events are indicated by a colored box inside the calendar day.

Note: You can quickly access this menu by pressing the ◀ key in Standby mode.

Scrolling Through the Calendar

- You can move by one day by pressing the ◀ or ▶ key.
- You can move by one week by pressing the ▲ or ☒ key.
- To display the next or previous month, press the ⏪ or ⏩ key.

On the calendar, press the **MENU** key to use the following options:

View: allows you to view the scheduled events of the day.

Add New: allows you to add a new event on the day.

Erase All: allows you to erase all of the events.

Creating a New Schedule

You can store up to 70 events in total in the scheduler, with up to 9 events for any one day.

1. Select a day on the calendar, referring to “Scrolling Through the Calendar” on page 79 and press the **OK** key.

2. Enter a name for your event contents and press the **OK** key.

For further details about entering letters, see page 41.

3. Enter the start time and date using the numeric keys.

You need to enter the time in 12-hour format. Press the **2** key for **A** (AM) or the **7** key for **P** (PM).

Note: You can move through the input fields using the Navigation keys.

4. Enter the end time and date using the number keys.
5. Select when an alarm will inform you of the event, by pressing the ◀ or ▶ key.

Selecting **No Alarm** means that the phone does not ring the alarm.

6. Press the **OK** key to store your event.

Viewing Your Schedule

Select a day with scheduled events on the calendar, referring to “Scrolling Through the Calendar” on page 79 and press the **OK** key. The first event stored on the day displays.

To view the Start time and End time settings, use the ▲ or 📅 keys.

While viewing the event, press the **MENU** key to use the following options:

Edit: allows you to edit the event.

Erase: allows you to erase the event.

Task List

MENU 4-3

This feature allows you to enter a list of tasks to be done and assign both a priority and a deadline to each task.

Creating a New Task

1. Enter the first task and press the **OK** key to confirm.

For further details about how to enter characters, see page 41.

2. Enter the time and date by which the task needs to be done, using the numeric keys.

You need to enter the time in 12-hour format. Press the **2** key for **A** (AM) or the **7** key for **P** (PM).

Note: You can move through the input fields using the Navigation keys.

3. Select high or low priority using the ◀ or ▶ key and then press the **OK** key to store the task.

Viewing a Task

The list of the tasks displays when you access the **Task List** menu (**MENU 4-3**).

While viewing the task list, press the ▲ or ☐ key to scroll to a task and:

- Press the **OK** key to view details. You can move to the previous or next task by pressing the Navigation keys.

While viewing the task, press the **MENU** key to use the following options:

Edit: allows you to edit the task.

Erase: allows you to erase the task.

- Press the **MENU** key to use the following options:

Add New: allows you to add a new task.

Erase: allows you to erase the selected task.

Erase All: allows you to erase all of the tasks.

Memo Pad

MENU 4-4

This feature allows you to write down memos about anything you need to remember.

Writing a New Memo

1. Enter the memo details.

For further details about how to enter characters, see page 41.

2. Press the **OK** key to save the memo.

Viewing a Memo

The list of your memos displays when you access the **Memo Pad** menu (**MENU 4-4**).

While viewing the memo list, press the ▲ or ☐ key to scroll to a memo and:

- Press the **OK** key to view details. You can move to the previous or next memo by pressing the Navigation keys.

While viewing the memo, press the **MENU** key to use the following options:

Edit: allows you to edit the memo.

Erase: allows you to erase the memo.

- Press the **MENU** key to use the following options:

Add New: allows you to add a new memo.

Erase: allows you to erase the selected memo.

Erase All: allows you to erase all of the memos.



Alarm

MENU 4-5

This menu allows you to set up to three alarms to ring at a specific time.

To set an alarm:

1. Select an alarm, **Alarm #1** through **Alarm #3**, and press the **OK** key.
2. Select **On** by pressing the ◀ or ▶ key.
3. Press the  key and enter the time for the alarm to ring.

You need to enter the time in 12-hour format. Press the **2** key for **A** (AM) or the **7** key for **P** (PM).
4. Press the  key and select an alarm melody by pressing the ◀ or ▶ key.
5. Press the  key and select an alarm type, either **Daily** or **Once**, by pressing the ◀ or ▶ key.
6. Press the **OK** key to save the alarm setting.

To stop the alarm when it rings, press any key.

To deactivate an alarm setting, access it from the alarm list and select **Off** on the top line.



Calculator

MENU 4-6

Using this feature, you can use the phone as a calculator. The calculator provides you with the basic arithmetic functions; addition, subtraction, multiplication and division.

1. Enter the first number on the first line using the numeric keys.

Notes:

- To erase mistakes or clear the display, press the  key.
 - Use the  key to enter a decimal point and the  key to change the sign of a number to a negative (-).
2. Enter the operation for your calculation on the second line by pressing the Navigation keys, according to the graphic on the display.
 3. Enter the second number.
 4. Repeat steps 2 and 3 as many times as required.
 5. To view the result, press the **OK** key.

World Time

MENU 4-7

This menu allows you to check the current time for 24 world time items of 35 major cities around the world.

Select the city corresponding to your time zone by pressing the Navigation keys one or more times. The local date and time display.

To turn the DST (Daylight Saving Time) setting on:

1. After selecting the time zone you want to apply the DST, press the **MENU** key.
2. When **DST setting** highlights, press the **OK** key.
3. Select **On** and press the **OK** key. The DST icon appears on the left of the time.

To cancel the setting, select **Off**.

Countdown

MENU 4-8

This feature tells you how many days, hours and minutes until a specific day arrives. You can create up to 9 counters using this menu.

Creating a New Counter

1. Enter the details for your counter and press the **OK** key.
For further details about entering text, see page 41.

2. Enter the time and date you want to count down from.

You need to enter the time in 12-hour format. Press the **2** key for **A** (AM) or the **7** key for **P** (PM).

Notes:

- You can move through the input fields using the Navigation keys.
- You can enter a year between 1980 and 2099.

3. Press the **OK** key to store the counter.

Viewing a Counter

The list of the counters displays when you access the **Countdown** menu (**MENU 4-8**).

While viewing the counter list, press the **▲** or **☐** key to scroll to a counter and :

- Press the **OK** key to view details. You can move to the previous or next counter, press the Navigation keys.

While viewing a counter, press the **MENU** key to use the following options:

Edit: allows you to edit the counter.

Erase: allows you to erase the counter.

- Press the **MENU** key to use the following options:
 - Add New:** allows you to add a new counter.
 - Erase:** allows you to erase the selected counter.
 - Erase All:** allows you to erase all of the counters.

Set Time

MENU 4-9

Your phone's date and time is continuously updated by the network. To change the date and time on the idle screen or to use the Planner features, such as **Today**, **Scheduler**, **Task List**, **Countdown**, and **Alarm**, you need to use this menu.

Enter the time and date using the numeric keys.

The hour, minute, day and month each must be entered using 2 digits and the year requires all 4 digits. You need to enter the hour in 12-hour format. To select AM or PM, press the **2** key for **A** (AM) or the **7** key for **P** (PM).

Note: If you change the date and time, these settings will automatically update back to the CDMA network time if your phone is turned off.

Voice Tools

In this menu, you can use the phone's voice features, allowing you to:

- record a voice memo.
- set the phone to answer a call and record the caller's message.

Voice Memo

MENU 5-1

Note: You can quickly enter this menu by pressing the ► key in Standby mode.

Record (MENU 5-1-1)

You can record up to 4 minutes of voice memos. This feature shares the memory with the Voice Answer feature and the amount of time for memos are dependent on the available memory less any callers' messages; for example, if your phone has the callers' messages of 4 minutes total, you cannot record any voice memo.

1. Record a memo by speaking in to the microphone.

When you are recording, a timer displays to show you the elapsed time.

You can pause recording by pressing the ◀ key and then resume by pressing the ► key.

2. Press the **OK** key to end recording. The screen provides you with the following choices. Scroll to an option and press the **OK** key.

- **Review:** allows you to review the voice memo. The screen displays the length of the memo along with the date and time.
 - **Rerecord:** allows you to discard the current memo and record another one.
 - **Save:** allows you to save the voice memo.
 - **Quit:** allows you to quit recording the memo and exit the **Record** menu.
3. When you are satisfied, select the **Save** option and press the **OK** key.
 4. Enter a title for the memo and press the **OK** key.

Review *(MENU 5-1-2)*

When a list of your voice memos displays, scroll to the memo you want to review and press the **OK** key. The phone plays the memo. You can pause playing by pressing the ◀ key and resume by pressing the ▶ key.

On the memo list, press the **MENU** key to use the following options:

Play: plays the memo.

Erase: erases the selected memo.

Info: shows detailed information about the memo, such as the title, length, memory size, date and time the memo was recorded.

Erase All *(MENU 5-1-3)*

This menu allows you to erase all of the voice memos.

When a confirming message displays, select **Yes** and press the **OK** key.

Voice Answer

MENU 5-2

If you are not able to answer an incoming call, you can set your phone to answer a call with the preset greeting message and record the caller's message. As this feature shares the memory with voice memos, the total length of messages is dependent on the available memory less any voice memos.

On/Off *(MENU 5-2-1)*

This menu allows you to enable or disable Voice Answer mode.

Inbox *(MENU 5-2-2)*

You can listen to the callers' messages recorded in your phone. When you access this menu, a list of the recorded messages appears.

Note: If the phone has the callers' messages waiting to be checked, it displays the total number of the messages and caller's number. Pressing the **OK** key takes you to the Inbox.

Press the ▲ or ☒ key to scroll to a message and press the **OK** key to play it.

You can pause playing by pressing the ◀ key and then resume by pressing the ▶ key.

On the message list, press the **MENU** key to the following options:

Play: plays the selected message.

Erase: erases the selected message.

Info: shows detailed information about the message, such as caller's number if identified, length, memory size and date and time the message was recorded.

Talk: places a call to the caller's number, if identified.

Setting (MENU 5-2-3)

You can change the settings for the voice answer mode. The following options are available:

Greeting: Your phone provides you with the default greeting message to be played when a call comes in. You can also record your own greeting message.

To record a greeting message:

1. Select **Record** and press the **OK** key.
2. Wait until a beeping prompt sounds and record a greeting message by speaking into the microphone.

You can pause recording by pressing the ◀ key and then resume by pressing the ▶ key.

3. When recording is complete, press the **OK** key. The phone automatically saves and activates the message.

If you want to play back the currently selected message, highlight **Play** and press the **OK** key.

To enable or disable your own greeting message:

1. Highlight **Select** and press the **OK** key.
2. Select **My Message** to use your message or **Default** to use the default message.
3. Press the **OK** key to save your selection.

Note: Once you have recorded your own message and then have changed the greeting to the default message, your message is deleted.

Screening: allows you to enable or disable the screening speaker which allows you to listen to the caller's message while the caller is leaving it.

Wait Time: allows you to set how long the phone waits before answering a call with the greeting message. Selecting **OFF** means that the phone plays back the message as soon as a call comes in.

Sounds

You can use the **Sounds** menu to customise various sound settings, such as the:

- ringer volume, type, and tone.
- key tone and alert sounds.
- ringer for incoming calls when you are roaming.
- sound which plays when the phone is switched on or off.

Ringer Volume

MENU 6-1

This menu allows you to adjust the ringer volume.

Calls: allows you to adjust the ringer volume for incoming voice calls.

Messages: allows you to adjust the ringer volume for incoming messages.

Alarms: allows you to adjust the ringer volume for alarm settings.

Press the Navigation keys to adjust the volume level. The following options are available:

- Silent: the phone does not sound a ring.
- Vibrate: the phone switches to the vibration mode. An incoming call vibrates the phone.
- 1-Beep: the phone sounds a beep.
- Level 1 ~ 8: adjust the volume level. The more bars, the louder the volume.
- High+Vib: the phone rings in the highest volume level and then vibrates.

Notes:

- The options available may be different depending on the selected ringer item.

Ringer Type

MENU 6-2

This menu allows you to set the unique ringer melodies for the following items:

Voice Calls: allows you to set a unique ringer for incoming voice calls. Use the navigation key to choose between Ring Tones and Melodies and My melodies.

Messages: allows you to have a distinctive ring for incoming voice mail, text, photo messaging and WAP alerts independently.

Data/Fax In: allows you to be alerted with a distinctive ringer when you receive data or fax calls through the phone. This feature may not be available depending on your network.

Schedule: allows you to have a distinctive ring for schedule settings.

Select a unique ringer using the Navigation keys. Press the **OK** key to save the ringer.

Alerts

MENU 6-3

Your phone gives audible alerts (beeps) at a specified time to inform you that certain things have happened. The alerts only occur in your earpiece so that the other person does not hear them.

The available alerts are:

Minute Beep: When this option is set to **On**, the phone sounds an alert 10 seconds before each elapsed minute to remind you of the length of the current call.

Service Alert: When this option is set to **On**, the phone sounds an alert when you exit a service area or when you return to a service area.

Connect: When this option is set to **On**, the phone sounds the connect tone when your call is connected to the system.

Disconnect: When this option is set to **On**, the phone sounds the disconnect tone when a call is disconnected.

Fade: When this option is set to **On**, the phone sounds an alert when a dropped call occurs during conversation in response to a signal fade.

Roam: When this option is set to **On**, the phone sounds an alert when your phone starts roaming.

Key tone

MENU 6-4

Using this menu, you can set up the keypad tone that the phone sounds when you press a key.

The following options are available:

Type: allows you to select a tone that the phone sounds when you press a key. Choose either **Beep**, **Rain Drop**, **Drum Sound**, or **Lady's Voice**.

Volume: allows you to adjust the volume of the keypad tone using the Navigation keys or the Volume keys on the left side of the phone.

Roam Ringer

MENU 6-5

You can set the phone to use a distinctive ring for incoming roaming calls.

Choose **Distinctive** to use a distinctive ringer or **Normal** to use a normal ringer.

Power On/Off

MENU 6-6

You can turn on or off the tone that the phone sounds when it is switched on or off.

Choose **On** to use the power on/off sound or **Off** not to use it.

Escalating

MENU 6-7

When this menu is set to **On**, the phone increases the volume as it rings, from the lowest volume level to the specified level. For example, when you set the ring volume to Level 5, the phone rings from the level 1 to 5.

If you don't want to use this feature, select **Off**. The phone rings in the specified volume level.

Display

The Display feature enables you to:

- change the display style of the menus.
- select an image to be displayed in Standby mode
- set the length of time for the backlight.
- set a banner message to be displayed.
- select the time zones for the dual clock.
- turn the service light on or off.
- Adjust the screen contrast of LCD screens.

Menu Style

MENU 7-1

This menu allows you to select the menu display style.

You can choose either **Camera** or **Nature**.

Wallpaper

MENU 7-2

You can change the background image (wall paper) to be displayed in Standby Mode.

Select one of default images in the **Embedded Images** menu, pictures you have taken in the **Photo Wallet** menu or images you downloaded from the internet or images you downloaded from the MMS in the **My Images** menu.

When you select **Dual Clock**, the phone displays the analog clocks for the two time zones selected in the **Dual Clock** menu (**MENU 7-5**). See page101.

Backlight

MENU 7-3

You have several options for setting how the LCD backlight operates. Remember that backlight use drains your battery faster.

The following options are available:



30 seconds: The backlight switches on when you press a key and switches off 30 seconds after that. Then the display turns off after 30 seconds. If you set the **Power Saving** menu (**MENU 7-8**) to Enable, the display turns off after 30.

8 seconds: The backlight switches on when you press a key and switches off 8 seconds after that. Then the display turns off after 52 seconds. If you set the **Power Saving** menu (**MENU 7-8**) to Enable, the display turns off after 52.

Banner

MENU 7-4

This menu allows you to set a banner message to be displayed at the bottom of the display in Standby mode.







1. If necessary, press the  key to delete each letter of the old banner. Press and hold the  key to clear the display.
2. Enter your banner message. For further details about how to enter characters, see page 41.
3. When you finish entering the message, press the **OK** key to save the new banner.

Dual Clock





MENU 7-5

You can choose two time zones to be displayed when you select **Dual Clock** for the wallpaper image; for details, see page 99.

To select time zones for the dual clock:

1. When **Location** highlights, press the  key.
2. Select the time zone for the first clock by pressing the  or  key and press the  key.
3. Select the time zone for the second clock by pressing the  or  key.
4. Press the **OK** key to confirm the selection.
5. To set the DST (Daylight Saving Time), see below.
To exit, press the **CLR** or  key.

To apply the daylight saving time:

1. When **Location** highlights, press the  or  key to display **DST**. Press the  key.
2. Select **Yes** to use the daylight saving time for the first clock. Otherwise, select **No**.
3. Press the  key and repeat step 2 for the second clock.
4. Press the **OK** key to confirm the selection.

Service LED





MENU 7-6

This menu allows you to select whether or not the service light on the phone is used.

Contrast

MENU 7-7

This menu allows you to adjust the brightness of the **LCD** screens.

1. Press the  or  key to make the screen darker, and  or  key to make the screen brighter. You can also use the volume keys to adjust the brightness.

Each time you press the key, you will see the selected status of the LCD.

2. Press the  key to save your setting.

Power Saving

MENU 7-8

This menu allows you to set the display to turn off after the backlight turns off so that you can conserve your battery power.

Enable : After the backlight turns off, the display turns off, depending on the setting in the **Backlight** menu (**MENU 7-3**). See page 100.



Disable : After the backlight turns off, the display remains on.



Games

You can enjoy three fun games on your phone:

- Fun Bowling (**MENU 8-1**)
- Honey Ball (**MENU 8-2**)
- Go Hamster (**MENU 8-3**)

To start a game:

1. Select a game by pressing the  or  key and press the **OK** key.
2. The following options are available. To select an option, press the corresponding number key:
 - **New Game**: allows you to start a new game.
 - **High Score**: shows you the High Score table.
 - **Key Info**: shows you the key helper screen.
 - **Continue**: allows you to continue the last game you played.

To end the game, press the  or  key.

Note: You can turn the game sound off by entering silent mode. To enter silent mode, press and hold the 'hash/pound' key from the Standby screen.

Fun Bowling





Menu 8-1

The goal of the game is to knock down a triangular group of ten pins by rolling a ball.

When you start a new game, you can select the required mode.

When the game starts, the screen shows the character and ball. Move the character first, then select the spin and direction, and finally set the power of the ball.

Key Commands

To...	Then press...
Move left	
Move right	
Set the speed or spin or throw the ball	
Pause/Resume the game	

Honey Ball

Menu 8-2

The goal of the game is to break honey blocks by bouncing a ball between a bat and the honey blocks.

When you start a new game, the ball is sitting on the bat in the middle of the screen. Once you start the ball moving, you must position the bat, so that the ball continues to bounce off it. Each time the ball hits a honey block, the block breaks, sometimes revealing letters that enhance the efficiency of the bat or ball:

B: the bat and ball change back to their standard form.











C: the ball sticks to the bat each time it hits it, giving you time to optimise your position.

H: the bat increases in length.

P: the ball is changed into a power ball, so that it no longer bounces off the blocks. It goes straight through them, destroying anything that it touches.

If you reach the final stage of the game, the rules are slightly different. The honey blocks are much stronger and need to be hit more than once before they are destroyed. At the same time, small bees attack the bat, damaging it a little each time until it is destroyed and you lose a life.

Key Commands

To...	Then press...
Slope up (right side)	 .
Slope up (left side)	 .
Move left	 ,  .
Move right	 ,  .
Hit the ball	 ,  or  .
Pause/Resume the game	 .











Go Hamster

Menu 8-3

Go Hamster is an arcade board game. It requires patience and discretion. The aim is to remove about 80% of the background while avoiding the mushroom bombs in order to progress to the next stage.

When the start screen appears, press any key to start the game.

Key Commands

To...	Then press...
Move up	 ,  .
Move left	 ,  .
Move right	 ,  .
Move down	 ,  .
Stop	 .
Pause/Resume the game	 .

Setup

Many different features of your phone can be customised to suit your preferences.

Auto Answer

MENU 9-1

With this menu activated, the phone automatically answers calls after a specified time. This feature works only when the phone is connected to an optional hands-free car kit or ear-microphone and is useful while driving, for instance.

To activate this feature, set how long the phone waits before answering. Select either from **After 5 sec**, **After 3 sec** or **After 1 sec**.



To deactivate the feature, select **OFF**.

Call Answer

MENU 9-2

This menu allows you to select how to answer an incoming call.

The following options are available:

Any Key: The phone answers when you press any key except for the  or  key.

SEND Key: The phone answers only when you press the  key.

Auto Key Lock

Menu 9-3

You can set the phone to automatically lock the keys if no key is pressed within a given amount of time. This feature is useful to avoid pressing keys by mistake.

To use this feature, select the length of time for which the phone waits before it locks the keypad.

15 Seconds, **30 Seconds** and **1 Minute** are available.

If you don't want to use this feature, select **Off**.

Note: You can manually lock the keypad. For further details, see page 23.

Auto Retry

MENU 9-4

When this menu is activated, your phone automatically redials when a connection fails.

To activate this feature, set how often the phone will automatically retry the call. Select one from **60 Seconds**, **30 Seconds** and **10 Seconds**.

To deactivate the feature, select **Off**.

Set System

MENU 9-5

Roaming is a feature which is only relevant in areas where there are at least two mobile service providers having valid roaming agreements. Roaming allows you to register your phone on one of the networks, but use the facilities of the other if your own network is not available. This system priority feature allows you to program your phone for optimum operation within or outside your home service area.

You should always check your phone's display because it will let you know when you're outside the service provider network and whether your phone is operating in another network; the Roaming icon () appears.

You have the following options which allows you to control the phone's roaming ability:

Home Only: With this setting, you cannot roam. When your home system is not available, your call will not be connected and the No Service indicator () displays.

Standard: Your phone will automatically search for the first available service according to the Preferred Roaming List supplied by the service provider.

Data/Fax

MENU 9-6

Your phone is capable of sending and receiving digital data and fax calls when connected to a computing device (laptop, desktop, handheld, palmtop, etc.) running Windows 95, Windows 98, Windows NT or later versions. The phone functions just like a typical modem on your PC, enabling you to use wireless data involving a wide variety of Windows software applications.

To use digital data or fax services with your phone, you will need to obtain a digital data/fax kit from your phone accessories provider. This kit contains the necessary cables, software, and user guide required for you to connect and use your phone with your computing device.

Note: The phone must be on a digital network to receive or send faxes and data.

The following options are available:

Voice Call Only: Your phone receives voice calls only.

Fax in Only: Your phone receives fax calls only.

Data in Only: Your phone receives data calls only.

Receiving a Fax or Data File

To receive a fax or data file, ensure that your phone is connected to your PC and is powered on. Select one of the Data/Fax options.

When you receive a fax call, set up the Answer mode in the fax program on your PC and click on **Receive** and select one of the following:

- Automatic Receive (recommended)
- Manual Receive

Sending a Fax or Data File

When connected to a computing device, your phone allows wireless fax and data transmissions. Your computing device software initiates the call to the destination phone number. The phone functions as a wireless modem to send the fax or data file to the number designated by your PC software.

Version

MENU 9-7

This menu allows you to view the software and hardware versions of your phone. This feature is helpful if you need to call the customer care centre.

Security

MENU 9-8

Your phone provides you with many security options, including a user-programmable lock code and call restriction features.

To access the **Security** menu, you need to enter a lock code. The lock code is preset to "0000" at the factory.

Lock Phone *(MENU 9-8-1)*

When the phone is locked, you cannot operate the phone until you enter the lock code. However, you can receive incoming calls or make calls to 111 or emergency numbers.



The following options are available:

Unlocked: The phone remains unlocked.

On Power-Up: The phone locks automatically the next time you turn it on.

Lock Now: The phone locks immediately.

To place an emergency call, enter 111 and then press the  key. The phone recognises three emergency numbers stored in the **Emergency #** menu (**MENU 9-8-4**).

To unlock the phone, press one of the **MENU, OK, **, Volume keys,  or Navigation keys and enter the lock code.

Change Lock (MENU 9-8-2)

This feature allows you to change your current lock code to a new one. The lock code is preset to "0000" at the factory.

Enter a new, four-digit lock code and then press the **OK** key.

Restriction (MENU 9-8-3)

This feature allows you to restrict all of the outgoing calls.

Select **On** to restrict the calls, or **Off** to deactivate the restriction.

Emergency # (MENU 9-8-4)

Your phone provides you with the option of storing four emergency numbers. All of these numbers can be manually dialed at any time even when your phone is locked or all of the outgoing calls are restricted.

IMPORTANT NOTICE!

Emergency calling may not be available on all wireless networks at all times. A connection cannot always be guaranteed, due to various transmission methods, network parameters and user settings used to complete a call from your wireless phone.

DO NOT depend on this phone as a primary method of dialing 111 or for any other essential or emergency communications. Remember to always turn your phone on and check for the adequate signal strength before placing a call.

To store an emergency number:

1. Press the **▲** or **☰** key to select a location and press the **OK** key.
2. If necessary, press and hold the **CLR** key to clear the old number.
3. Enter the number you want.

Each emergency number can be up to 32 digits long.

4. Press the **OK** key to store the number.

To make an emergency call in the lock mode, simply enter a programmed number, and then press the **↶** key.

Erase Pbook (MENU 9-8-5)

This feature allows you to clear all of the entries in your Phonebook.

When a confirming message displays, select **Yes** and press the **OK** key.

Reset Phone (MENU 9-8-6)

Resetting the phone cancels all of your selections in the user-selectable setting options and returns them to the factory default settings.

When a confirming message displays, select **Yes** and press the **OK** key. The phone turns itself off and back on, then returns to Standby mode.

Photos

Using the camera module embedded in your phone, you can take pictures of people or events while on the move. You can set a picture as a wall paper image or caller image.

- Note:**
- Do not take pictures of people without their permission.
 - Do not take pictures in a place where the use of a camera is not allowed.
 - Do not take pictures in a place where you may interfere other's privacy or secret information may be revealed.

Take Picture

MENU 0-1

In this menu, you can take a picture. The camera produces JPEG pictures.

When you take a picture in direct sunlight or in bright conditions, shadow may occur on the picture.

Taking a Picture

1. Accessing the **Take Picture** menu turns on the camera at the top left of the phone. Or, press and hold the  key in Standby Mode.

The image to be captured appears on the display.

2. Adjust the image by rotating the camera module and aiming it at the subject.

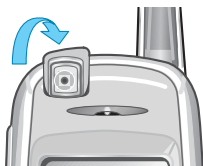

To	Press the
flip the image vertically	the volume up key.
flip the image horizontally	the volume down key
zoom in or out the image	◀ or ▶ key.
change the image resolution	▲ key.
use the options	MENU key. See the next page.
review the pictures stored in your Photo Album	OK key. For details, see page 120.
return to the capture mode from the review screen	CLR key.

The numbers on the top right of the display tell you the total number of the pictures you saved and the minimum number of the pictures you can take with the current resolution.

You can zoom the image up to four times with the resolution setting to **Low** and up to two times with the resolution setting to **Med**.

4. Press the  key to take the picture.
5. Press **OK** to save the picture.
You can also press **MENU** to cancel the picture.
6. Enter a title for your picture.
7. Press the **OK** key.

The picture is automatically saved in the **Photo Album** menu (**MENU 0-2**).

8. When you are finished, press the  key.

Using the Camera options

When you press the **MENU** key in the capture mode, the following options are available for the current shot:

Flash

This option allows you to use the flash of the camera. the following option are available.

Off : allows you to turn off the flash.

On This Shot : allows you to turn on the flash for the current shot. After you take a photo, the flash turns off.

Always On : allows you to use the flash when you take a photo.

Self Timer

You can set the phone to take a picture after a predefined time. Once you set the time, the timer () appears on the top right of the image. When you press the **ok** key, it counts down to the specified time and turns orange before three seconds. The phone automatically takes and saves a picture when the time expires.

Brightness

You can adjust the brightness of the image. Use the Navigation keys to find the status you want. When the brightness is set to **Auto**, the phone automatically determines the setting.

Fun Frames

This option allows you to use a frame on the picture. Press the Navigation keys to find the frame format you want to use.

Color Tones

This options allows you to change the color tone of the picture. Press the Navigation keys to find the tone you want to use. **Auto, Mono, Sepia, Negative, Emboss, Sketch, UV Positive, UV Negative** are available. To set the phone to select a color tone, select **Auto**.

White Balance

This setting adjusts the color balance of the picture to remove the current lighting conditions add. With this setting, you can make your picture appear warm or cool. To adjust the balance manually, select **Manual** and press the Navigation keys to find the setting you want to use.

Photo Album

MENU 0-2

In this menu, you can review the pictures you have taken. By default, your phone displays them in the thumbnail mode, which shows a picture as a small image.

The numbers on the top right of the display tell you the index number of the current picture and the total number of the pictures you saved.

To	Press the
scroll through the pictures	Navigation keys.
use the options	MENU key. For details, see the next page.
switch the view mode between the expand and thumbnail modes	OK key.

Using the Picture Options

When you press the **MENU** key while reviewing a picture, the following options are available:

Camera

This option switches the display to the capture mode. For further details about taking a picture, see page 116.

Send Photo

This option allows you to send a message with a photo from your Photo Album. For further details about sending MMS, see page 70.

Save to Wallet

This option copies the picture to the **Photo Wallet** menu (**MENU 0-3**). See the next page.

Erase

You can erase the selected picture or all of the pictures.

Edit Caption

This option allows you to change the picture's title displayed on the right top of the picture in the expand mode. For further details about how to enter text, see page 41.

Photo Info.

This option shows you information about the picture, such as title, time and date when it was taken, image size and quality. Press the Navigation keys to scroll the screen by one item.

Expand/Thumbnail

This option shows you the currently selected image in Expand mode or Thumbnail mode.

Photo Wallet

MENU 0-3

Photo Wallet allows you to store the pictures independently, like your photo album. By default, your phone displays them in the thumbnail mode, which shows a picture as a small image.

The numbers on the top right of the display tell you the index number of the current picture and the total number of the pictures you saved.

To	Press the
scroll through the pictures	Navigation keys.
use the options	MENU key. For details, see below.
switch the view mode between the expand and thumbnail modes	OK key.

When you press the **MENU** key while reviewing a picture, the following options are available:

Wallpaper: copies the picture into the wall paper image folder. You can use it in the **Wallpaper** menu (**MENU 7-2**); see page 99.

Picture ID: allows you to set the picture as a caller image for a Phone book entry.

Erase: allows you to erase the selected picture or all of the pictures from Photo Wallet.

Settings

MENU 0-4

This menu allows you to set up the options for using the camera and pictures.

Security (MENU 0-4-1)

You can lock the pictures so that a person without your approval cannot review them.

To access the **Security** menu, you need to enter the lock code. It is preset to "0000" at the factory.

Select **On** and press the **OK** key. Once you have locked the pictures, you need to enter the lock code each time you access the **Photo Album** and **Photo Wallet** menus.

To deactivate this feature, select **Off**.

Quality (MENU 0-4-2)

You can set the default image quality to either **Economy**, **Normal** or **Fine**.

WAP

About the Wap Browser

Your phone comes equipped with a web browser which makes it possible for you to access the wireless web.

The wap browser allows you to access up-to-the minute information through your phone. Browsing the wireless web through your phone is unlike using your computer; site providers have selected only the critical aspects of their sites to present to wireless phone users and they have removed most of the graphics.

Each time you start the wap browser, the phone will connect to the wireless web and the Service icon (📶) will appear on the display. Any time this icon is visible on the display, you are connected to the wireless web and will be billed accordingly. Rates will vary according to your service plan.

The wap browser will end the connection after a certain period of network inactivity and will automatically reconnect as necessary. For this reason, you may find that you are billed for several network connections within a single session. This is normal and is designed to minimise your bill.

You can quickly launch the wap browser by pressing and holding  key in the standby mode.

Launch Wap

 -1

Note: The first time you use the wap browser, you will go through a security setup process that takes 3 to 5 minutes. Please follow the on-screen prompts to complete the security setup process. This initial setup process occurs only the first time you access the service.

1. Accessing the **Launch Wap** menu connects your phone to the wireless web.
2. Once you are connected, the home page or the last page you visited displays.

The opening page contents may be different according to your wireless web service provider.

3. To scroll through the screen, use the  or  key.

Exiting the Wap Browser

To exit the wap browser, simply press the  key at any time.

Using the Wap Browser Soft Keys

At the bottom of the web browser display is a solid bar which contains browser commands. The ◀ and ▶ keys are used to execute the commands. These two keys are called soft keys because their functions change depending on where you are in the wap browser software.

Navigating the Wap Browser

When you use the wap browser, some keys on your phone operate differently than when on a normal phone call.

Here's how the keys work in the Wap Browser:



Navigation keys: Use these keys to scroll to and select browser options. The currently selected option is indicated by an arrow. You can also use them to move the cursor when entering text.



Left and right soft keys: These are the soft keys used to execute the commands at the bottom of the browser display.



MENU key: This key is used for secondary options or a menu of secondary options.



OK key: This key is used for selecting the highlighted item.



* **and # key:** These keys are used to move the cursor to the left or right when entering text.



END key: This key ends the wap browser connection and returns the phone to Standby mode.



Clear key: This key performs two functions:

- Sends you back in the browser. Pressing it once sends you back one page. Pressing and holding this key sends you back to the home page.
- Clears out the entered text or numbers. When entering characters, press this key to clear the last number, letter or symbol. Press and hold this key to completely clear the input field.



Numbered keys 0 - 9: If the items on a page are numbered, you can use these keys to select them.



Volume keys: These keys allows you to scroll up or down by a page or change the volume setting.

Using the Wap Browser Menus

On the wap browser, you can access the following options by pressing and holding the **MENU** key:

Reload: reloads the current wap page.

Home: takes you back at any time to the homepage of the wireless web service provider.

Bookmarks: allows you to directly load a bookmarked wap page.

Mark Site: allows you to set a bookmark for most pages; they can be accessed directly from any web page. Bookmarks save you time by reducing the number of steps required to access a given page.

About Openwave: provides you with information about Openwave and your version of the web browser.

Advanced: gives you access to the following advanced features:

- Show URL: displays the URL address of the site where you are currently connected. It also enables you to declare the current site as the startup homepage.
- Homepage: allows you to change the startup homepage manually.
- Set WAP Proxy: allows you to configure the proxy settings required for connecting to the wireless web.
- Offline Services: Most applications are stored on a server that cannot be accessed outside your wireless coverage area. However, some applications can be stored in the cache of your phone, enabling you to use them offline. You can remove the associated site from the cache at any time.
- Outbox: stores outgoing requests from the browser so that they can be processed at a later date.
- Restart Browser: restarts the browser without exiting it.
- Encryption: This option is automatically set by the service provider. You do not need to change it.

Entering Text in the Wap Browser

When prompted, you can enter letters, numbers or symbols same way as in the phone mode. See page 41 for further details about how to enter characters.

Health and Safety Information

Exposure to Radio-Frequency Energy (SAR Information)

This phone meets Australian Communications Authority (ACA) requirements (AS/NZS 2772) concerning exposure to radio waves.

Your mobile phone is a radio transmitter and receiver. It is designed and manufactured, so as not to exceed the limits for exposure to radio-frequency (RF) energy, as recommended by ACA. These limits are part of comprehensive guidelines and establish permitted levels of RF energy for the general population. The guidelines were developed by independent scientific organisations through periodic and thorough evaluation of scientific studies. The limits include a substantial safety margin designed to ensure the safety of all persons, regardless of age and health.

The exposure standard for mobile phones employs a unit of measurement known as SAR (Specific Absorption Rate). The SAR limit recommended by ACA is 1.6W/kg*.

* The SAR limit for mobile phones used by the public is 1.6 watts/kilogram (W/kg) averaged over one gram of body tissue. The limit incorporates a substantial margin of safety to give additional protection for the public and to account for any variations in measurements. The SAR values may vary depending on the national reporting requirements and the network band.

Precautions When Using Batteries

- Never use any charger or battery that is damaged in any way.
- Use the battery only for its intended purpose.
- If you use the phone near the network's base station, it uses less power; talk and standby time are greatly affected by the signal strength on the cellular network and the parameters set by the network operator.
- Battery charging time depends on the remaining battery charge and the type of battery and charger used. The battery can be charged and discharged hundreds of times, but it will gradually wear out. When the operation time (talk time and standby time) is noticeably shorter than normal, it is time to buy a new battery.
- If left unused, a fully charged battery will discharge itself over time.
- Use only Samsung-approved batteries and recharge your battery only with Samsung-approved chargers. When a charger is not in use, disconnect it from the power source. Do not leave the battery connected to a charger for more than a week, since overcharging may shorten its life.
- Extreme temperatures will affect the charging capacity of your battery: it may require cooling or warming first.

- Do not leave the battery in hot or cold places, such as in a car in summer or winter conditions, as you will reduce the capacity and lifetime of the battery. Always try to keep the battery at room temperature. A phone with a hot or cold battery may temporarily not work, even when the battery is fully charged. Li-Ion batteries are particularly affected by temperatures below 0 °C (32 °F).
- Do not short-circuit the battery. Accidental short-circuiting can occur when a metallic object (coin, clip or pen) causes a direct connection between the + and – terminals of the battery (metal strips on the battery), for example when you carry a spare battery in a pocket or bag. Short-circuiting the terminals may damage the battery or the object causing the short-circuiting.
- Dispose of used batteries in accordance with local regulations. Always recycle. Do not dispose of batteries in a fire.

Road Safety

Your wireless phone gives you the powerful ability to communicate by voice, almost anywhere, anytime. But an important responsibility accompanies the benefits of wireless phones, one that every user must uphold.

When driving a car, driving is your first responsibility. When using your wireless phone behind the wheel of a car, make sure that you are following the special regulations in a given area or country.

Operating Environment

Remember to follow any special regulations in force in any area and always switch off your phone whenever it is forbidden to use it, or when it may cause interference or danger.

When connecting the phone or any accessory to another device, read its user's guide for detailed safety instructions. Do not connect incompatible products.

As with other mobile radio transmitting equipment, users are advised that for the satisfactory operation of the equipment and for the safety of personnel, it is recommended that the equipment should only be used in the normal operating position (held to your ear with the antenna pointing over your shoulder).

Electronic Devices

Most modern electronic equipment is shielded from radio frequency (RF) signals. However, certain electronic equipment may not be shielded against the RF signals from your wireless phone. Consult the manufacturer to discuss alternatives.

Pacemakers

Pacemaker manufacturers recommend that a minimum distance of 15 cm (6 inches) be maintained between a wireless phone and a pacemaker to avoid potential interference with the pacemaker. These recommendations are consistent with the independent research and recommendations of Wireless Technology Research.

Persons with pacemakers:

- Should always keep the phone more than 15 cm (6 inches) from their pacemaker when the phone is switched on
- Should not carry the phone in a breast pocket
- Should use the ear opposite the pacemaker to minimise potential interference

If you have any reason to suspect that interference is taking place, switch off your phone immediately.

Hearing Aids

Some digital wireless phones may interfere with some hearing aids. In the event of such interference, you may wish to consult your hearing aid manufacturer to discuss alternatives.

Other Medical Devices

If you use any other personal medical devices, consult the manufacturer of your device to determine if it is adequately shielded from external RF energy. Your physician may be able to assist you in obtaining this information. Switch off your phone in health care facilities when any regulations posted in these areas instruct you to do so. Hospitals or health care facilities may be using equipment that could be sensitive to external RF energy.

Vehicles

RF signals may affect improperly installed or inadequately shielded electronic systems in motor vehicles. Check with the manufacturer or its representative regarding your vehicle. You should also consult the manufacturer of any equipment that has been added to your vehicle.

Posted Facilities

Switch off your phone in any facility where posted notices require you to do so.

Potentially Explosive Environment

Switch off your phone when in any area with a potentially explosive atmosphere and obey all signs and instructions. Sparks in such areas could cause an explosion or fire resulting in bodily injury or even death.

Users are advised to switch off the phone while at a refuelling point (service station). Users are reminded of the need to observe restrictions on the use of radio equipment in fuel depots (fuel storage and distribution areas), chemical plants or where blasting operations are in progress.

Areas with a potentially explosive atmosphere are often but not always clearly marked. They include below deck on boats, chemical transfer or storage facilities, vehicles using liquefied petroleum gas (such as propane or butane), areas where the air contains chemicals or particles, such as grain, dust or metal powders, and any other area where you would normally be advised to turn off your vehicle.

Emergency Calls

This phone, like any wireless phone, operates using radio signals, wireless and landline networks as well as user-programmed functions, which cannot guarantee connection in all conditions. Therefore, you should never rely solely on any wireless phone for essential communications (medical emergencies, for example).

Remember, to make or receive any calls the phone must be switched on and in a service area with adequate signal strength. Emergency calls may not be possible on all wireless phone networks or when certain network services and/or phone features are in use. Check with local service providers.

To make an emergency call, proceed as follows.

1. If the phone is not on, switch it on.
2. Key in the emergency number for your present location (for example, 111 or any other official emergency number). Emergency numbers vary by location.
3. Press the  key.

If certain features are in use (call barring, for example), you may first need to deactivate those features before you can make an emergency call. Consult this document and your local cellular service provider.

When making an emergency call, remember to give all the necessary information as accurately as possible. Remember that your phone may be the only means of communication at the scene of an accident; do not cut off the call until given permission to do so.

Other Important Safety Information

- Only qualified personnel should service the phone or install the phone in a vehicle. Faulty installation or service may be dangerous and may invalidate any warranty applicable to the device.
- Check regularly that all wireless phone equipment in your vehicle is mounted and operating properly.
- Do not store or carry flammable liquids, gases or explosive materials in the same compartment as the phone, its parts or accessories.
- For vehicles equipped with an air bag, remember that an air bag inflates with great force. Do not place objects, including both installed or portable wireless equipment in the area over the air bag or in the air bag deployment area. If wireless equipment is improperly installed and the air bag inflates, serious injury could result.
- Switch off your phone before boarding an aircraft. The use of wireless phones in an aircraft may be dangerous to the operation of the aircraft, and is illegal.
- Failure to observe these instructions may lead to the suspension or denial of telephone services to the offender, or legal action, or both.

Care and Maintenance

Your phone is a product of superior design and craftsmanship and should be treated with care. The suggestions below will help you fulfill any warranty obligations and allow you to enjoy this product for many years.

- Keep the phone and all its parts and accessories out of the reach of small children.
- Keep the phone dry. Precipitation, humidity and liquids contain minerals that will corrode electronic circuits.
- Do not touch the phone with a wet hand while it is charging. Doing so may cause an electric shock to you or damage to the phone.
- Do not use or store the phone in dusty, dirty areas, as its moving parts may be damaged.
- Do not store the phone in hot areas. High temperatures can shorten the life of electronic devices, damage batteries, and warp or melt certain plastics.
- Do not store the phone in cold areas. When the phone warms up to its normal operating temperature, moisture can form inside the phone, which may damage the phone's electronic circuit boards.

- Do not drop, knock or shake the phone. Rough handling can break internal circuit boards.
- Do not use harsh chemicals, cleaning solvents or strong detergents to clean the phone. Wipe it with a soft cloth slightly dampened in a mild soap-and-water solution.
- Do not paint it. Paint can clog the device's moving parts and prevent proper operation.
- Do not put the phone in or on heating devices, such as a microwave oven, a stove or a radiator. The phone may explode when overheated.
- Use only the supplied or an approved replacement antenna. Unauthorized antennas or modified accessories may damage the phone and violate regulations governing radio devices.
- If the phone, battery, charger or any accessory is not working properly, take it to your nearest qualified service facility. The personnel there will assist you, and if necessary, arrange for service.

Glossary

Airtime - Actual time spent talking on the wireless phone. Most carriers bill customers based on how many minutes of airtime they use each month.

Antenna - A device for transmitting or receiving signals. The size and shape of antennas is determined, in part, by the frequency of the signal they receive. Wireless phones and the base station must have antennas.

Base Station - The fixed radio transmitter/receiver that maintains communications with mobile radio telephones within a given area. (Typically called a cell or cell site)

CDMA - (Code Division Multiple Access) A spread-spectrum approach to digital transmission. With CDMA, each conversation is digitized and then tagged with a code. The mobile phone deciphers only a particular code to pick the right conversation off the air. The transmitted signal is just above noise level across the available bandwidth.

Channel - Communications signals transmit along paths called channels.

Codec - Compression & Decompression.

Deactivation - The process of rendering a wireless phone inactive.

DTMF - (Dual-tone Multi-Frequency) You send DTMF signals when you enter numbers by pressing the digit keys.

EVRC - (Enhanced Variable Rate Codec) EVRC is a new global standard for compressing and decompressing voice signals. EVRC uses a lower bit rate (the number of bits sent per second) than existing CDMA vocoders, while providing significant improvements in voice quality. This technology enables your phone to provide superb voice quality while benefiting from the ability to process more cellular voice calls using less bandwidth than the voice codecs in CDMA networks today.

Frequency - A measure based on time, as one or more waves per second, in an electrical or light wave information signal. A signal's frequency is stated in cycles-per-second or Hertz (Hz).

Hands-Free - A feature that permits a driver to use a wireless phone without lifting or holding the handset - an important safety feature for automobiles, tractors and most other motorized vehicles.

LCD - (Liquid Crystal Display) Commonly used to refer to the screen display on the wireless phone.

LED - (Light Emitting Diode) Commonly used to refer to a small light on the wireless phone or on the Desktop Charger. The LED lights on the phone to indicate an incoming call. The lights on the charger indicate that battery charging is taking place.

Prepend - The addition of a prefix, such as an area code, to a phone number.

RF - Radio Frequency

Roaming - The ability to use a wireless phone to make and receive calls in places outside of the home service area.

Service Charge - The amount paid each month to receive wireless service.

Standby Time - The amount of time a fully charged wireless portable or transportable phone can be on and idle without recharging the battery. (See Talk Time)

Talk Time - The length of time a person can talk on a portable or transportable wireless phone without recharging the battery.

Vocoder - Voice Coder. A device used to convert speech into digital signals.

Wireless - Radio-based Systems that allow transmission of telephone or data signals through the air without a physical connection, such as a metal wire (copper) or fiber optic cable.

Index

A

- Accessories • 9
- Air time • 56
- Alarm • 84
- Alerts • 96
- Alphabet mode, text • 45
- Auto answer • 108
- Auto retry • 109

B

- Backlight • 15, 100
- Banner • 100
- Battery
 - charging • 18
 - installing • 16
 - low battery indicator • 20
 - precautions • 131
 - removing • 17

C

- Calculator • 85
- Calendar, schedule • 79
- Call Answer • 108
- Calls
 - answering • 35
 - outgoing • 53
 - emergency • 25, 114
 - making • 24
 - missed • 38, 55
 - options • 36
 - Incoming • 54
 - restriction • 114
 - three-way • 40
 - time • 56
 - waiting • 39
- Caller ID • 37
- Canned messages • 76
- Care • 139
- Characters, entering • 41
- Connect alert • 92
- Countdown timer • 87

D

- Data/fax
 - receiving • 111
 - sending • 111
- Daylight saving time (DST),
 - setting • 101
- Dialed calls • 53
- Dialing
 - pause • 30
 - prepend • 27
 - speed • 28
- Disconnect alert • 96
- Display
 - icons • 13
 - layout • 11
 - banner • 100
- Dual clock
 - setting • 101
 - wallpaper • 99

E

- Emergency call • 25, 114
- English T9 mode, text • 41
- Erasing History • 55
- Erase Msg • 74
- Escalating • 98

F

- Fade alert • 96
- Filed messages • 66
- Four-digit dialing • 30

G

- Games • 103
- Greeting
 - voice answer • 91
- Group, phonebook
 - finding • 57
 - setting • 62

I

- Icon description • 13
- Inbox, messages • 67
- Installing battery • 16
- Incoming calls • 54

K

- Keys
 - description • 12
- Key tone
 - setting • 97

L

- Last number redialing • 26
- Letters, entering • 41
- Lock code, changing • 114
- Lock mode, setting • 113
- Low battery indicator • 20

M

- Maintenance • 139
- Memo pad • 83
- Menu style, changing • 99
- Menus
 - list • 50
 - scrolling • 48
 - shortcuts • 49
- Message
 - setup • 75
 - text • 65
 - see text message • 67
 - voice, listening • 74
- Minute beep • 96
- Missed calls • 55
- MMS
 - inbox • 71
 - outbox • 72
 - draftbox • 73
 - alert • 73

N

- Names
 - finding • 57
 - saving • 59
- Number
 - correcting • 25
 - finding • 57
 - saving • 59

O

- Outbox, messages • 68
- Outgoing calls • 53

P

- Pause dialing • 30
- Phone
 - layout • 10
 - locking • 113
 - modes • 21
 - resetting • 115
- Phonebook
 - adding entries • 59
 - finding • 57
 - group, setting • 62
 - memory status • 63
- Photo
 - taking a picture • 116
 - photo album • 120
 - photo wallet • 122
- Power save mode • 22
- Power saving • 102
- Prepend dialing • 27

R

Received calls • 54
 Received messages • 67
 Recording
 greeting • 92
 voice memo • 89
 Reset, phone • 115
 Restriction, calls • 114
 Retry
 auto • 109
 last number • 26
 Ringer
 type • 95
 volume • 94
 Roaming • 110
 Roam ringer • 97

S

Safety information • 7, 130
 Scheduler • 79
 Security • 113
 Service alert • 96
 Service light • 15, 102
 Silent mode • 22
 Speed dialing • 28
 Standby mode • 21
 Symbol mode, text • 47

T

Task list • 81
 Talk mode • 22
 Text, entering • 41
 Text input mode, changing • 42
 Text message
 filed • 69
 inbox • 67
 outbox • 68
 sending • 65
 alert • 70

Three-way calling • 40
 Time, setting • 88
 Today, schedule • 77











V

Version, checking • 112
 Voice answer
 caller, listening • 91
 greeting, recording • 92
 Voice memo • 89
 Volume, adjusting
 earpiece • 34
 key tone • 34, 97
 ringer • 95

W

Waiting call • 39
 Wallpaper, image • 99
 Wap browser
 launch web • 125
 World time • 86

BASIC OPERATIONS

Make a call	Phone number + 	Save a Number	Enter Number + OK + OK + ▲ / ▼ to select Label + OK + Enter Name + OK + ▲ / ▼ to select Entry/Home/Work/Mobile /Pager/Fax/No label/Speed dial/ Email/URL/Group/Name Ringer/Birthday/Secret/Image) + ▲ / ▼ to change the settings or MENU to enter information + OK + OK
End a call		Speed dialing	Enter Memory Location of the number you want, holding the last digit to automatically dial.
Receive a call		Phonebook Search	Press ▲ + ▼ / ▲ + ▼ /  + OK or 
Adjust the key beep volume	(In Standby mode) 	Launch the web browser	Press and hold 
Adjust the speaker volume	(during a conversation) 		
Redial the last call	 twice or hold 		
Switch to Silent mode	Press and hold #		



Man Menu (To access, press the **MENU** key)

1: Calls	1: Outgoing 2: Incoming 3: Missed 4: Erase History 5: Air Time	6: Sounds	1: Ringer Volume 2: Ringer Type 3: Alerts 4: Key tone 5: Ream Ringer 6: Power On/Off 7: Escalating
2: Phone Book	1: Find 2: Add New Entry 3: Group Setting 4: My Phone # 5: Memory	7: Display	1: Menu Style 2: Wallpaper 3: Backlight 4: Brightness 5: Panel Clock 6: Service LED 7: Contrast 8: Power-Saving
3: Messages	1: Text 2: Photo 3: Voice 4: Erase MSG 5: MSG Setting	8: Games	1: Fun Bowling 2: Honey Ball 3: Go Hamster
4: Planner	1: Today 2: Scheduler 3: Task List 4: Memo Pad 5: Alarm 6: Calculator 7: World Time 8: Countdown 9: Set Time	9: Setup	1: Auto Answer 2: Call Answer 3: Auto Key Lock 4: Auto Priority 5: Set System 6: Data/fax 7: Version 8: Security
5: Voice Tools	1: Voice Memo 2: Voice Answer	0: Photos	1: Take Picture 2: Photo Album 3: Photo Wallet 4: Settings

Licensed by QUALCOMM Incorporated under one or more of the following Patents.

U.S Patent No. 4,901,307 5,056,109 5,099,204
5,101,501 5,103,459 5,107,225
5,109,390