

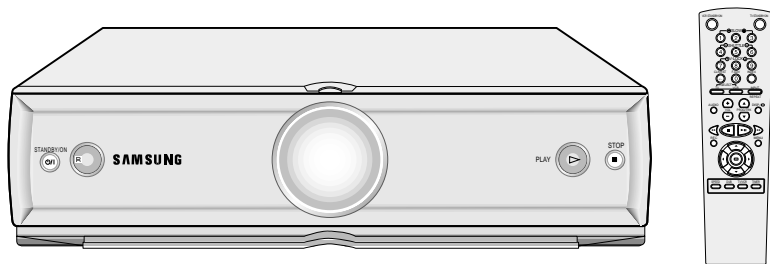



VIDEO CASSETTE RECORDER

SV-647B

Instruction Manual



Safety Precautions



CAUTION

RISK OF ELECTRIC SHOCK
DO NOT OPEN



CAUTION. TO REDUCE THE RISK OF ELECTRIC SHOCK, DO NOT REMOVE REAR COVER. NO USER SERVICEABLE PARTS INSIDE. REFER TO QUALIFIED SERVICE PERSONNEL.



DANGER

This symbol is intended to alert you to the presence of dangerous voltage within the product.

IMPORTANT NOTE

The mains lead on this equipment is supplied with a moulded plug incorporating a fuse. The value of the fuse is indicated on the pin face of the plug. If it requires replacing, a fuse approved to BS1362 of the same rating must be used.

Never use the plug with the fuse cover omitted if the cover is detachable. If a replacement fuse cover is required, it must be of the same colour as the pin face of the plug. Replacement covers are available from your dealer.

If the fitted plug is not suitable for the power points in your house or the cable is not long enough to reach a power point, you should obtain a suitable safety approved extension lead or consult your dealer for assistance.

However, if there is no alternative to cutting off the plug, remove the fuse and then safely dispose of the plug. Do not connect the plug to a mains socket, as there is a risk of shock hazard from the bared flexible cord.

IMPORTANT

The wires in the mains lead are coloured in accordance with the following code: -

BLUE = NEUTRAL BROWN = LIVE

As these colours may not correspond with the coloured markings identifying the terminals in your plug, proceed as follows: -

The wire coloured BLUE must be connected to the terminal marked with the letter N or coloured BLUE or BLACK. The wire coloured BROWN must be connected to the terminal marked with the letter L or coloured BROWN or RED.

WARNING: DO NOT CONNECT EITHER WIRE TO THE EARTH TERMINAL WHICH IS MARKED WITH THE LETTER E OR BY THE EARTH SYMBOL , OR COLOURED GREEN OR GREEN AND YELLOW.



CAUTION

This symbol is intended to alert you to the presence of important instructions accompanying the product.

Contents

- ◆ FOREWORD
 - Safety Instructions..... 5
- ◆ VCR OVERVIEWS
 - Front View of the VCR..... 6
 - Rear View of the VCR 6
 - Infrared Remote Control..... 7
 - Display Indicators 8
 - Accessories 8
- ◆ CONNECTING YOUR VIDEO CASSETTE RECORDER
 - Deciding How to Connect Your VCR..... 9
 - Connecting Your VCR to the TV using the Coaxial Cable and SCART cable..... 10
 - Connecting Your VCR to the Satellite receiver or Other Equipment 11
 - Connecting the Audio Output Cable..... 12
 - Plug & Auto Set Up..... 12
 - Tuning Your Television for the VCR 13
- ◆ SETTING UP YOUR VIDEO CASSETTE RECORDER
 - Inserting Batteries in the Remote Control..... 14
 - Setting the Date and Time..... 14
 - Displaying/Hiding On-Screen Information 15
 - Setting the VCR Output Channel..... 15
 - Presetting the Stations Automatically 16
 - Presetting the Stations Manually 17
 - Clearing a Preset Station..... 18
 - Changing the Preset Station Table..... 19
- ◆ RECORDING TELEVISION BROADCASTS
 - Selecting the Cassette Type..... 20
 - Selecting the Recording Speed..... 20
 - NICAM 21
 - Protecting a Recorded Cassette 22
 - Recording a Programme Immediately..... 22
 - Recording a Programme with Automatic Stop..... 23
 - Using the VIDEOPLUS+ Feature 24
 - Modifying VIDEOPLUS+ Programming 25
 - Using the Timer Programming Feature 26
 - Checking a Preset Recording..... 27
 - Cancelling a Preset Recording..... 27
- ◆ PLAYING BACK
 - Playing a Cassette..... 28
 - Adjusting Picture Alignment Manually 28
 - Intelligent Picture Control 29
 - Format 16:9 (Wide Screen) 30
 - Selecting the Colour Mode 30
 - Selecting the Audio Output Mode..... 31

Contents (cont.)

GB

- ◆ SEARCHING FOR A SEQUENCE
 - Playing a Cassette in Slow Motion 32
 - Playing a Sequence Frame by Frame 33
 - Picture Search, Fast Forward/Rewind 33
 - Searching for a Specific Sequence 34
 - Auto Repeat Play 35
 - Interval Repeat Play 35

- ◆ INFO TAG FUNCTION
 - Info Tag (Information Tag) Function 36
 - Searching using the Info Tag (Information Tag) Function 37
 - Presetting the title 37
 - Deleting the Info Tag 38

- ◆ EASY OPERATION
 - VPS/PDC Default 39
 - VIDEOPLUS+ EXTEND 40
 - Using the Tape Counter 40

- ◆ AV-LINK FUNCTION OF THIS VCR
 - AV-Link Function of this VCR 41
 - TV Programme Download 42
 - Direct Record (Setting) 43
 - Direct Record (Procedure) 43
 - Pictures and TV Picture Recording 44

- ◆ ADVANCED RECORDING FEATURES
 - Connecting an RCA Audio/Video Input Cable 45
 - Using the Assemble Edit Function 46
 - Recording from Another VCR or Camcorder 46
 - Audio Dubbing a Pre-recorded Cassette 47

- ◆ OTHER FUNCTIONS AND USEFUL RECOMMENDATIONS
 - Using the TV Buttons on the Remote Control 48
 - Auto Power Off 49
 - ECO Mode-Reducing Standby power consumption 49
 - Technical Specifications 50

- ◆ SOLVING PROBLEMS
 - Problems and Solutions 51
 - Service Centers List 52

Symbols



Press/push



Hold down



Important



Note

① = Step number

Safety Instructions

GB

The following illustrations represent precautions.



The lightning bolt is a warning sign alerting you to dangerous voltage inside the product. DO NOT OPEN THE VCR. Refer to service personnel.

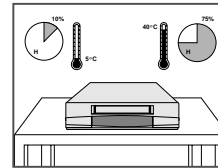

Do NOT expose the VCR to extreme temperature conditions (below 5°C and above 40°C) or to extreme humidity conditions (less than 10% and more than 75%).

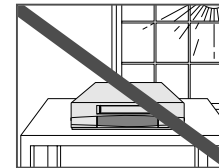

Do NOT expose the VCR to direct sunlight.

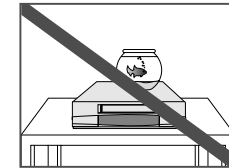

Do NOT expose the VCR to any liquids.

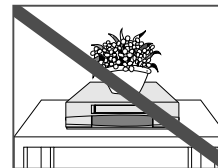

Do NOT place any objects on the VCR or remote control.

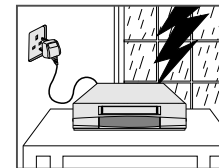

During a storm and/or lightning, unplug the VCR from the mains socket and aerial.

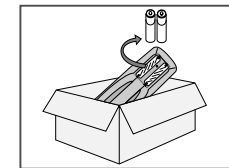

If the remote control is not used for a long period of time, remove the batteries and store it in a cool, dry place.

THIS DEVICE IS NOT FOR USE IN INDUSTRIAL ENVIRONMENTS

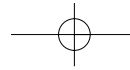

Front View of the VCR

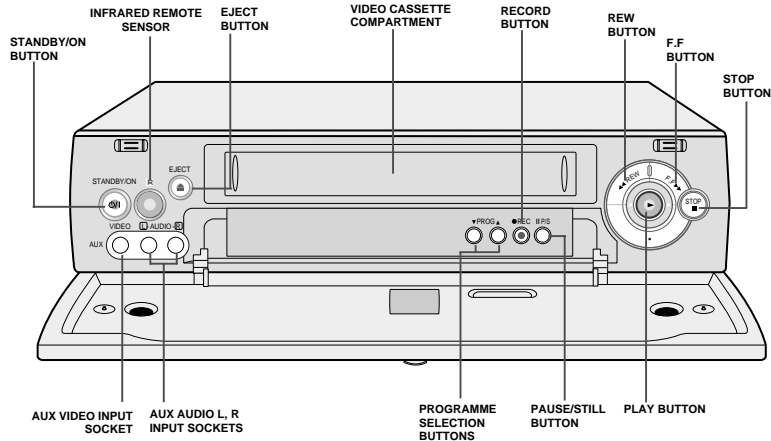

Infrared Remote Control

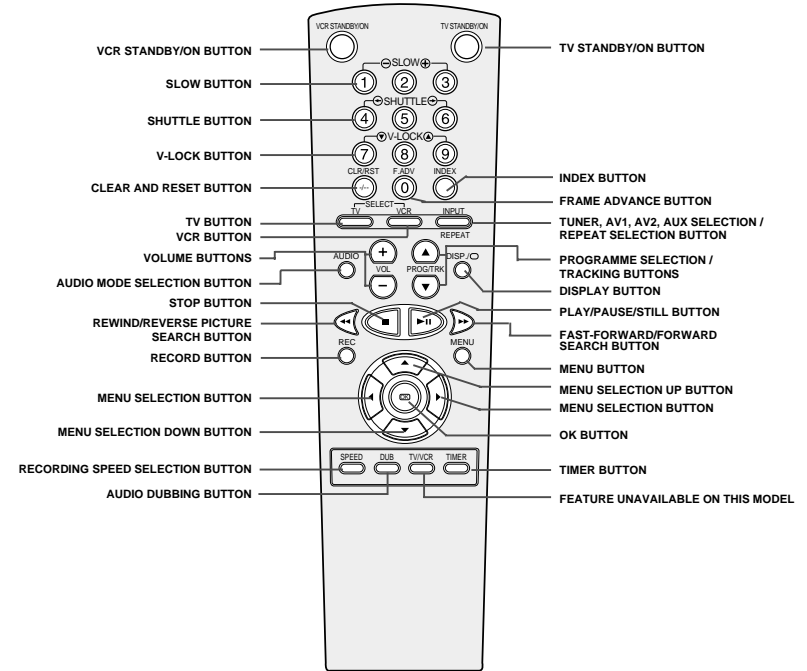

Rear View of the VCR

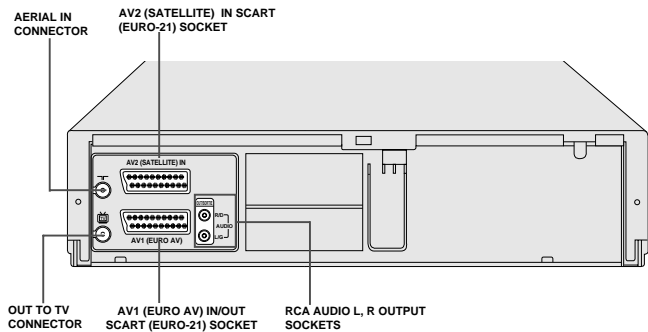

Display Indicators

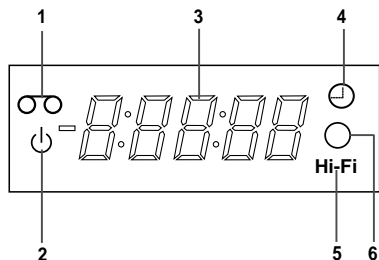

- 1 Cassette loaded indicator
- 2 ECO Mode display
- 3 Multi-function display
- 4 Timer indicator
- 5 Hi-Fi indicator
- 6 Rec indicator

Accessories

You have just purchased a SAMSUNG Video Cassette Recorder (VCR). Together with your VCR, you will find the following accessories in the box.

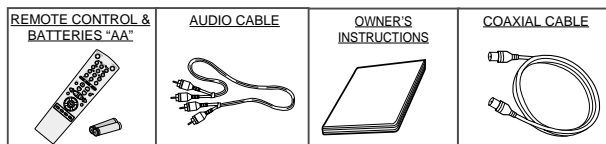













Deciding How to Connect Your VCR

You must take into account various factors when connecting audio or video systems:

- ◆ Types of connectors available on your systems
- ◆ Systems connected permanently to the VCR (satellite receiver for example) or temporarily (camcorder for example)

Your VCR is equipped with the following connectors.

Connector	Location	Type	Direction	Recommended Use
AV1 (EURO AV)	Rear 	SCART	In/Out 	◆ Television ◆ Satellite receiver ◆ Other VCR
AV2 (DEC./EXT.)	Rear 	SCART	In 	◆ Satellite receiver ◆ Other VCR
AUX	Front 	Audio/Video RCA	In 	◆ Audio Hi-Fi system ◆ Camcorder ◆ Hi-Fi Stereo VCR
Audio output	Rear 	Audio RCA	Out 	◆ Audio Hi-Fi system
OUT TO TV	Rear 	75 Ω coaxial	Out 	◆ Television
IN FROM ANT.	Rear 	75 Ω coaxial	In 	◆ Aerial ◆ Cable television network ◆ Satellite receiver



Whenever you connect an audio or video system to your VCR, ensure that all elements are switched off.

Refer to the documentation supplied with your equipment for detailed connection instructions and associated safety precautions.

GB

Connecting Your VCR to the TV using the Coaxial Cable and SCART cable

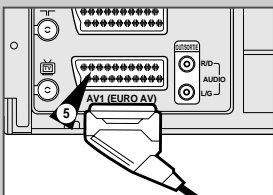
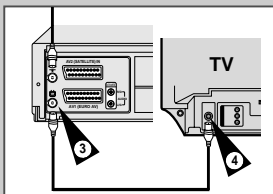
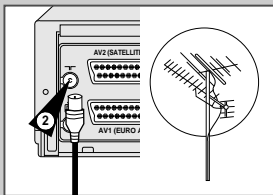

To receive television programmes a signal must be received from one of the following sources:

- ◆ An outdoor aerial
- ◆ An indoor aerial
- ◆ A cable television network
- ◆ A satellite receiver

Make sure that both the television and the VCR are switched off before connecting the cables.

- 1 Remove the aerial or network input cable from the television.
- 2 Connect this cable to the 75Ω coaxial socket marked \square on the rear of your VCR.
- 3 Plug the coaxial cable supplied into the  socket on your VCR.
- 4 Plug the other end of the coaxial cable into the connector previously used for the aerial on the television.
- 5 Connect one end of the scart cable to the AV1 (EURO AV) socket on the rear of the VCR. You must connect your VCR to the television via the scart cable.
- 6 Plug the other end into the appropriate connector on the television.

Connecting Your VCR to the Satellite receiver or Other Equipment

GB

You can connect your VCR to a Satellite receiver or other VCR using the SCART cable if the appropriate outputs are available on the equipment chosen. The following illustrations give a few examples of the connection possibilities.

1. AV2(DEC./EXT.): By means of 21-pin Scart Cable

Plug the SCART Cable with satellite receiver or other equipment into the AV2(DEC./EXT.) socket on the rear of the VCR.

After making this connection, select the source by pressing the INPUT button for the AV2 input sources.

2. By means of RF Coaxial Cable

After making this connection, you must preset the station received through the satellite tuner.

RF output channel of the satellite receiver should be adjusted away from channel 60, which is used by the VCR, e.g. re-adjust to channel 65.

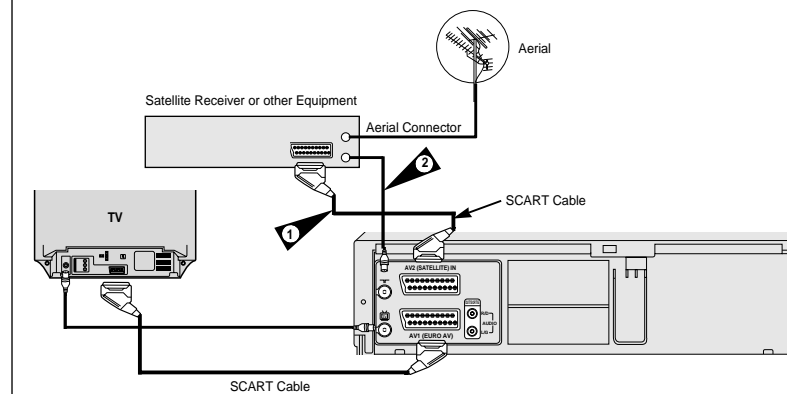

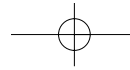

Connecting the Audio Output Cable

GB

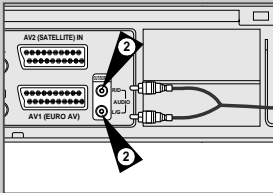
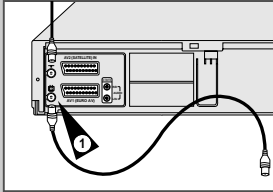

You can connect your VCR to a Hi-Fi system.

Example: You wish to take advantage of the quality of your Hi-Fi stereo system when watching a programme or recording via your VCR.

- ◆ Regardless of the type of connection chosen, you must always connect the coaxial cable supplied. Otherwise, no picture will be visible on the screen when the VCR is switched off.
- ◆ Make sure that both the television and the VCR are switched off before connecting the cables.

- 1 Connect the coaxial cable or SCART as indicated on page 10.
- 2 Plug the audio output cable into the audio connectors on the rear of your VCR.
 - Respect the colour coding of the left and right channels.
- 3 Plug the other end of the audio cable into the appropriate input connectors on your Hi-Fi stereo system.

Plug & Auto Set Up

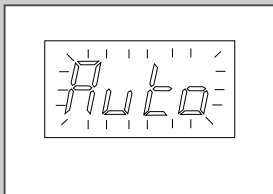
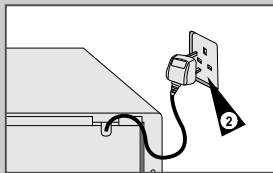
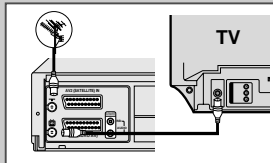

Your VCR will automatically set itself up when it is plugged into the mains for the first time. TV stations will be stored in memory. The process takes a few minutes. Your VCR will then be ready for use.

- 1 Connect the coaxial cable as indicated on page 10. (Connecting Your VCR to the TV Using the Coaxial Cable)
- 2 Plug the VCR into the mains.

Result: A message appears.
- 3 The PLEASE WAIT indication flashes on the television screen.
 - ◆ The number of stations automatically stored by the VCR depends on the number of stations that it has found.
 - ◆ The process will finish after a few minutes.
- 4 The current time and date are displayed automatically. Check the date and time.

if it is :

 - ◆ Correct, Press MENU button twice to exit the menu.
 - ◆ incorrect, see page 14.

➤ Now, you only have to switch the VCR on and it is ready for use.

✎ Function for "Plug & Auto Set Up" is fixed already. So if you want to change this fixed one, you can change it by Presetting the Stations Automatically in OSD " Auto Set Up" menu. (see page 16)

Tuning Your Television for the VCR

GB

You must tune your television for the VCR only if you are not using a Scart cable

➤ To view pictures from your VCR when a Scart cable is used, the television must be set to the audio/video mode (AV).

- 1 Switch on the television.
- 2 Switch on the VCR by pressing STANDBY/ON on the front of the VCR or VCR STANDBY/ON on the remote control.
- 3 Select a programme position on the television to be reserved for use with your VCR.
- 4 Insert the video cassette in the VCR. Check that the VCR starts reading the cassette; if not, press ►► button.
- 5 Start a scan on your television or set the television to UHF channel 60.
- 6 Fine tune the television until the pictures and sound are obtained clearly.
- 7 If you cannot find the pictures and sound, or there is interference from nearby channels, it may be necessary to change the setting of the VCR output channel (see Setting the VCR Output Channel on page 15 and Problems and Solutions on page 50).
- 8 When the picture and sound are perfectly clear, store this channel at the desired programme position on the television.

Result: That programme is now reserved for use with your VCR.

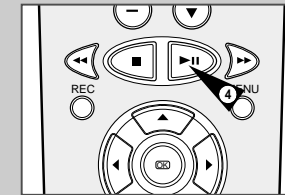
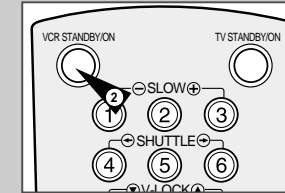

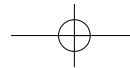

Inserting Batteries in the Remote Control

GB

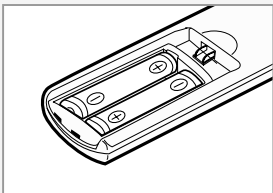
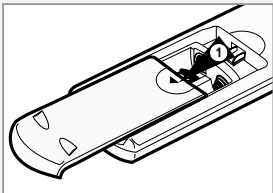

You must insert or replace the batteries in the remote control when you:

- ◆ Purchase the video cassette recorder
- ◆ Find that the remote control is no longer working correctly

- 1 Push the tab in the direction of the arrow to release the battery compartment cover on the rear of the remote control.
- 2 Insert two AA, R6 or equivalent batteries, taking care to respect the polarities:
 - ◆ + on the battery with + on the remote control
 - ◆ - on the battery with - on the remote control
- 3 Replace the cover by aligning it with the base of the remote control and pushing it back into place.

➤ Do not mix different battery types (manganese and alkaline for example).

Setting the Date and Time

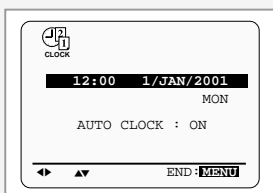
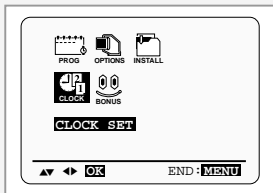
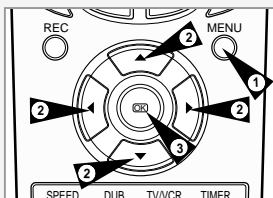

Your VCR contains a 24-hour clock and calendar used to:

- ◆ Automatically stop programme recording
- ◆ Preset your VCR to record a programme automatically

You must set the date and time when:

- ◆ You purchase the video cassette recorder

- ◆ The time and date are set automatically from the broadcast signal. If the signal is weak or ghosting occurs, the time and date may not be set automatically. In this case, they should be set manually.
- ◆ Do not forget to reset the time when you change clocks from winter to summer time and vice versa.

- 1 Press MENU on the remote control.
Result: The programming menu is displayed.
- 2 Press the corresponding ▲, ▼ or ◀, ▶ buttons to select the **CLOCK SET** option.
- 3 Press the OK button to select this option.
Result: The **CLOCK SET** menu is displayed.
- 4 Press ◀ or ▶ to select the hour, minutes, day, month and year.
Result: The option selected flashes.
- 5 Press the ▲ or ▼ buttons to increase or decrease the value.
Result: The day of the week is displayed automatically.
 - You can hold the ▲ or ▼ buttons down to scroll more quickly through the values.
- 6 On completion, press MENU twice to exit the menu.

Displaying/Hiding On-Screen Information

Your VCR displays most information both on the VCR and the television.

You can choose to display or hide this information on the television screen (except for the Index, Programming MENU and VIDEOPLUS+ functions, which cannot be hidden).

- 1 Press MENU on the remote control.
Result: The programming menu is displayed.
- 2 Press the corresponding ▲, ▼ or ◀, ▶ buttons to select the **USER SET** option.
- 3 Press the OK button to select this option.
Result: The **USER SET** menu is displayed.
- 4 Press the corresponding ▲ or ▼ buttons, until the OSD option is selected.
- 5 To... **Press ◀ or ▶, until...**

Display on-screen information	ON is displayed.
Hide on-screen information	OFF is displayed.
- 6 On completion, press MENU twice to exit the menu.

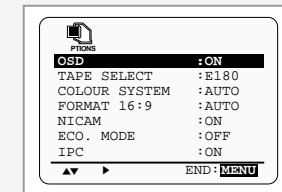
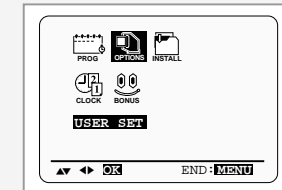

Setting the VCR Output Channel

Your VCR output channel may need to be changed if the pictures suffer from interference or if your TV cannot find the pictures. Also, you can change the VCR output channel to adjust the frequency in which information is displayed on the screen.

- 1 Press MENU on the remote control.
Result: The programming menu is displayed.
- 2 Press the corresponding ▲, ▼ or ◀, ▶ buttons to select the **INSTALLATION** option.
- 3 Press the OK button to select this option.
Result: The **INSTALLATION** menu is displayed.
- 4 Press the corresponding ▲ or ▼ buttons, until the **VCR OUTPUT CH** option is selected.
- 5 Select the required output channel (CH21~CH69) by pressing the ◀ or ▶ buttons.
- 6 On completion, press MENU twice to exit the menu. Then tune your television again (see page 13).

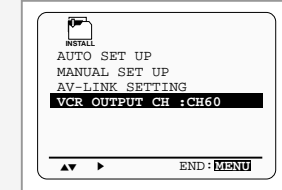
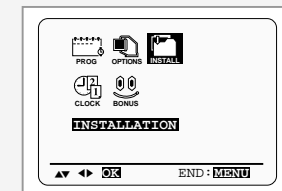

GB

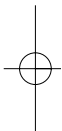

Presetting the Stations Automatically

GB

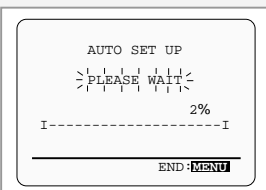
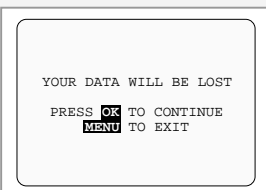
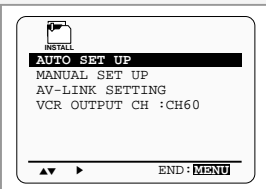
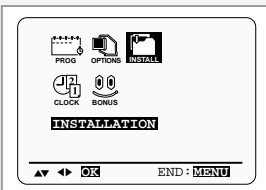

You do not need to preset the stations if you have already set them automatically (see Plug & Auto Set Up on page 12).

Your VCR contains a built-in tuner used to receive television broadcasts.

You must preset the stations received through the tuner. This can be done:

- ◆ Plug & Auto Set up (see page 12)
- ◆ Automatically
- ◆ Manually (see page 17)

You can store up to 80 stations.

- 1 Press the MENU button on the remote control.
Result: The programming menu is displayed.
- 2 Press the corresponding ▲, ▼ or ◀, ▶ buttons to select the **INSTALLATION** option.
- 3 Press the OK button to select this option.
Result: The **INSTALLATION** menu is displayed.
- 4 Press the corresponding ▲ or ▼ buttons, until the **AUTO SET UP** option is selected. And then press the ▶ button to select this option.
Result: A message appears, indicating that any channels already preset on your VCR will be deleted.
- 5 Press OK to start the auto scanning.
Result:
 - ◆ The **PLEASE WAIT** indication flashes on the television screen.
 - ◆ The first frequency band is scanned and the first station found is displayed and stored.
 - ◆ The VCR then searches for the second station and so on.
 - ◆ When the automatic scanning procedure has finished, the VCR switches automatically to programme 1.

➤ The number of stations automatically stored by the VCR depends on the number of stations that it has found.

- 6 If you wish to cancel the auto scanning before the end, press the MENU button three times to exit the menu.

-
- ◆ The time and date are set automatically from the broadcast signal. If the signal is weak or ghosting occurs, the time and date may not be set automatically. In this case, they should be set manually (see page 14).
 - ◆ Once the auto scanning procedure has finished, some stations may have been stored more than once: select the stations with the best reception and delete the ones no longer required (see page 18).

Presetting the Stations Manually

GB

You do not need to preset the stations manually if you have already set them automatically.

- 1 Press the MENU button on the remote control.
Result: The programming menu is displayed.
 - 2 Press the corresponding ▲, ▼ or ◀, ▶ buttons to select the **INSTALLATION** option.
 - 3 Press the OK button to select this option.
Result: The **INSTALLATION** menu is displayed.
 - 4 Press the corresponding ▲ or ▼ buttons, until the **MANUAL SET UP** option is selected.
 - 5 Press the ▶ button to select a **MANUAL SET UP** option.
Result: The **TV STATION TABLE** menu is displayed.
 - 6 Press the ▲ or ▼ buttons to select a programme number as required.
 - 7 Press the ▶ button to preset the station.
Result: The **MANUAL TUNING** menu is displayed.
 - 8 Press the ◀ or ▶ buttons to start scanning.
Result: The frequency band is scanned and the first station found is displayed.
 - 9 Press the ▲ or ▼ buttons until the cursor is placed in front of the **NAME**.
Result: The station name is set automatically from the broadcast signal.
 - 10 To change the programme's name, press the ▶ button.
Result: The first letter of the name flashes.
- | 11 To... | Then... |
|--|--|
| Select a character in the name | Press the ▲ or ▼ button until the required character is displayed (letters, numbers or "-" character). |
| Move to the next or previous character | Press the ▶ or ◀ buttons respectively. |
- 12

If you...	Then...
Wish to store the station displayed	<ul style="list-style-type: none"> ◆ Press the corresponding ▲ or ▼ buttons, until the MFT is selected. ◆ Press the ◀ or ▶ buttons to adjust the picture, if necessary. ◆ Press OK to store the station
Do <u>not</u> wish to store the station displayed	<ul style="list-style-type: none"> ◆ Press the corresponding ▲ or ▼ buttons, until the CH is selected. ◆ Press the ◀ or ▶ buttons to go on scanning the frequency band and display the next station ◆ Go back to the beginning of Step 12
 - 13 Repeat this procedure from Step 6 onwards, until all the required stations have been stored.
 - 14 On completion, press the MENU button three times to exit the menu.

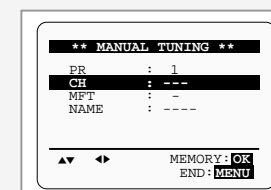
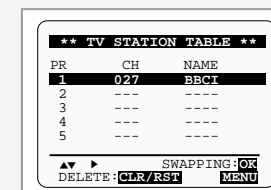
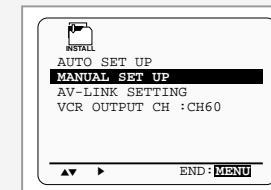
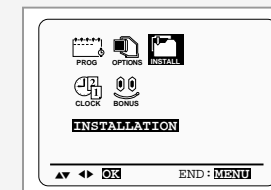

Clearing a Preset Station

GB

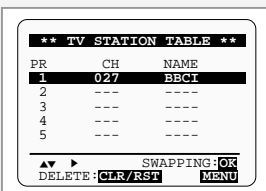
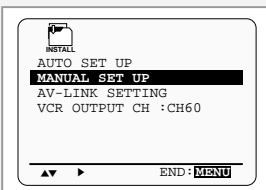
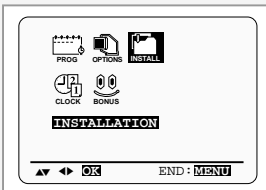

If you have stored a TV station:

- ◆ That you do not require
- ◆ At the wrong programme position

you can cancel it.

- 1 Press the MENU button on the remote control.
- 2 Press the corresponding ▲, ▼ or ◀, ▶ buttons to select the **INSTALLATION** option.
- 3 Press the OK button to select this option.
Result: The **INSTALLATION** menu is displayed.
- 4 Press the corresponding ▲ or ▼ buttons, until the **MANUAL SET UP** option is selected.
- 5 Press the ▶ button to select this option.
Result: The **TV STATION TABLE** menu is displayed.
- 6 Press the corresponding ▲ or ▼ buttons, until the required preset TV station (PR) is selected.
- 7 Press the CLR/RST button.
- 8 Repeat the same procedure from Step 6 onwards until all the required stations have been cleared.
- 9 On completion, press the MENU button three times to exit the menu.

Changing the Preset Station Table

GB

You can rearrange the Station Table and give different programme numbers to the stations listed according to your own preferences.

- 1 Press the MENU button on the remote control.
- 2 Press the corresponding ▲, ▼ or ◀, ▶ buttons to select the **INSTALLATION** option.
- 3 Press the OK button to select this option.
Result: The **INSTALLATION** menu is displayed.
- 4 Press the ▲ or ▼ buttons to select **MANUAL SET UP** option. And then press the ▶ button to select this option.
Result: The **TV STATION TABLE** menu is displayed.
- 5 Press the corresponding ▲ or ▼ buttons, until the required preset TV programme is selected.
Result: The selected station is displayed at the same time on the television screen.
- 6 To change the programme number assigned to a station press the OK button on the remote control. (For example, To move a TV station in programme 1 to programme 3)
- 7 Press the ▲ or ▼ buttons to select required position. And then press OK again to swap the position.
- 8 You can modify this station by repeating the same procedure from Step 5 onwards.
- 9 On completion, press the MENU button three times to exit the menu.

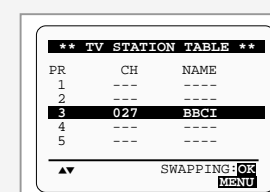
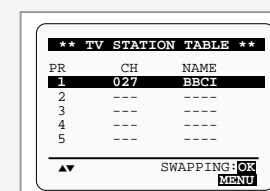
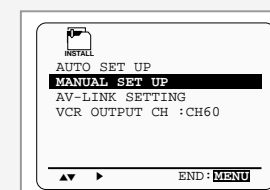
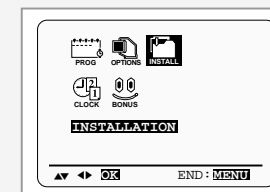

GB

Selecting the Cassette Type

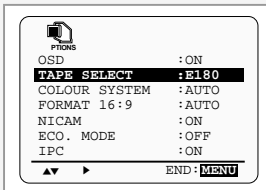
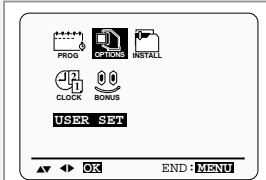

If you wish to use the tape counter to display the time remaining on a cassette, you must indicate the type of cassette inserted.

- Press MENU on the remote control.
Result: The programming menu is displayed.
- Press the corresponding ▲, ▼ or ◀, ▶ buttons to select the **USER SET** option.
- Press the OK button to select this option.
- Press the corresponding ▲ or ▼ buttons, until the **TAPE SELECT** option is selected.
- Press the ◀ or ▶ buttons as many times as required, until the correct cassette length is displayed.

▶	E180	▶	E240
▶	E300	◀	E260
- Press MENU twice to exit the menu.

Selecting the Recording Speed

Type	Recording Time (in SP)
E-180	180 mins. or 3 hours
E-240	240 mins. or 4 hours
E-260	260 mins. or 4 hours and 20 mins.
E-300	300 mins. or 5 hours

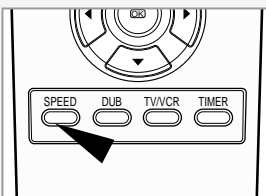

You can record a cassette at two different speeds:

- ◆ *SP (Standard Play)*
- ◆ *LP (Long Play)*

In Long Play modes:

- ◆ *Each cassette lasts twice as long*
- ◆ *The recording is of a slightly lower quality*

To record a cassette... Press the SPEED button on the remote control, until...

- | | |
|-----------------------|------------------|
| In standard play mode | SP is displayed. |
| In long play mode | LP is displayed. |

NICAM

NICAM programmes are divided into 3 types. *NICAM Stereo, NICAM Mono and Bilingual (transmission in another language).* *NICAM programmes are always accompanied by a standard mono sound broadcast and you can select the desired sound.* Please refer to page 31.

- Press MENU on the remote control.
Result: The programming menu is displayed.
- Press the corresponding ▲, ▼ or ◀, ▶ buttons to select the **USER SET** option.
- Press the OK button to select this option.
Result: The **USER SET** menu is displayed.
- Press the corresponding ▲ or ▼ buttons, until the **NICAM** option is selected.
- To... Press ◀ or ▶, until...**

Mono mode	OFF is displayed. OFF: Only set at this position to record the standard mono sound during a NICAM broadcast if the stereo sound is distorted due to inferior reception conditions.
NICAM mode	ON is displayed. ON: Normally set at this position.
- On completion, press MENU twice to exit the menu.

GB

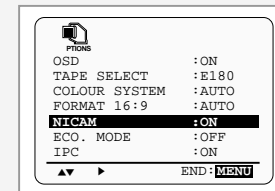
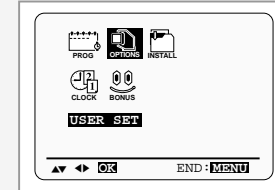

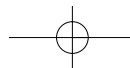

Protecting a Recorded Cassette

GB

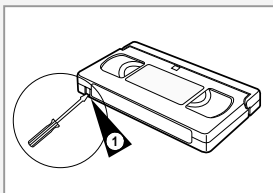

*Video cassettes have a safety tab to prevent accidental erasure. When this tab has been removed, you **cannot** record on the tape.*

- 1 If you wish to protect a cassette, break off the tab using a small screwdriver.
- 2 To re-record over a protected cassette (safety tab broken), cover the hole with adhesive tape.

Recording a Programme Immediately

Before recording a programme, you must have preset the corresponding station (unless you are recording via an external video source). If you have not done so, refer to pages 16 and 17.

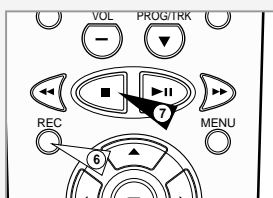
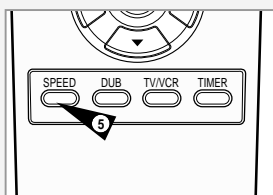
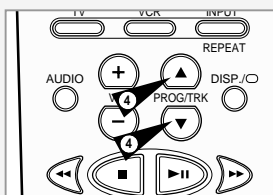

- 1 Switch on the television.
- 2 To monitor the programme being recorded, select the television channel reserved for use with your VCR (or the AV input if used).
- 3 Insert the cassette on which the programme is to be recorded, with the window visible and the safety tab intact or the opening covered with adhesive tape.
Result: The VCR is switched on automatically.
- 4 Select:
 - ◆ The station to be recorded using the PROG/TRK (▲ or ▼) buttons
or
 - ◆ The AV1, AV2 or AUX source using the INPUT button for a satellite tuner or external video source**Result:** The station number is displayed and the programme can be seen on the television.
- 5 Select the recording speed by pressing the SPEED button as many times as required (see page 20).
- 6 Hold REC down for a while to start recording.
Result: The record indicator appears on the television and VCR display. An index is recorded on the tape (see page 34).
- 7 To stop recording, press ■ once.

-
- ◆ If your VCR ejects the cassette when you start recording, check to make sure that the cassette's safety tab is intact or that the opening (created by a broken safety tab) is covered with adhesive tape.
 - ◆ If you reach the end of the tape while recording, the cassette rewinds automatically.

Recording a Programme with Automatic Stop

This function enables you to record up to nine hours (LP) of programmes.

Your VCR stops automatically after the requested length of time.

- 1 Switch on the television.
- 2 To monitor the programme being recorded, select the television channel reserved for use with your VCR (or the AV input if used).
- 3 Insert the cassette on which the programme is to be recorded, with the window visible and the safety tab intact or the opening covered with adhesive tape.
Result: The VCR is switched on automatically.
- 4 Select:
 - ◆ The station to be recorded using the PROG/TRK (▲ or ▼) buttons
or
 - ◆ The AV1, AV2 or AUX source using the INPUT button for a satellite tuner or external video source**Result:** The channel number is displayed and the programme can be seen on the television.
- 5 Select the recording speed by pressing the SPEED button as many times as required (see page 20).
- 6 Hold the REC button down for a while to start recording.
Result: The record indicator appears on the television screen and VCR display. An index is recorded on the tape (see page 34).
- 7 Press the REC button several times to increase the recording time in:
 - ◆ 30-minute intervals up to four hours
 - ◆ 1-hour intervals up to nine hours (LP)**Result:** The length is displayed on the television displays. The selected programme is recorded for the length of time requested. At the end of that time, the VCR stops recording automatically.
- 8 If you wish to cancel the recording before the end, press VCR STANDBY/ON.

- ➡ If the end of the tape is reached while recording:
- ◆ The recording stops
 - ◆ The VCR automatically turns off

GB

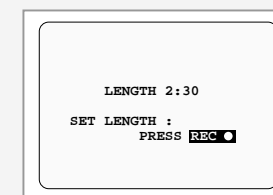
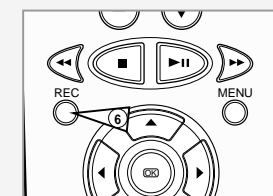
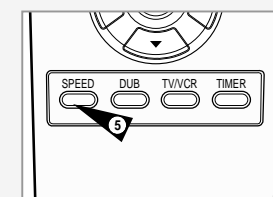
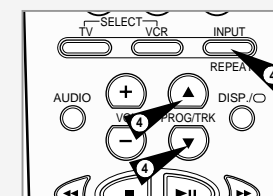
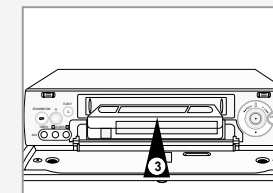

Using the VIDEOPLUS+ Feature

GB

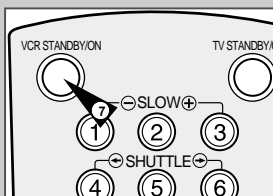
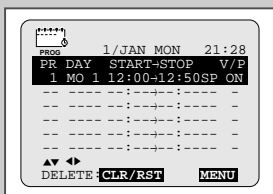
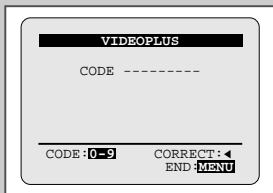
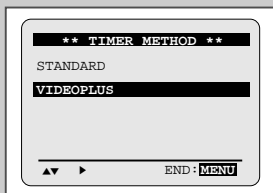
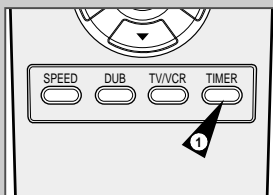

Before presetting your VCR:

- ◆ Switch on both the television and your VCR
- ◆ Check that the date and time are correct
- ◆ Insert the cassette on which the programme is to be recorded (safety tab intact)

Up to six programmes can be preset.

- 1 Press the TIMER button.
Result: The **TIMER METHOD** is displayed.
- 2 Press the corresponding ▲ or ▼ buttons, until the **VIDEOPLUS** option is selected.
- 3 Press the ► button to select **VIDEOPLUS**.
Result: A message is displayed to allow you to enter the VIDEOPLUS+ code.
 - ☞ If all six programmes have been set, the message **TIMER IS FULL** is displayed. Refer to page 27 if you wish to cancel a preset recording.
- 4 Press the numeric buttons to enter the code opposite the programme that you wish to record in your television magazine.
 - If you wish to correct the VIDEOPLUS+ code that you are entering:
 - ◆ Press the ◀ button until the digit to be corrected is cleared
 - ◆ Enter the correct digit
- 5 Press the MENU button.
Result: The information concerning the programme is displayed.
 - ☞ When using the VIDEOPLUS+ function for the first time with stored stations, the programme number flashes. This one time, you must enter the station number manually by pressing the ▲ or ▼ buttons. Refer to the following page if:
 - ◆ The programme number or times flash
 - ◆ You wish to modify the programme
- 6 If the programme and times are correct, press the MENU button.
- 7 Press the VCR STANDBY/ON button to activate the timer.
- 8 Refer to page 27 if you wish to:
 - ◆ Check that your VCR has been programmed correctly
 - ◆ Cancel a preset recording

☞ The numbers next to each TV programme listing are VIDEOPLUS+ code numbers, which allow you to programme your videorecorder instantly with the remote control. Tap in the VIDEOPLUS+ code for the programme you wish to record.

™ VIDEOPLUS+ is a trademark of Gemstar Development Corporation. The VIDEOPLUS+ system is manufactured under licence from Gemstar Development Corporation.

Modifying VIDEOPLUS+ Programming

GB

If you wish to correct the programme displayed or modify certain elements, such as the recording speed, you can do so before you press MENU a second time to confirm.

If you wish to...	Then...
Select an input source other than the tuner (AV1, AV2 or AUX)	<ul style="list-style-type: none"> ◆ Press the ◀ or ► buttons, until the PR selection flashes. ◆ Press the INPUT button one or more times to change the input source selection. Result: The programme number is replaced by: <ul style="list-style-type: none"> • The A1, A2 or AU source using the INPUT button for a satellite tuner or external video source ➤ The input source must be selected before changing any other value.
Record a programme every day (Monday to Sunday) at the same time	<ul style="list-style-type: none"> ◆ Press the ◀ or ► buttons, until the DAY selection flashes. ◆ Press the ▲ or ▼ buttons, until the DLY (Daily) value is displayed.
Record a programme every week on the same day and at the same time	<ul style="list-style-type: none"> ◆ Press the ◀ or ► buttons, until the DAY selection flashes. ◆ Press the ▲ or ▼ buttons, until the W- (Week) value is displayed, followed by the required day. Example: W-SA (Weekly Saturday)
Extend the recording time	<ul style="list-style-type: none"> ◆ Press the ◀ or ► buttons, until the STOP selection flashes. ◆ Press the ▲ or ▼ buttons to increase or decrease the stop time.
Select the recording speed	<ul style="list-style-type: none"> ◆ Press the ◀ or ► buttons, until the recording speed selection flashes. ◆ Press the ▲ or ▼ buttons until the correct indication is displayed: <ul style="list-style-type: none"> • AUTO (Auto Tape Speed Select) : see page 26 • SP (Standard Play) • LP (Long Play)
Select the PDC recording	<ul style="list-style-type: none"> ◆ Press the ◀ or ► buttons, until the V/P selection flashes. ◆ Press the ▲ or ▼ buttons until the "ON" indication is displayed. ☞ Do not select PDC unless you are sure the programme you wish to record is broadcast with PDC. If you do set PDC ON (by selecting "ON" in the right - hand column on the screen), then you must set up the start-time EXACTLY according to the published TV schedule. Otherwise the timer recording won't take place.
Preset a programme title	<ul style="list-style-type: none"> ◆ Press OK during the timer programming procedure or in the timer programming screen. ◆ Press the ▲ or ▼ buttons to select a character. To move to the next or previous character, press the ◀ or ► buttons respectively. ◆ If you wish to store the title, press OK.

Using the Timer Programming Feature

GB

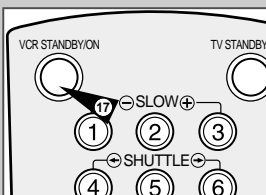
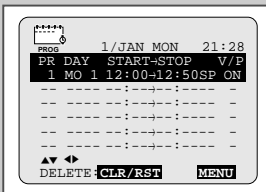
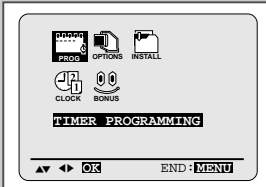
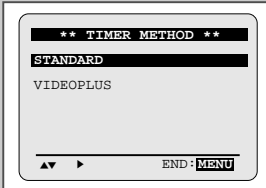

The **Timer Programming** feature allows you to preset the VCR to record a programme up to one month before that programme is to be broadcast. Up to six programmes can be preset.

Before presetting a recording, check that the date and time are correct.

- 1 - Insert the cassette. Press the **TIMER** button. Press the **▲** or **▼** buttons to select the **STANDARD** option and then press the **▶** button or,
 - ◆ Press **MENU** on the remote control.
 - Result:** The programming menu is displayed.
 - ◆ Press the **OK** button to select **TIMER PROGRAMMING** option.
 - Result:** The **TIMER PROGRAMMING** menu is displayed.
- 2 Press **▶** to select the input source.
- 3 Select the required station by pressing the **▲**, **▼** buttons or **INPUT** to select the **AV1**, **AV2** or **AUX** input sources.
- 4 Press **▶** to select the recording day.
- 5 Select the required day by pressing the **▲** or **▼** buttons.
- 6 Press **▶** to select the recording start time.
- 7 Select the required hour value by pressing the **▲** or **▼** buttons.
- 8 Press **▶** to select the minutes.
- 9 Select the required minute value by pressing the **▲** or **▼** buttons.
- 10 Press **▶** to select the recording end time.
- 11 Select the required recording end time by pressing the **▲** or **▼** buttons, following the same procedure as when selecting the recording start time.
- 12 Press **▶** to select the recording speed.
- 13 Press the **▲** or **▼** buttons to select the **SP** (Standard Play), **LP** (Long Play), **AUTO** (Auto Tape Speed Select) recording speeds.
- 14 Press **▶** to select the PDC recording mode.
- 15 Press the **▲** or **▼** buttons to toggle between the PDC mode (marked **ON**) and the non-PDC mode (marked **-**).
- 16 When you have finished, press the **MENU** button.
- 17 Press the **VCR STANDBY/ON** button to activate the timer.

- Preset a programme title
- ◆ Press **OK** during the timer programming procedure or in the timer programming screen.
 - ◆ Press the **▲** or **▼** buttons to select a character. To move to the next or previous character, press the **◀** or **▶** buttons respectively.
 - ◆ If you wish to store the title, press **OK**.

Checking a Preset Recording

You can check your preset recordings:

- ◆ When you have finished presetting the VCR
- ◆ If you have forgotten which programmes will be recorded

- 1 - Insert the cassette. Press the **TIMER** button. Press the **▲** or **▼** buttons to select the **STANDARD** option and then press the **▶** button or,
 - ◆ Press **MENU** on the remote control.
 - Result:** The programming menu is displayed.
 - ◆ Press the **OK** button to select **TIMER PROGRAMMING** option.
 - Result:** The **TIMER PROGRAMMING** menu is displayed.
- 2 Press the **▲** or **▼** buttons to select the required programme.
- 3 Press the **◀** or **▶** buttons to select and change any values as required. For more details, refer to the previous page.
- 4 On completion, press **MENU** twice.

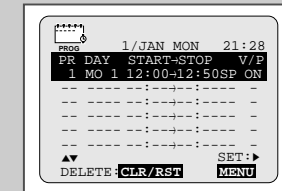

GB

Cancelling a Preset Recording

You can cancel any programmes that are:

- ◆ **Incorrect**
- ◆ **No longer required**

- 1 - Insert the cassette. Press the **TIMER** button. Press the **▲** or **▼** buttons to select the **STANDARD** option and then press the **▶** button or,
 - ◆ Press **MENU** on the remote control.
 - Result:** The programming menu is displayed.
 - ◆ Press the **OK** button to select **TIMER PROGRAMMING** option.
 - Result:** The **TIMER PROGRAMMING** menu is displayed.
- 2 Select the programme to be cancelled by pressing the **▲** or **▼** buttons.
- 3 Press the **CLR/RST** button to cancel the selected programme.
 Result: All the recording information is deleted and the broadcast will not be recorded.
- 4 On completion, press **MENU** twice.

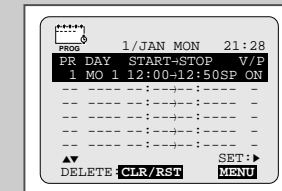

Before starting recording, the VCR compares the timer duration with the remaining time on the cassette.

- Auto Tape Speed Select. The VCR's "Auto Tape Speed Select" function compares the duration of the timer recording to the actual recording time remaining on the tape loaded. If there is insufficient tape to complete a timer recording in **AUTO** mode, the VCR automatically switches to **LP** mode to record the whole programme.

Playing a Cassette

GB

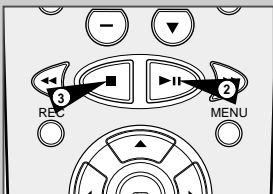

This function allows you to play back any pre-recorded cassette.

- 1 Switch on both the television and your VCR.
- 2 Insert the video cassette to be played. If the safety tab on the cassette is intact, press ►II.

Otherwise, the cassette is played automatically.

- When a cassette is loaded, the tape position is optimized automatically to reduce disturbance (Digital Auto Tracking). When playing a cassette, if the end of the tape is reached, the cassette is rewound automatically. NTSC tapes can be played back but cannot be recorded with this VCR.

3 To...	Then press...
Stop the playback	■ (STOP).
Eject the cassette	▲ (EJECT).

Adjusting Picture Alignment Manually



The Picture Adjustment feature allows you to adjust the alignment manually to obtain the best possible picture.

When noise bars or streaks appear during playback, adjust alignment manually by pressing the PROG/TRK (▲ or ▼) buttons until the picture is clear and stable.

- Result:**
- ◆ The tracking bar appears.
 - ◆ The image is adjusted.
 - ◆ The tracking bar disappears when you release the button.

Intelligent Picture Control

The Intelligent Picture Control Feature allows you to adjust the sharpness of the image automatically, according to your own preferences.

- 1 During playback, press the MENU button on the remote control.
Result: The programming menu is displayed.
- 2 Press the corresponding ▲, ▼ or ◀, ▶ buttons to select the **USER SET** option.
- 3 Press the OK button to select this option.
Result: The **USER SET** menu is displayed.
- 4 Press the corresponding ▲ or ▼ buttons, until the **IPC** option is selected.
- 5 Press the ▶ button to select the IPC (intelligent picture control) option.
 - When intelligent picture control mode is **ON**, the sharpness of the image is adjusted automatically.
- 6 To adjust the sharpness manually, press the ▼ button to turn the IPC mode **OFF**.
- 7 Press the ◀ or ▶ buttons until the picture is displayed according to your preferences.
 - If you do not press a button within ten seconds, the **PICTURE** menu disappears automatically.
- 8 On completion, press the MENU button again.

GB

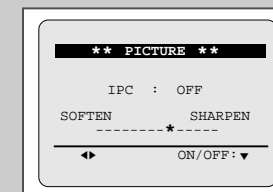
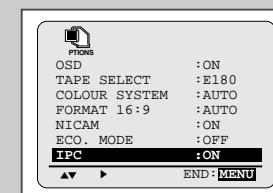
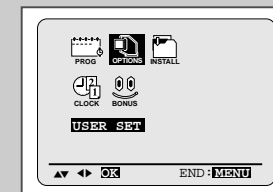

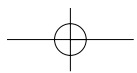

Format 16:9 (Wide Screen)

GB

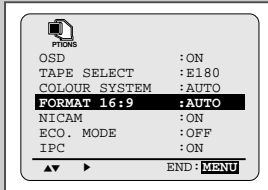
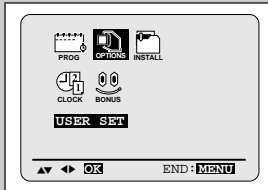

Your VCR can automatically play Wide Screen format prerecorded tapes. It can also record Wide Screen format programmes received from sources such as a satellite receiver.

➔ Connect equipment compatible with Wide Screen to the VCR using the 21 pin SCART cable.

- 1 Press MENU on the remote control.
Result: The programming menu is displayed.
- 2 Press the corresponding ▲, ▼ or ◀, ▶ buttons to select the **USER SET** option.
- 3 Press the OK button to select this option.
Result: The **USER SET** menu is displayed.
- 4 Press the corresponding ▲ or ▼ buttons, until the **FORMAT 16:9** option is selected.
- 5 Press the ▶ button to select **AUTO** → **ON** → **OFF**.

AUTO	Set when you use a wide TV. The VCR automatically detects if programmes being played back or recorded are in normal or Wide Screen format.
ON	The VCR always plays back and records in 16:9 Wide Screen format. Set if the VCR cannot detect Wide Screen TV programmes with "AUTO" set.
OFF	Set if you do not use a Wide Screen TV.

- 6 On completion, press MENU twice to exit the menu.

Selecting the Colour Mode

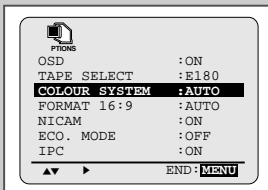

Before recording or playing back a cassette, you can select the required system standard.

Otherwise, the system automatically selects the reception standard when you select AUTO.

- ◆ When playing back a cassette, the standard is automatically selected by the VCR.
- ◆ When you playback an NTSC-recorded tape on this VCR make a setting on the colour system according to your TV. If your TV is a PAL system only TV, set NTPB. If your TV is Multi System TV (NTSC 4.43 compatible), set NT4.43 and you can record NT4.43.

- 1 Press MENU on the remote control.
Result: The programming menu is displayed.
- 2 Press the corresponding ▲, ▼ or ◀, ▶ buttons to select the **USER SET** option.
- 3 Press the OK button to select this option.
Result: The **USER SET** menu is displayed.
- 4 Press the corresponding ▲ or ▼ buttons, until the **COLOUR SYSTEM** option is selected.
- 5 Press the ▶ button to select **AUTO** → **PAL** → **B/W**.

AUTO	When playing back a cassette, the system standard is automatically selected by the VCR.
B/W	Black and White

- 6 On completion, press MENU twice to exit the menu.

Selecting the Audio Output Mode

GB

When monitoring a TV programme or playing back a Hi-Fi recorded video tape, press the **AUDIO** button to select a desired sound output. As the **AUDIO** button is pressed, the sound output and the indicator change as below:

Sound type	Stereo sound	Bilingual sound	Standard sound broadcast
OSD display	Heard in stereo. (left channel and right channel)	Channel I (MAIN) heard from the left speaker, channel II (SUB) heard from the right speaker.	Heard in monaural.
	Left channel heard from both the left and right speakers.	Channel I (MAIN) heard from both the left and the right speakers.	Heard in monaural.
	Right channel heard from both the left and right speakers.	Channel II-(SUB) heard from both the left and the right speakers.	Heard in monaural.
MIX	Sound mixed the left and right channels, and the normal audio track.		
MONO	Heard in monaural.	Channel I (MAIN) heard from both the left and the right speakers.	Heard in monaural.

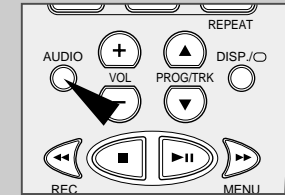

Playing a Cassette in Slow Motion

GB

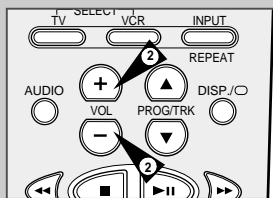

You can play a cassette in slow motion.

- No sound is heard when playing back a cassette in slow motion.

- 1 Press:
 - ◆ ►|| to start playing the cassette
 - ◆ SLOW (◀ or ▶) as many times as required to decrease or increase the speed respectively
 - ◆ To return to the normal speed, press the ►|| button twice.
- 2 When playing back in slow motion, picture interference may occur. Press the PROG/TRK (▲ or ▼) buttons to minimize this effect.

- When you have been using the Slow Motion function for more than about five minutes, the VCR will automatically play to protect the:
 - ◆ Cassette
 - ◆ Video heads

Playing a Sequence Frame by Frame

You can:

- ◆ Stop the cassette at a given frame (image)
- ◆ Advance one frame at a time

➤ No sound is heard when playing back frame by frame.

- 1 Press:
 - ◆ ► to start playing the cassette
 - ◆ ► to stop the tape at a given frame
 - ◆ F.ADV () to advance frame by frame

- 2 To return to normal playback, press ►.

☞ When you have been using the Frame-by-Frame function for more than about five minutes, the VCR will automatically play to protect the cassette and video heads.

➤ Vertical stability: When playing back frame by frame, interference may be seen on the screen. Press the V-LOCK () buttons to minimize this effect.

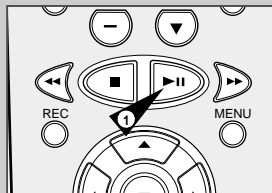

GB

Picture Search, Fast Forward/Rewind

Picture Search enables you to Fast Forward or Rewind and look for a particular part of a tape.

- 1 Press PLAY, the VCR will enter normal play mode. While in play, press and release the ► (or ◀) button. The VCR will search at 5 times the normal playback speed.
- 2 To return to normal playback mode, press the ► button.
- 3 If you press and HOLD down the ► (or ◀) button the VCR will search at 9 times the normal speed. Releasing the ► button will return the VCR to search at 5 times the normal speed. To return to normal playback mode, press the ► button.
- 4 Whilst in Picture Search mode, if you press the ► button again, the VCR will enter normal Fast Forward mode.
- 5 Likewise, whilst in Picture Search ◀ mode, if you press the ◀ button again, the VCR will enter normal Rewind mode.
- 6 If, when Redwing (◀) or Fast Forwarding (►), you press the ◀ (or ►) button, the VCR will enter the Picture Search mode.

Searching for a Specific Sequence

GB

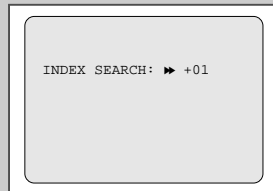
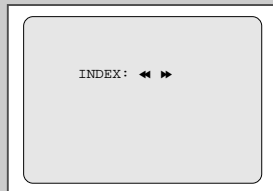

Each time you record a cassette on this VCR, an "index" is automatically marked on the tape when recording starts. The Search function allows you to fast-forward or rewind to a specific index and start playback from that point. Depending on the direction selected, the indexes are numbered as follows:

etc.	Prev Seq.	Seq. being played	Next Seq.	etc.
	2	1	1	2

➤ This VCR uses a standard indexing system (VISS). As a result, it will recognize any indexes marked by other VCRs using the same system and vice versa.

INTRO SCAN

- 1 To search for a specific index, press INDEX.
- 2 Press the ◀ or ▶ buttons depending on the direction where your desired programme is located.
- 3 When an Index mark is found the VCR will playback the tape for 5 seconds, after which it will continue searching for the next Index mark.
- 4 If you want to watch the tape from a particular Index, simply press ▶||.

Index Skip Search:

This feature will enable you to fast forward/rewind to a specific point on a tape: E.g. if you have recorded 3 different programmes on a tape and you have rewound the tape to the beginning, by using this feature you can go directly to the start of programme 2 simply by pressing the INDEX button.

- 1 Press the INDEX to start the Index search.
- 2 Press the ◀ or ▶ buttons twice more. This will take you directly to the start of the desired programme is located.
- 3 These Index searches can be made forwards: (press ▶) or backwards: (press ◀).
- 4 To cancel an Index search simply press the ▶|| or ■ button.

Auto Repeat Play

You can set repeat play to repeat the tape continuously from beginning to end.

- 1 Press MENU on the remote control.
Result: The programming menu is displayed.
- 2 Press the corresponding ▲, ▼ or ◀, ▶ buttons to select the **EASY OPERATION** option.
- 3 Press the OK button to select this option.
Result: The **EASY OPERATION** menu is displayed.
- 4 Press the corresponding ▲ or ▼ buttons, until the **REPEAT PLAY** option is selected.
- 5 To... **Press ◀ or ▶, until...**
Repeat play **ON** is displayed.
Do not wish to repeat play **OFF** is displayed.
- 6 On completion, press MENU twice to exit the menu.

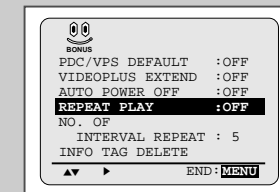

GB

Interval Repeat Play

You can set Interval Repeat Play so that the cassette is repeated a number of times according to a specified set interval.

- 1 Press MENU on the remote control.
Result: The programming menu is displayed.
- 2 Press the corresponding ▲, ▼ or ◀, ▶ buttons to select the **EASY OPERATION** option.
- 3 Press the OK button to select this option.
Result: The **EASY OPERATION** menu is displayed.
- 4 Press the corresponding ▲ or ▼ buttons, until the **NO. OF INTERVAL REPEAT** option is selected.
- 5 To... **Press ▶, until...**
Interval Repeat Play 5, 10, 15 is displayed.
(choose an interval repeat of 5, 10 or 15 times)
Cancel Interval Repeat Play **OFF** is displayed.
- 6 On completion, press MENU twice to exit the menu.
- 7 To select Interval Repeat Play during playback, press the INPUT/REPEAT button at the desired start point.
Result: "INTERVAL REPEAT SETTING" is displayed.
Press the INPUT/REPEAT button one more time at the desired end point.
Result: The tape is automatically rewound to the start point. "INTERVAL REPEAT" is displayed.

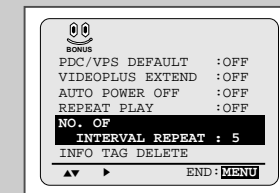

Info Tag (Information Tag) Function

GB

If you record multiple programmes on a tape, you can use the Info Tag function to see what has been recorded on your tape.

You can see programme list of programmes recorded on a tape.

You can also start playback directly from the selected programme using the INFO TAG LIST screen.

The data of the tape inserted into the VCR is automatically stored in memory.

If you want to recall the data of pre-recorded tape, press OK to select INFO TAG LIST screen.

Each time you timer record a cassette on this VCR, an "index of tape number" is automatically marked on the tape during the recording.

When a pre-recorded cassette is loaded, the VCR will search to find a tape number automatically for a few second.

Remarks : You can store information for up to 50 programmes on a tape.

Searching the Info Tag data.

- When a cassette have a safety tab is loaded, the VCR will search to find a INFO TAG automatically for a few second.
If the safety tab on the cassette is not intact, the cassette is played automatically.
- The process will finish after a few seconds. Then the VCR automatically display the results of searching data.
Screen "REMAIN INFO TAG DATA : --" will be displayed if INFO TAG DATA found.
- Screen "THERE IS NO INFO TAG DATA" will be displayed if no INFO TAG DATA found.

SEARCHING
INFO TAG DATA

REMAIN
INFO TAG DATA : --

THERE IS NO
INFO TAG DATA

Searching using the Info Tag (Information Tag) Function

You can store Info Tag, such as the recording date and programme position, for up to 50 programmes.

You can select a programme and start playback, by recalling the Info Tag directly from the Info Tag screen.

- If you want to recall the data of pre-recorded tape, press OK to select INFO TAG LIST screen. You can display the data of the programme list.
- Press the ▲ or ▼ buttons to select the required programme.
- Press ► to search required programme.
The VCR will starts searching, and playback starts automatically from the beginning of the selected programme.

```

** INFO TAG LIST **
YMMDD PR TITLE
010325 AV1 MBN NEWS
010415 12 GOLF2000
011225 AUX BATMAN
011218 16 BET TONI
011020 17 MONEYLIN
▲▼ SEARCH:► END:MENU
  
```

```

** INFO TAG LIST **
YMMDD PR TITLE
010415 12 GOLF2000
011225 AUX BATMAN
011218 16 BET TONI
011020 7 JAY LEON
010225 7 X-FILES
▲▼ SEARCH:► END:MENU
  
```

Presetting the title

- The title presetting feature allows you to store the title.
To preset the programme's name or theme, press OK during the timer programming procedure or in the timer programming screen.
The title inserting screen will be displayed.
- The first letter of the theme will be flashes.
To select a character, press the ▲ or ▼ buttons until the required character is displayed.
- To move to the next or previous character, press the ◀ or ▶ buttons respectively.
- If you wish to store the title, press OK.
If you do not wish to store the theme, press CLR/RST.

```

*****
PROG 12/JAN MON 14:00
PR DAY START-STOP V/P
1 MO 1 13:00 15:00SP
*A2 MO12 10:30 11:00SP
*12 MO13 10:40 11:00LP
▲▼◀▶ TITLE:OK
DELETE:CLR/RST MENU
  
```

```

** INPUT TITLE **

G O L F - - - -
◀▶▲▼ DELETE:CLR/RST MEMORY:OK
MENU
  
```

Deleting the Info Tag

GB

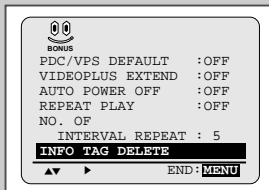

You can delete the programme information stored in VCR.

- 1 Press MENU press the corresponding ▲, ▼ or ◀, ▶ buttons to select the **EASY OPERATION** option.
- 2 Press the ▲ or ▼ buttons to select **INFO TAG DELETE** option and then press the ▶ button.
- 3 Select the tape number to be cancelled by pressing the ◀ or ▶ buttons.
- 4 Press the CLR/RST button to delete the **INFO TAG** data of selected cassette.

VPS/PDC Default

GB

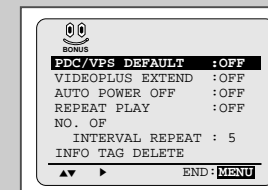
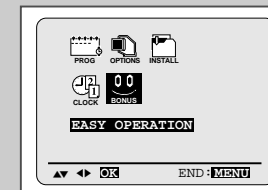

Programme VPS/PDC is a system of telling the VCR when a programme actually starts. Typically, when you want to record a programme you will tell the VCR to start recording, probably, five minutes before the advertised starting time of the programme and to finish ten minutes or so after the programme is due to finish. So even if the programme starts early or finishes late you will normally still get to see what you wanted to record. However when live programmes over-run or the day's television schedule is changed from that advertised, you may miss the desired programme which may have been delayed or even cancelled. With VPS/PDC the VCR will wait until the signal is sent to confirm the programme is starting and the VCR will record the programme even if it is two or more, hours late.

- 1 Press the MENU button on the remote control.
- 2 Press the corresponding ▲, ▼ or ◀, ▶ buttons to select the **EASY OPERATION** option.
- 3 Press the OK button to select this option.
Result: The **EASY OPERATION** menu is displayed.
- 4 Press the corresponding ▲ or ▼ buttons, until the **PDC/VPS DEFAULT** option is selected.
- 5 Press ▶ button to select ON in **PDC/VPS DEFAULT** option.
- 6 On completion, press MENU twice to exit the menu.

GB

VIDEOPLUS+ EXTEND

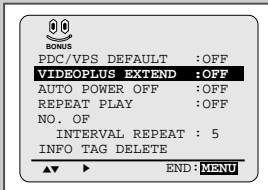

To prevent delays or over-runs the VCR has a function called Videoplus EXTEND allowing you to extend the recording time by up to 60 minutes.

➤ Only use if PDC is not available or set to OFF.

- 1 Press the MENU button on the remote control.
- 2 Press the corresponding ▲, ▼ or ◀, ▶ buttons to select the **EASY OPERATION** option.
- 3 Press the OK button to select this option.
Result: The **EASY OPERATION** menu is displayed.
- 4 Press the corresponding ▲ or ▼ buttons, until the **VIDEOPLUS EXTEND** option is selected.
- 5 Press ◀ or ▶ buttons to set the Videoplus EXTEND time by increments of 10 minutes.
- 6 To turn off, press ◀ or ▶ buttons repeatedly until **OFF** shows.

Using the Tape Counter

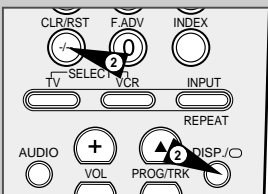
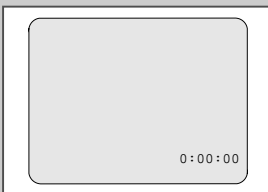

The tape counter:

- ◆ Indicates the elapsed time in the play and record modes (hours, minutes and seconds)
- ◆ Is reset when a cassette is inserted in the VCR
- ◆ Allows you to find the beginning of a sequence easily

➤ If the remaining time is to be calculated correctly, you must indicate the type of cassette being used.

- 1 Insert a cassette in your VCR.
- 2 To set the tape counter to zero at the beginning of a sequence:
 - ◆ Press DISP./O twice to display the counter
 - ◆ Press CLR/RST when you want to set the tape counter to zero
- 3 When you are ready,
 - ◆ Start playback or Recording.
 - ◆ Press the ■ button.
 - ◆ To fast-forward or rewind to the sequence at which the counter was set to zero, press ◀◀ or ▶▶.

➤ Some VCR information, such as the counter, can be displayed on the television screen (unless you have deactivated the OSD mode; refer to page 15).

Press DISP./O:

- ◆ Once to display the current function, programme number, recording speed, date, time and counter
- ◆ Twice to display the counter only
- ◆ Three times to display the time remaining on the cassette
- ◆ Four times to clear the display

AV-Link Function of this VCR

If your TV has "Easy Link / nexTVViewLink / AV-Link" function, the VCR can automatically store stations memorized in the TV in the same channel position as those of the TV.

Using a SCART cable (21 pins), a mutual control is available with the TV, VCR, SAT receiver, etc.

- The VCR automatically stores all your current TV stations in the VCR in the same position order as the TV channels. ("TV CH DOWNLOAD")
- Even if the TV is in standby mode, the TV automatically turns on and displays the video picture when you start playback on the VCR.
- The VCR automatically selects the same picture as you are watching on the TV, and record it. ("TV PICTURE")
- The VCR takes in the data and turns to timer standby mode, after a program data reserved is transferred to the VCR by a TV using such as an EPG (Electronic Program Guide). In this case, the TV's and the VCR's channel position must be set to the same TV station. The position could be stored from 1 to 80. Also the VCR's clock must be set.

Connection

Connect your EasyLink / nexTVViewLink / AV-Link TV to the AV1 (EURO AV) socket on the rear of the VCR using the SCART cable. Refer to your TV's manual additionally.

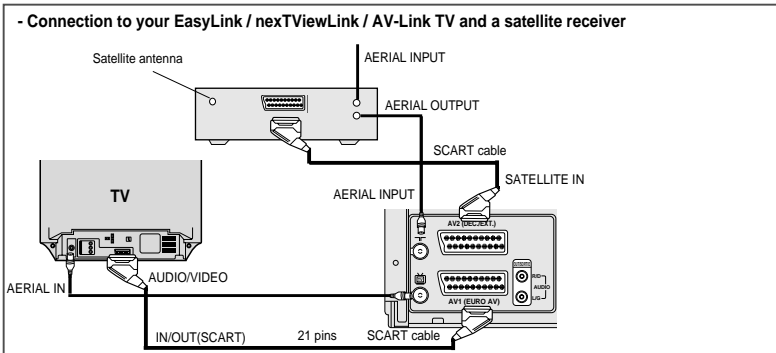
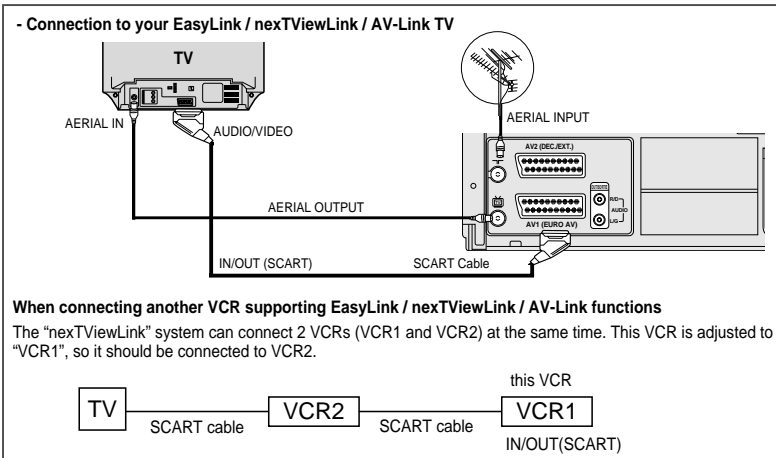

TV programme Download

GB

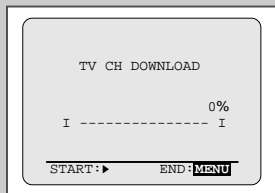
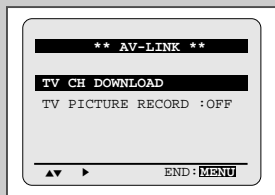
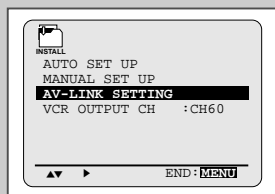
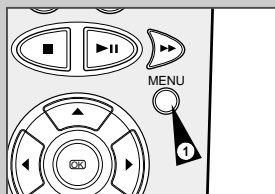
**Preparation:**

- ◆ Turn on the TV.
- ◆ Select the video channel or the video input mode on the TV.

- 1 Press the MENU on the remote control.
Result: The programming menu is displayed.
- 2 Press the corresponding ▲, ▼ or ◀, ▶ buttons to select the **INSTALLATION** option.
And then press the OK button to select this option.
Result: The **INSTALLATION** menu is displayed.
- 3 Press the ▲ or ▼ buttons to select **AV-LINK SETTING** option.
And then press the ▶ button to select this option.
Result: The **AV-LINK SETTING** menu is displayed.
- 4 Press the ▲ or ▼ buttons, until the **TV CH DOWNLOAD** option is selected.
And then press the ▶ button to select this option.
- 5 Press the ▶ button to start **TV CH DOWNLOAD** function.
- 6 When the downloading finished, then "TV CH DOWNLOAD **FINISHED**" is displayed.
- 7 Press the MENU button to exit.

- ◆ The available position numbers on the VCR are 1 to 80.
- ◆ When the TV's channel position is readjusted, the VCR automatically makes "TV CH DOWNLOAD".

TV Picture Record Setting

GB

Preparation : turn on the TV.

- 1 Press the MENU on the remote control.
Result: The programming menu is displayed.
- 2 Press the corresponding ▲, ▼ or ◀, ▶ buttons to select the **INSTALLATION** option.
And then press the OK button to select this option.
Result: The **INSTALLATION** menu is displayed.
- 3 Press the ▲ or ▼ buttons to select **AV-LINK SETTING** option.
And then press the ▶ button to select this option.
Result: The **AV-LINK SETTING** menu is displayed.
- 4 Press the ▲ or ▼ buttons, until the **TV PICTURE RECORD** option is selected.
- 5 To... Press ◀ or ▶ until...
Record the same picture as you are watching on the TV when you press REC button (●) on the your VCR remote control. ON is displayed.
Record the selected picture on your VCR when you press REC button (●) on your VCR remote control. OFF is displayed.
- 6 Press the MENU button twice to exit.

- If this option is in ON mode, you press the REC button (●) on the your TV remote control, your VCR records the same picture as you are watching on the TV.

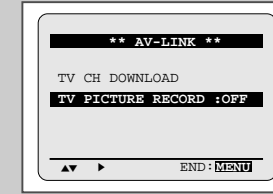
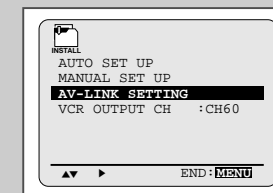
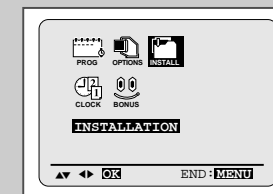

Direct Record Procedure

- 1 Load a cassette with the safety tab attached.
- 2 Press the SPEED button to select the recording tape speed.
- 3 Press two REC buttons to start recording.
Result: The VCR automatically selects the same picture as you are watching on the TV and starts recording. Depending on the picture sources, the recording switches the method. See next page.
- 4 To stop a recording, press STOP (■) once.

- ◆ This recording is not available on the timer programme recordings.

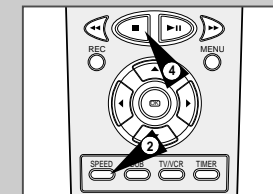

Pictures and TV Picture Recording

GB

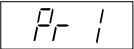
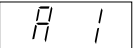
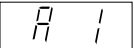
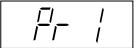
Picture	The VCR records:	During recording, if you change the channel or the input mode on the TV, the recording will be:
Channel selected on the TV If you performed "TV CH DOWNLOAD" (TV stations stored on the VCR and the TV in the same position order).	VCR channel of the same number as the TV channel	Ex. TV channel 1  Continued.
If you did not perform "TV CH DOWNLOAD" (TV stations not stored on the VCR and the TV in the same position order).	AV1 (output of the TV)	 Stopped.
Pictures of external equipment connected to the TV	AV1 (output of the TV)	 Stopped.
Channel selected on the VCR	VCR channel	Ex. VCR channel 1  Continued.

Connecting an RCA Audio/Video Input Cable

GB

You can connect other audio/video equipment to your VCR using audio/video cables if the appropriate outputs are available on the equipment chosen.

Examples: ♦ You wish to copy a video cassette with the help of a second VCR (see page 46).

♦ You wish to play back and/or copy pictures taken with a camcorder (see page 46).



♦ Make sure that both the television and the VCR are switched off before connecting the cables.

- 1 Connect one end of the RCA audio/video cable into the VIDEO socket on the front of the VCR.
- 2 Plug the other end of the audio/video cable into the appropriate output connector on the other system (VCR or camcorder).
- 3 Connect one end of the RCA audio cable into the AUDIO sockets on the front of the VCR.
➤ Take care to respect the colour coding of the left and right channels.
- 4 Plug the other end of the audio cable into the appropriate output connectors on the other system (VCR, camcorder or Hi-Fi sound system).

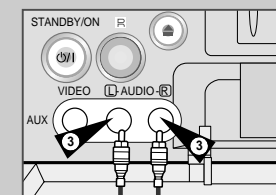
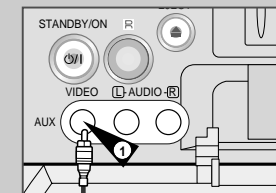

GB

Using the Assemble Edit Function

This function allows you to start a new recording at a specific position on the cassette while maintaining a very smooth scene change.

- 1 Insert the cassette to be edited in your VCR.
- 2 Press the ►|| button to start playback.
- 3 When you reach the position from which you wish to start the new recording, press the ►|| button.
- 4 Press the F.ADV () button again as often as necessary to advance frame by frame, until the exact recording position is located.
- 5 While the VCR is in still mode, hold the REC button down for a while to activate the Assemble Edit function.
Result: Record symbol flashes in the display.
- 6 Select the source from which you wish to record by pressing:
 - ◆ The PROG/TRK (▲ or ▼) buttons for television channels
 - ◆ The INPUT button for the AV1, AV2 or AUX input sources
- 7 Press the ►|| button to start recording.
- 8 When you have finished recording, press ■.

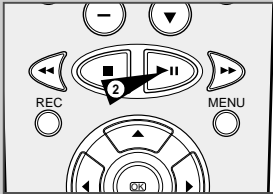

Recording from Another VCR or Camcorder

You can copy a cassette to your VCR from another video source, such as another VCR or a camcorder.



It is an infringement of copyright laws to copy prerecorded cassettes or to re-record them in any form without the permission of the owners of the corresponding copyright.

- 1 Connect the VCR, from which the cassette is to be copied, to the appropriate SCART audio and video input connectors on the rear of your VCR.
You can also use a RCA audio and video cable to connect the AUX input on the front of your VCR.
- 2 Insert a blank cassette in your VCR.
- 3 Insert the pre-recorded cassette in the other video source (VCR or camcorder).
- 4 Press the INPUT button to select the appropriate input on your VCR:
 - ◆ AV1 or AV2 for the SCART input
 - ◆ AUX for the RCA input
- 5 Start playing back the cassette to be copied.
- 6 Hold REC down for a while to start recording on your VCR.
- 7 When you have finished recording, press ■ on both VCRs.



If you wish to view the cassette being copied:

- ◆ Your VCR must be connected as usual to the television (see page 10 for further details)

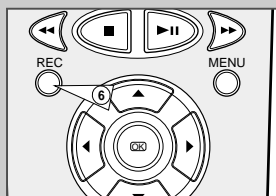
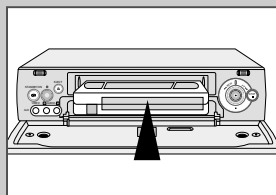

Audio Dubbing a Pre-recorded Cassette

With the Audio Dubbing function, you erase the previously recorded sound and replace it with a new soundtrack from:

- ◆ A CD player
- ◆ A microphone connected to a sound system
- ◆ A cassette player

Restriction:

Audio dubbing is applicable only to the longitudinal audio track (normal audio).

- 1 Connect an RCA audio cable to the appropriate output on your sound system (CD/cassette player for example).
- 2 Connect the other end of the RCA audio cable to the audio input connectors (L, R) on the front of your VCR.
- 3 Insert the pre-recorded cassette on which the audio track is to be replaced, and press the ►|| to start playback.
- 4 Find the scene that you want to over-dub and press ►|| on the remote control.
- 5 Press DUB.
Result: Your VCR is now in the Audio dubbing Pause mode.
- 6 On the sound system, locate the point on the CD or cassette at which you wish to start playback.
Example: The track that you wish to record on the cassette.
- 7 When you are ready:
 - ◆ Start playback on the sound system
 - ◆ Press REC on the remote control.**Result:** The soundtrack is replaced on the pre-recorded cassette.



The new sound will be recorded on the normal sound track of the tape, and the original sound will remain on the Hi-Fi sound track.
To hear the new sound and original sound mixed together, press the Audio button on the remote control until the MIX option is displayed (see page 34).

GB

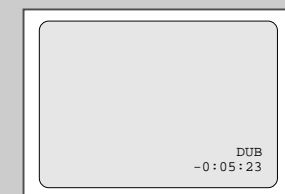
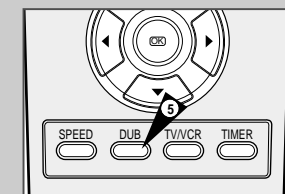
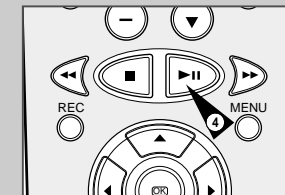
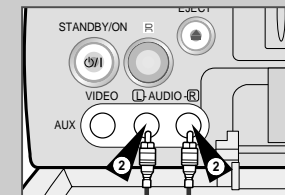
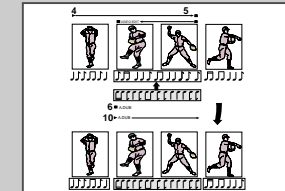

Using the TV Buttons on the Remote Control

GB

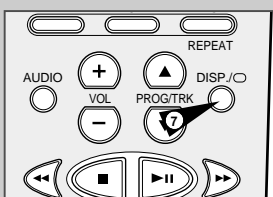
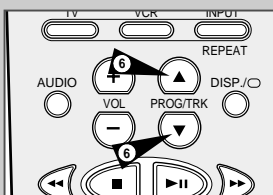
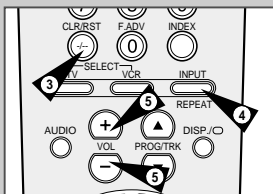
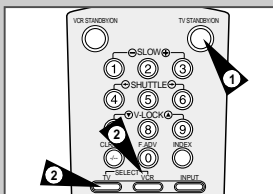

Your VCR remote control will work with Samsung televisions and compatible brands.

To determine whether your television is compatible, follow the instructions below.

- 1 Switch your television on.
- 2 Point the remote control towards the television.
- 3 Hold down the TV button and enter the two-figure code corresponding to the brand of your television, by pressing the appropriate numeric buttons.

Brand	Codes	Brand	Codes
SAMSUNG	01 to 06	PHILIPS	02, 20, 22
AKAI	09, 23	SABA	13, 14, 22 to 24
GRUNDIG	09, 17, 21	SONY	15, 16
LOEWE	02	THOMSON	13, 14, 24
PANASONIC	08, 23 to 27	TOSHIBA	07, 16 to 19, 21

Result: If your television is compatible with the remote control, it is switched off. It is now programmed to operate with the remote control.

➤ If several codes are indicated for your television brand, try each one in turn until you find one that works.

✎ When you change the batteries in the remote control, you must reprogramme the code, following the same procedure.

You can then control the television using the following buttons.

Button	Function
TV STANDBY/ON ①	Used to switch the television on and off.
TV or VCR ②	Used to switch between the TV and VCR modes. Only the VOL (+ or -) and TV STANDBY/ON buttons are operational in VCR mode.
-/- ③	Used to enter a two-figure programme number. Example: For programme 12, press -/- followed by numeric buttons 1 and 2.
INPUT ④	Used to select an external source.
VOL + or - ⑤	Used to adjust the volume of the television.
PROG/TRK ⑥ (▲ or ▼)	Used to select the required programme.
DISP/○ ⑦	Used to switch between an external source and the television tuner.

➤ The various functions will not necessarily work on all televisions. If you encounter problems, operate the television directly.

Auto Power Off

The Auto Power Off feature automatically turns off your VCR if no signal is received and you do not press any button for the selected time.

- 1 Press MENU on the remote control.
Result: The programming menu is displayed.
- 2 Press the corresponding ▲, ▼ or ◀, ▶ buttons to select the **EASY OPERATION** option.
- 3 Press the OK button to select this option.
Result: The **EASY OPERATION** menu is displayed.
- 4 Press the corresponding ▲ or ▼ buttons, until the **AUTO POWER OFF** option is selected.
- 5 Press the ▶ button, until you select the time of Auto Power off interval.
OFF → 2HOUR → 3HOUR
- 6 On completion, press MENU twice to exit the menu.

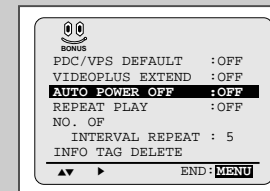

ECO Mode-Reducing Standby power consumption

Low Power Mode reduces the Standby power consumption of the VCR when in Standby mode. Useful, for example, when you are away from the house on holiday. It saves actually turning the VCR off.

- 1 Press MENU on the remote control.
Result: The programming menu is displayed.
- 2 Press the corresponding ▲, ▼ or ◀, ▶ buttons to select the **USER SET** option.
- 3 Press the OK button to select this option.
Result: The **USER SET** menu is displayed.
- 4 Press the corresponding ▲ or ▼ buttons, until the **ECO. MODE** is selected.
- 5 Press the ▶ button to turn LOW(3Watts) mode on. Now, when the VCR is standby mode the front display panel will shut off. Even the clock disappears. By pressing the STANDBY/ON button again the display panel will reappear.
- 6 On completion, press MENU twice to exit the menu.

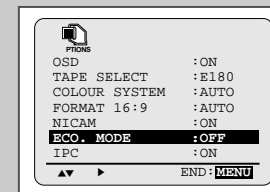

GB

Technical Specifications

Design and specifications are subject to change without notice.

Format	VHS PAL standard
Heads	Video: 4 rotary heads Hi-Fi audio: 2 rotary heads Audio/Control: 1 stationary head Erase: 1 full track erase head STANDARD I-NICAM STEREO
Television system	FM azimuth recording
Luminance	PAL: Down converted subcarrier phase shifted direct recording
Colour system	NTSC PB on PAL TV
Tape speed	SP 23.39 mm/sec LP 11.69 mm/sec
Recording/playback time	SP 3 hours (E-180 Tape) LP 6 hours (E-180 Tape)
REW time	About 60 sec in REW with E-180
VIDEO	
Input	0.5 to 2.0 Vp-p; 75 ohm unbalanced
Output	1.0 ± 0.2 Vp-p; 75 ohm unbalanced
Signal-to-noise ratio	Better than 43 dB (SP)
Horizontal resolution	More than 240 lines
AUDIO	
Input	-8 dBm, 47 Kohm unbalanced
Output	-8 ± 3 dBm, 1 Kohm unbalanced
Wow and flutter (WTD)	0.4% max (SP)
Signal-to-noise ratio	68 dB min (IHF A filter)
Frequency response	20Hz - 20kHz
Power requirement	230V (AC 50-60 Hz)
Power consumption	Approx. 17 watts
Operation temperature	41°F-104°F (5°C-40°C)
Operation humidity	10%-75%
Weight	2.8 Kg (net)
Dimensions (WxHxD)	360 x 94 x 240 mm

Problems and Solutions

Before contacting the Samsung after-sales service, perform the following simple checks.

Problem	Explanation/Solution
No power	<ul style="list-style-type: none"> ◆ Check that the power plug is connected to a wall outlet. ◆ Have you pressed the VCR STANDBY/ON button?
You cannot insert a video cassette	<ul style="list-style-type: none"> ◆ A video cassette can only be inserted with the window side up and the safety tab facing you.
The television programme was not recorded	<ul style="list-style-type: none"> ◆ Check the VCR aerial connections. ◆ Is the VCR tuner properly set? ◆ Check if the safety tab is intact on the cassette.
Timer recording was unsuccessful	<ul style="list-style-type: none"> ◆ Was the VCR STANDBY/ON button pressed to activate the timer? ◆ Re-check the recording start/stop time settings. ◆ If there was a power failure or interruption during timer recording, the recording will have been cancelled.
No playback picture or the picture is distorted	<ul style="list-style-type: none"> ◆ Check to see if you are using a prerecorded tape.
You cannot see normal broadcasts	<ul style="list-style-type: none"> ◆ Check the TUNER/EXTERNAL setting. It should be on TUNER. ◆ Check the TV/VCR aerial connections.
Noise bars or streaks on playback	<ul style="list-style-type: none"> ◆ Press the PROG/TRK (▲ or ▼) buttons to minimize this effect.
When the ► button is pressed during playback, the still picture has severe "noise bars" streaks	<ul style="list-style-type: none"> ◆ A still picture may have "noise bars", depending on the condition of the tape. Press the PROG/TRK (▲ or ▼) buttons during SLOW motion to minimize this effect.
Video Head Cleaning	<ul style="list-style-type: none"> ◆ If poor pictures appear on a variety of cassettes, the video heads may need cleaning. This is not a common problem and unless it appears, the heads should not be cleaned. When cleaning the video heads, read all instructions provided with the head cleaning cassette. Incorrect head cleaning can permanently damage the video heads.
If when tuning in your TV to the VCR test pattern your TV does not find the test pattern or the pattern when found suffers from interference, it may be due to the VCR output channel clashing with the normal TV transmissions in your area. To prevent this you will need to change the VCR output channel in the following way	<ol style="list-style-type: none"> 1. Remove the aerial input plug from the socket marked (aerial symbol) on the rear of the VCR. 2. Carry out the instructions "Tuning Your Television for the VCR" (see page 13). 3. Carry out the instructions "Setting the VCR output Channel" (see page 15), move the channel number several channels down from the original setting. (example: from 60 to 57). 4. Replace the aerial plug into the socket marked (aerial symbol) on the rear of the VCR. 5. Re-tune your TV to the VCR again by following instructions "Tuning Your Television for the VCR" (page 13). 6. If the problem still exists repeat steps 1 to 5 moving several more channels away from the original setting.

If you are unable to solve the problem after reading the above instructions, note:

- ◆ *The model and serial number on the rear of your VCR*
- ◆ *The warranty information*
- ◆ *A clear description of the problem*

Then contact your nearest SAMSUNG after-sales service.

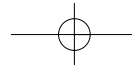

SAMSUNG ELECTRONICS (UK) LTD
AUTHORISED SERVICE CENTERS

In the event of warranty service being required, please contact your retailer first. If they cannot provide service, please contact your nearest service centre listed below. Service facilities are return to base, however some agents may provide an in-home service (there may be a cost for call out). Please refer to your warranty card or retailer for terms and conditions of the warranty.

<p>AVON BRISTOL GOOGLEBOX TV TEL: 01275 838083</p> <p>BERKSHIRE READING A & W SOUND & VISION TEL: 01734 872000 MAIDENHEAD J F ASSOCIATES TEL: 01628 25709 WARGRAVE J F ASSOCIATES TEL: 01734 401525</p> <p>CAMBRIDGESHIRE DRY DRAYTON DRAYTON ELECTRONICS TEL: 01954 211330 PETERBOROUGH DEEPIING TV SVCS TEL: 01778 343831</p> <p>CHESHIRE CHESTER H & H VIDEO & TV TEL: 01244 379579 WARRINGTON W L ELECTRONICS TEL: 01925 764387</p> <p>CORNWALL BIDE H B H WOOLACOTTS TEL: 01288 352269 LAUNCESTON H B H WOOLACOTTS TEL: 01568 772096 NEWQUAY GREENBANK ELECTRONICS TEL: 01637 880576 WADEBRIDGE H B H WOOLACOTTS TEL: 01208 816155</p> <p>CUMBRIA BARRROW IN FURNESS KENNETH GARDNER TEL: 01229 821202 SEARLE AUDIO TEL: 01229 839692 PENRITH CANNAN & BROWN TEL: 01768 864829</p> <p>DEVON HOLSWORTHY H B H WOOLACOTTS TEL: 01409 253280 NEWTON ABBOT TELLI-SCOPE ELECTRONICS TEL: 01626 63907 PLYMOUTH ARVYLE TV & VIDEO TEL: 01752 779833 CTV ELECTRONICS TEL: 01752 350950</p> <p>DORSET BOURNEMOUTH M & G ELECTRONICS TEL: 01202 523771</p> <p>DURHAM DURHAM LEE TECH SVCS TEL: 0181 371 1300 DARLINGTON GAZE ELECTRONICS TEL: 01325 482344</p> <p>DYFED CARMARTHEN ADVANCE CONSUMER TEL: 01267 236143 ST CLAIRS BEN EVANS & SON TEL: 01994 231015</p> <p>ESSEX BRAINTREE GWYNNE TV & ELECTRICAL TEL: 01376 322567</p>	<p>ESSEX WICKFORD CENTRAL SERVICE TEL: 01288 766333</p> <p>MID GLAMORGAN BRIDGEND BRIDGEND SERVICE TEL: 01656 663463</p> <p>GLOUCESTERSHIRE TREWESBURY SWITCH ELECTRONICS TEL: 01684 850063 WESTON-SUB-EDGE PROFESSIONAL ELECTRONIC TEL: 01386 841773</p> <p>HAMPSHIRE FAREHAM SOUND & VISION TEL: 01329 286851 FARNBOROUGH ICTV TEL: 01252 510118 PORTSMOUTH ICTV TEL: 01705 653654 SOUTHAMPTON OLYMPIC TV & AUDIO TEL: 01703 703401</p> <p>HEREFORD HEREFORD J P MICRO SVCS TEL: 01432 356353</p> <p>HERTFORDSHIRE BALDOCK TECHNICAL REPAIR SVCS TEL: 01462 491144 MARKYATE TELETECH SVCS TEL: 01582 841862</p> <p>NORTH HUMBERSIDE GOOLE HEADLAND ELECTRICS TEL: 01977 661223</p> <p>SOUTH HUMBERSIDE GRIMSBY RAYNERS SUPERSTORE TEL: 01472 358766</p> <p>KENT CANTERBURY BARRETT'S OF CANTERBURY TEL: 01227 766582 DARTFORD BUDGET REPAIR CENTRE TEL: 01322 227668 MAIDSTONE AVERY ELECTRONICS TEL: 01622 682138</p> <p>LANCASHIRE BLACKPOOL KENNETH GARDNER TEL: 01253 824047 LANCASTER KENNETH GARDNER TEL: 01524 64468 ROCHDALE CTV SERVICES TEL: 01706 654983</p> <p>LEICESTERSHIRE LEICESTER SOUND & VISION CENTRE TEL: 01162 730444</p> <p>LINCOLNSHIRE BRANSTON STUART WALLACE TEL: 01522 791496</p> <p>LONDON HIGH HOLBORN BERRYS OF HOLBORN TEL: 0171 405 1157</p> <p>LONDON ARMSTRONG SERVICES TEL: 0181 523 0023/0051 WEST EALING BABBET ELECTRONICS TEL: 0181 579 6315</p>	<p>LONDON WILLESDEN ATLANTIC ELECTRIC TEL: 0181 451 6155</p> <p>MANCHESTER ASHTON UNDER LYNE VIDEOTECH UK TEL: 0161 308 4092 NORTHENDEN G H SUMNER LTD TEL: 0161 988 2705</p> <p>MERSEYSIDE ELLESMEY PORT H & H VIDEO & TV TEL: 0151 357 1011 LIVERPOOL P & A AUDIO VIDEO LTD TEL: 0151 924 7287</p> <p>MIDDLESEX HAYES A & A REPAIRS TEL: 0181 561 2900/4104</p> <p>NORFOLK AYLESHAM CORTONS ELECTRICAL TEL: 01263 733391</p> <p>WATTON JULIAN HORN TEL: 01953 881440</p> <p>NORTHAMPTONSHIRE KETTERING INTEGRATED SVCS TEL: 01536 516475</p> <p>OXFORDSHIRE BANBURY HITECH TEL: 01295 267415 BOTLEY SPECTRUM ELECTRON TEL: 01865 250199</p> <p>SHROPSHIRE TELFORD W OWEN TEL: 01952 613818</p> <p>SOMERSET TAUNTON ARMTTECH ELECTRONICS TEL: 01823 279401 YEovil M J THOMAS TEL: 01935 477255</p> <p>STAFFORDSHIRE STOKE ON TRENT TELEFAULTS (S.O.T.) LTD TEL: 01782 813757</p> <p>SUFFOLK IPSWICH GSN LTD TEL: 01473 744300</p> <p>SURREY WALLINGTON SERVICECARE TEL: 0181 669 1145 HORLEY D K AUDIO VISUAL SVCS TEL: 01293 786459</p> <p>EAST SUSSEX SEAFOED CLEARVIEW RENTAL & RELAY TEL: 01323 898989 EASTBOURNE STARTEC SVCS TEL: 01323 412012</p> <p>TYNE & WEAR NEWCASTLE UPON TYNE M SINGH RADIO & TV TEL: 0191 226 0446</p> <p>WEST MIDLANDS COVENTRY D & J HENRY TEL: 01203 431393</p>	<p>WEST MIDLANDS DUDLEY J S STOREY ELECTRICAL TEL: 01384 456608 WALSALL BEAVER ELECTRONICS TEL: 01922 725554 WARLEY MERRIVALE TV SVCS TEL: 0121 544 6273/6350</p> <p>WILTSHIRE SWINDON COLORITE TV LTD TEL: 01793 641038</p> <p>WORCESTERSHIRE WORCESTER THE HI FI CAR RADIO REPAIR TEL: 01905 26623</p> <p>SOUTH YORKSHIRE SHEFFIELD GRAPHIC ELECTRONIC SVCS TEL: 0114 256 2791 BARNSLY ALTRA TEL: 01226 207434</p> <p>NORTH YORKSHIRE YORK DBS SERVICE CENTRE TEL: 01904 789789</p> <p>WEST YORKSHIRE BRADFORD GRAPHICK ELECTRON TEL: 01274 862267 HUDDERSFIELD GRAPHIC ELECTRONICS TEL: 01484 451045 ILKLEY R BEAUMONT TEL: 01943 607021</p> <p>CHANNEL ISLANDS GUERNSEY TELESKILL LTD TEL: 01481 56808 JERSEY ALTERNATIVE ELECT TEL: 01534 68277 ISLE OF WIGHT AUDIO VISION SVCS TEL: 01983 752023</p> <p>NORTHERN IRELAND CO ARMAGH CRAIGAVON TV SVCS TEL: 0762 326119/322505</p> <p>EIRE CO CORK TVAE REPAIRS TEL: 00353 21 273457</p> <p>GRAMPPIANS FRASERBURGH RODGERS ELECTRICAL TEL: 01346 518540</p> <p>HIGHLANDS ULLAPOOL R & R ELECTRONICS TEL: 01854 612608</p> <p>LOTHIAN EDINBURGH RETEC AUDIO & VISUAL TEL: 0131 478 7779</p> <p>STRATHCLYDE GLASGOW DSC ELECTRONICS TEL: 0141 941 3711</p> <p>TAYSIDE DUNDEE ANCRUM ELECTRONICS TEL: 01382 454511</p>
---	--	--	---

SAMSUNG EUROPEAN BLOC WARRANTY

WARRANTY

MODEL NAME
Modèlnavn, Nombre de modèle, Nome de modelo, Modelbezeichnung, Modelnaam, Nom du modèle, Il nome di modello, Modelo protector, Asakkaan puh.nro, Modelnaven, Model

SERIAL NO.
Seriennummer, No. de serie, Número serial, Seriennummer, Serie nummer, Numéro de série, Il numero di matricola, Arifnivo kataskainv, Mail, Seriennummer, Serienr

DATE OF PURCHASE
Kobletti, Kobletsdato, Fecha de compra, Data de compra, Kaufdatum, Datum van aankoop, Date d'achat, Un tæra d'ærgjæft, Dato for anskaffelse, Dato for anskaffelse, Datum der Anschaffung, Dato for kjøp

CUSTOMER'S NAME
Kundens navn, Nominne de cliente, Nombre du client, Nome de cliente, Nome des Kunden, Naam van klant, Nom du client, Il nome del cliente, Onomatopæwano tou agapasthy Sarjanto, Kunderens navn, Kunderens namn

CUSTOMERS TEL. NO.
Kundeadress, Kundetelefonnummer, No. de Tel. de client, No. de Tel. del cliente, Número de teléfono de cliente, Telefonnummer des Kunden, Telefon nummer van klant, Numéro de téléphone du client, Il numero de telefono del client, Arifnivo thle foneu tou agapasthy Myijän puh.nro, Kunderens telefonnr, Kunderens telefonnr.

CUSTOMER'S ADDRESS
Kundeadress, Kundeaddress, Dirección de cliente, Endereço de cliente, Adresse des Kunden, Adres van klant, adresse du client, L'indirizzo del cliente, Dirección de cliente, Adresse de marchand, D'ægjæush thle kataskainv, Asakkaan nimi, Forhandlens adresse, Handlens adress

DEALER'S NAME
Handlensnavn, Forhandler, Nombre de negociante, Nombre del vendedor, Nome de vendedor, Name des Händlers, Naam van handelaar, Nom du marchand, Il nome del commerciante, Onoma tou kataskainv, Jälleenmyyjän, Forhandler, Ateroforsælger

DEALER'S TEL. NO.
Handlensnummer, Forhandlertelefonnummer, No. de Tel. de negociante, No. de Tel. del vendedor, Número de teléfono de vendedor, Telefonnummer des Händlers, Telefon nummer van handelaar, Número del phone du marchand, Il numero di telefono del commerciante, Arifnivo thle foneu tou kataskainv, Myijän osasto, Forhandlens tel.nr., Handlens telefonnr.

DEALER'S ADDRESS
Handlensadress, Forhandleradresse, Dirección de negociante, Dirección del vendedor, Endereço de vendedor, Adresse des Händlers, Adres van handelaar, Adresse de marchand, D'ægjæush thle kataskainv, Asakkaan nimi, Forhandlens adresse, Handlens adress

CUSTOMER'S SIGNATURE

DEALER'S STAMP & SIGNATURE

CAUTION

Please ensure the form above is completed at the time of purchase and present it to the dealer to quality for guarantee service, otherwise your guarantee may be affected.

GUARANTEE

GARANZIA

GARANTI

GARANTÍA

GARANTIE

GARANTIA

ΕΠΙΥΨΗ

TAKUU

SAMSUNG

ELECTRONICS

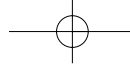

UNITED KINGDOM

This Samsung product is warranted for the period of twelve (12) months from the original date of purchase, against defective materials and workmanship. In the event that warranty service is required, you should return the product to the retailer from whom it was purchased.

However, Samsung Authorised Dealers and Authorised Service Centres in other EC Countries will comply with the warranty on the terms issued to purchasers in the country concerned. In case of difficulty, details of our Authorised Service Centres are available from:

**Samsung Electronics (U.K.) Ltd.,
Euro Service Centre, Stafford Park 12,
TELFORD, Shropshire TF3 3BJ,
Tel: 01952) 292262, Fax: 01952) 292033**

■ WARRANTY CONDITIONS

1. The warranty is only valid if, when warranty service is required, the warranty card is fully and properly completed and is presented with the original invoice or sales slip or confirmation, and the serial number on the product has not been defaced.
2. Samsung's obligations are limited to the repair or, at its discretion, replacement of the product or the defective part.
3. Warranty repairs must be carried out by Authorised Samsung Dealers or Authorised Service Centres. No re-imbursment will be made for repairs carried out by non Samsung Dealers and, any such repair work and damage to the products caused by such repair work will not be covered by this warranty.



**REPUBLIC OF
IRELAND**

4. This product is not considered to be defective in materials nor workmanship by reason that it requires adaptation in order to conform to national or local technical or safety standards in force in any Country other than the one for which the product was originally designed and manufactured. This warranty will not cover, and no re-imbursment will be made for such adaptation nor any damage which may result.

5. This warranty covers none of the following:
 - a) Periodic check ups, maintenance and repair or replacement of parts due to normal wear and tear.
 - b) Cost relating to transport, removal or installation of the product.
 - c) Misuse, including the failure to use this product for its normal purposes or incorrect installation.
 - d) Damage caused by Lightning, Water, Fire, Acts of God, War, Public Disturbances, incorrect mains voltage, improper ventilation or any other cause beyond the control of Samsung.
6. This warranty is valid for any person who legally acquired possession of the product during the warranty period.
7. The consumers statutory rights in any applicable national legislation whether against the retailer arising from the purchase contract or otherwise are not affected by this warranty. Unless there is national legislation to the contrary, the rights under this warranty are the consumers sole rights and Samsung, its subsidiaries and distributors shall not be liable for indirect or consequential loss or any damage to records, compact discs, videos or audio tape or any other related equipment or material.

SAMSUNG ELECTRONICS (U.K.) LTD.

THIS APPLIANCE IS DISTRIBUTED BY

