

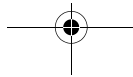

Veriton FP series User's guide

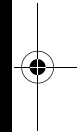

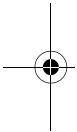
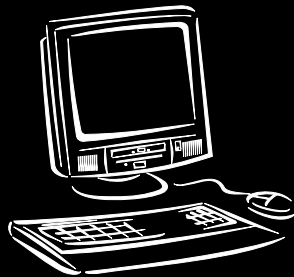
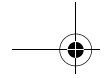

Copyright © 1999 Acer Incorporated
All Rights Reserved.

Veriton FP series
User's guide

Changes may be made periodically to the information in this publication without obligation to notify any person of such revision or changes. Such changes will be incorporated in new editions of this manual or supplementary documents and publications. This company makes no representations or warranties, either expressed or implied, with respect to the contents hereof and specifically disclaims the implied warranties of merchantability or fitness for a particular purpose.

Record the model number, serial number, purchase date, and place of purchase information in the space provided below. The serial number and model number are recorded on the label affixed to your computer. All correspondence concerning your unit should include the serial number, model number, and purchase information.

No part of this publication may be reproduced, stored in a retrieval system, or transmitted, in any form or by any means, electronic, mechanical, photocopy, recording, or otherwise, without the prior written permission of Acer Incorporated.

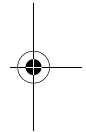
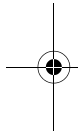

Model Number : _____

Serial Number: _____

Purchase Date: _____

Place of Purchase: _____

Acer and the Acer Logo are registered trademarks of Acer Inc. Other company's product names or trademarks are used herein for identification purposes only and belong to their respective companies.

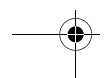
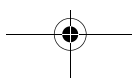



Notices

FCC notice

This device has been tested and found to comply with the limits for a Class B digital device pursuant to Part 15 of the FCC Rules. These limits are designed to provide reasonable protection against harmful interference in a residential installation. This device generates, uses, and can radiate radio frequency energy and, if not installed and used in accordance with the instructions, may cause harmful interference to radio communications.

However, there is no guarantee that interference will not occur in a particular installation. If this device does cause harmful interference to radio or television reception, which can be determined by turning the device off and on, the user is encouraged to try to correct the interference by one or more of the following measures:

- Reorient or relocate the receiving antenna
- Increase the separation between the device and receiver
- Connect the device into an outlet on a circuit different from that to which the receiver is connected
- Consult the dealer or an experienced radio/television technician for help

Notice: Shield cables

All connections to other computing devices must be made using shielded cables to maintain compliance with FCC regulations.

Notice: Peripheral devices

Only peripherals (input/output devices, terminals, printers, etc.) certified to comply with the Class B limits may be attached to this equipment. Operation with noncertified peripherals is likely to result in interference to radio and TV reception.



.....
Caution! Changes or modifications not expressly approved by the manufacturer could void the user's authority, which is granted by the Federal Communications Commission, to operate this computer.



Use conditions

This part complies with Part 15 of the FCC Rules. Operation is subject to the following two conditions: (1) this device may not cause harmful interference, and (2) this device must accept any interference received, including interference that may cause undesired operation.

Notice: Canadian users

This Class B digital apparatus meets all requirements of the Canadian Interference-Causing Equipment Regulations.

Remarque à l'intention des utilisateurs canadiens

Cet appareil numérique de la classe B respecte toutes les exigences du Règlement sur le matériel brouilleur du Canada.

Important safety instructions

Read these instructions carefully. Save these instructions for future reference.

1. Follow all warnings and instructions marked on the product.
2. Unplug this product from the wall outlet before cleaning. Do not use liquid cleaners or aerosol cleaners. Use a damp cloth for cleaning.
3. Do not use this product near water.
4. Do not place this product on an unstable cart, stand, or table. The product may fall, causing serious damage to the product.
5. Slots and openings in the cabinet and the back or bottom are provided for ventilation; to ensure reliable operation of the product and to protect it from overheating, these openings must not be blocked or covered. The openings should never be blocked by placing the product on a bed, sofa, rug, or other similar surface. This product should never be placed near or over a radiator or heat register, or in a built-in installation unless proper ventilation is provided.
6. This product should be operated from the type of power indicated on the marking label. If you are not sure of the type of power available, consult your dealer or local power company.

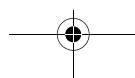
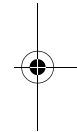
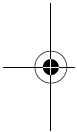



7. Do not allow anything to rest on the power cord. Do not locate this product where persons will walk on the cord.
8. If an extension cord is used with this product, make sure that the total ampere rating of the equipment plugged into the extension cord does not exceed the extension cord ampere rating. Also, make sure that the total rating of all products plugged into the wall outlet does not exceed the fuse rating.
9. Never push objects of any kind into this product through cabinet slots as they may touch dangerous voltage points or short out parts that could result in a fire or electric shock. Never spill liquid of any kind on the product.
10. Do not attempt to service this product yourself, as opening or removing covers may expose you to dangerous voltage points or other risks. Refer all servicing to qualified service personnel.
11. Unplug this product from the wall outlet and refer servicing to qualified service personnel under the following conditions:
12. When the power cord or plug is damaged or frayed
 - a. If liquid has been spilled into the product
 - b. If the product has been exposed to rain or water
 - c. If the product does not operate normally when the operating instructions are followed. Adjust only those controls that are covered by the operating instructions since improper adjustment of other controls may result in damage and will often require extensive work by a qualified technician to restore the product to normal condition.
 - d. If the product has been dropped or the cabinet has been damaged
 - e. If the product exhibits a distinct change in performance, indicating a need for service.
 - f. Replace the battery with the same type as the product's battery we recommend. Use of another battery may present a risk of fire or explosion. Refer battery replacement to a qualified serviceman.

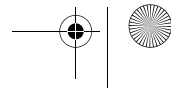
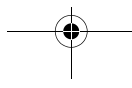
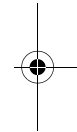
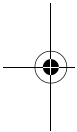

13. **Warning!** Batteries may explode if not handled properly. Do not disassemble or dispose of them in fire. Keep them away from children and dispose of used batteries promptly.
14. Use only the proper type of power supply cord set (provided in your accessories box) for this unit. It should be a detachable type: UL listed/CSA certified, type SPT-2, rated 7A 125V minimum, VDE approved or its equivalent. Maximum length is 15 feet (4.6 meters).

Year 2000 compliance statement

The Veriton FP Series computer carries the "Hardware NSTL Tested Year 2000 Compliant" logo, which certifies that this model has been tested by NSTL using the YMark2000 test, and has been found to meet NSTL's standards for Year 2000 hardware compliance.



For more details, check the Acer Year 2000 Resource Center at <http://www.acer.com/service/y2k/index.htm>

Laser compliance statement

The CD-ROM drive in this computer is a laser product. The CD-ROM drive's classification label (shown below) is located on the drive.

CLASS 1 LASER PRODUCT

CAUTION: INVISIBLE LASER RADIATION WHEN OPEN. AVOID EXPOSURE TO BEAM.

APPAREIL A LASER DE CLASSE 1 PRODUIT

LASERATTENTION: RADIATION DU FAISCEAU LASER INVISIBLE EN CAS D'OUVERTURE. EVITER TOUTE EXPOSITION AUX RAYONS.

LUOKAN 1 LASERLAITE LASER KLASSE 1

VORSICHT: UNSICHTBARE LASERSTRAHLUNG, WENN ABDECKUNG GEÖFFNET NICHT DEM STRAHL AUSSETZEN



PRODUCTO LÁSER DE LA CLASE I

ADVERTENCIA: RADIACIÓN LÁSER INVISIBLE AL SER ABIERTO. EVITE EXPONERSE A LOS RAYOS.

ADVARSEL: LASERSTRÅLING VEDÅBNING SE IKKE IND I STRÅLEN

VARO! LAVATTAESSA OLET ALTTINA LASERSÄTEILYLLE.

WARNING: LASERSTRÅLNING NÅR DENNA DEL ÅR ÖPPNAD ÅLÅ TUIJOTA SÄTEESEENSTIRRA EJ IN I STRÅLEN

WARNING: LASERSTRÅLNING NAR DENNA DEL ÅR ÖPPNADSTIRRA EJ IN I STRÅLEN

ADVARSEL: LASERSTRÅLING NAR DEKSEL ÅPNESSTIRR IKKE INN I STRÅLEN

Lithium battery statement

CAUTION

Danger of explosion if battery is incorrectly replaced. Replace only with the same or equivalent type recommended by the manufacturer. Discard used batteries according to the manufacturer's instructions.

ADVARSEL!

Lithiumbatteri - Eksplosjonsfare ved feilagtig håndtering. Udsiftning må kun ske med batteri af samme fabrikat og type. Léver det brugte batteri tilbage til leverandøren.

ADVARSEL

Eksplosjonsfare ved feilaktig skifte av batteri. Benytt samme batteritype eller en tilsvarende type anbefalt av apparatfabrikanten. Brukte batterier kasseres i henhold til fabrikantens instruksjoner.

WARNING

Explosionsfara vid felaktigt batteribyte. Använd samma batterityp eller en ekvivalent typ som rekommenderas av apparattillverkaren. Kassera använt batteri enligt fabrikantens instruktion.

VAROITUS

Päristo voi räjähtää, jos se on virheellisesti asennettu. Vaihda paristo ainoastaan laitevalmistajan suosittelemaan tyyppiin. Hävitä käytetty paristo valmistajan ohjeiden mukaisesti.

VORSICHT!

Explosionsgefahr bei unsachgemäßen Austausch der Batterie Ersatz nur durch denselben oder einem vom Hersteller empfohlenem ähnlichen Typ. Entsorgung gebrauchter Batterien nach Angaben des Herstellers.

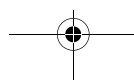
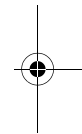
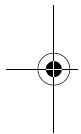

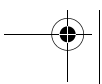
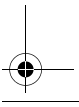
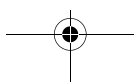
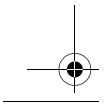
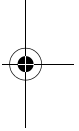
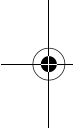
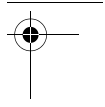
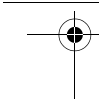
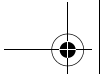

Contents

▶ Notices	iii
FCC notice	iii
Important safety instructions	iv
Year 2000 compliance statement	vi
Laser compliance statement	vi
Lithium battery statement	vii
1 Overview	1
Package contents	3
Taking care of your computer	4
Important tips	4
Cleaning and servicing	4
2 System tour	7
Features	9
Front panel	11
Ports	12
Left panel	13
Right panel	15
Keyboard	16
Cursor keys	16
Lock keys	16
Windows keys	17
Mouse	18
Disk drives	19
3.5-inch floppy disk drive	19
CD-ROM drive	19
Hard disk drive	21
3 Setting up your computer	23
Arranging a comfortable work area	25
Adjusting your chair	25
Positioning your keyboard	25
Positioning your mouse	26
Positioning your LCD PC	26
Connecting peripherals	27
Mouse	27
Keyboard	28
Power cable	29
Turning on your computer	30
Turning off your computer	31

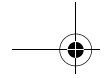

4 Adding options to your computer	33
Removing the side panel cover	35
Connecting an external monitor	36
Connecting a serial mouse	37
Connecting a printer	38
Connecting to the network	39
Setting up a modem (optional)	40
Connecting multimedia devices	41
Connecting USB devices	42
Upgrading your computer	43
5 Software	45
Easy Networking	48
TimeMachine	49
PC-cillin	50
PC-Doctor	51
ASM Pro Suite	52
Reinstalling applications	54
6 Q & A	55

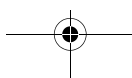
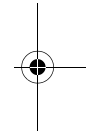
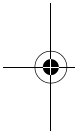

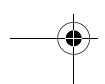
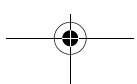
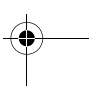
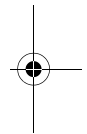
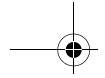

1 Overview

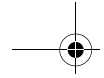

This product combines the power of a conventional desktop PC with the versatility of a portable computer. It supports a high-end Pentium® III processor and a host of features to help you work with unmatched productivity and ease.

This chapter gives an overview of the product and the peripherals that come with it.

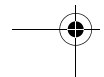
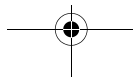
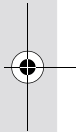
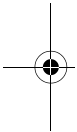

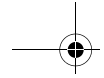

► Package contents

Before you unpack your computer, make sure that you have enough space to set up your computer.

Carefully unpack the carton and remove the contents. If any of the following items are missing or damaged, contact your dealer immediately:

- Veriton FP
- PS/2 keyboard
- PS/2 mouse
- Power cable
- User's guide
- Other user documentation and third-party software

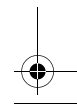
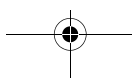
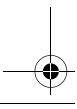
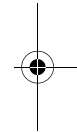
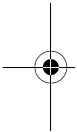



▶ Taking care of your computer

Please read the important instructions listed in this section. Following these instructions will help you maximize the durability of your computer.

Important tips

- Do not expose the computer to direct sunlight. Do not place it near sources of heat, such as a radiator.
- Do not subject the computer to magnetic fields.
- Do not expose the computer to rain or moisture.
- Do not spill water on the computer.
- Do not subject the computer to heavy shock or vibration.
- Do not expose the computer to dust and dirt.
- Never place the system on uneven surfaces.
- Do not step on the power cord or place heavy objects on top of it. Carefully route the power cord and any cables away from personal traffic.
- When unplugging the power cord, do not pull on the cord itself but pull on the plug.
- The total ampere rating of the equipment plugged in should not exceed the ampere rating of the cord if you are using an extension cord. Also, the total current rating of all equipment plugged into a single wall outlet should not exceed the fuse rating.
- Check the documentation that came with your software programs to see if you can select other combinations of resolution and color. These adjustments could make viewing the screen more comfortable.

Cleaning and servicing

To clean your computer and keyboard

1. Turn off the computer and unplug the power cord.

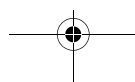
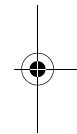
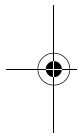

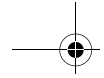

2. Use a soft cloth moistened with water and gently wipe the exterior of the computer and the keyboard. Do not use liquid or aerosol cleaners.

To clean your mouse

1. Open the circular cover underneath the mouse.
2. Take out the rubber ball and wipe it with a soft, damp cloth.
3. Put the ball back and close the cover.

When to contact a service technician

- If you dropped and damaged the computer.
- If liquid has been spilled into the computer.
- If the computer is not operating normally.

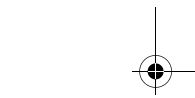
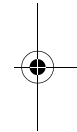
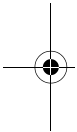

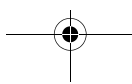
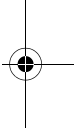
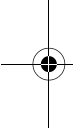
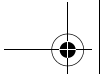

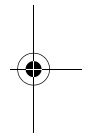
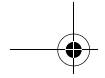

2 System tour

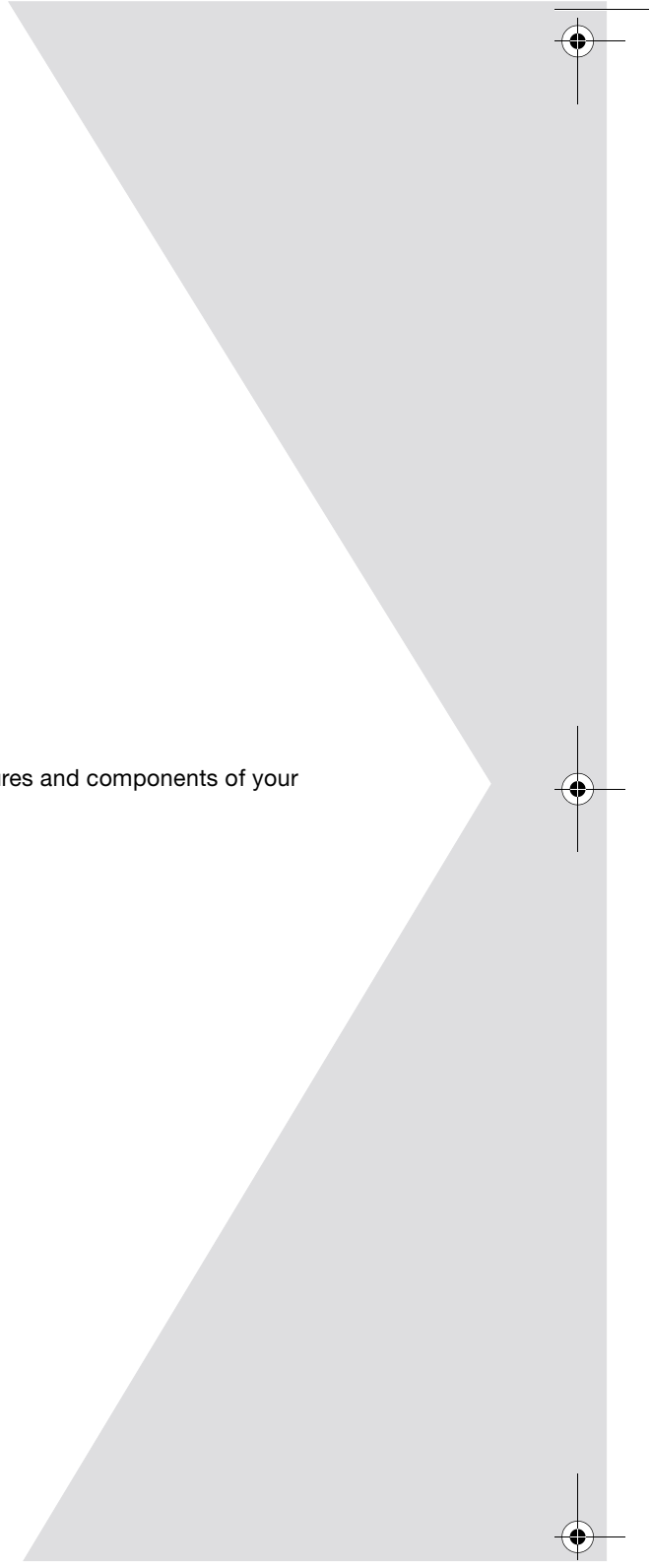
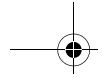

This chapter discusses the features and components of your computer.

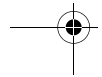
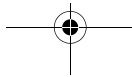
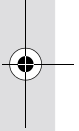
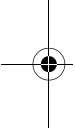



► Features

Here are just a few of your computer's many features:

Performance

- Intel Pentium® III processor with integrated L2 cache memory
- Expandable system memory to a maximum of 256 MB
- Power management function
- 15-inch Large Super Thin-Film-Transistor (TFT) eXtended Graphics Array (XGA) Liquid Crystal Display (LCD)
- 3.5-inch floppy disk drive
- CD-ROM drive
- High-capacity, Enhanced-IDE hard disk
- PS/2 mouse and keyboard interface

Multimedia

- 64-bit graphics acceleration with 8-MB graphics memory and Accelerated Graphics Port (AGP) support
- 10Base-T/100Base-TX network support with remote wake-up function
- 16-bit high-quality audio system via onboard PCI audio controller
- Built-in speakers
- Line-in, Line-out, Mic-in, and Game/MIDI interfaces

Connectivity

- Fast infrared (FIR) wireless communication
- Universal Serial Bus (USB) ports
- External VGA port for simultaneous LCD and Cathode Ray Tube (CRT) display support
- High-speed fax/data PCI modem (optional)

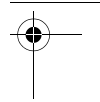
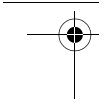
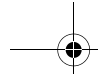

Human-centric design and ergonomics

- Slim, smooth and stylish design
- Adjustable rotary stand

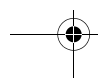
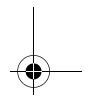
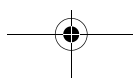
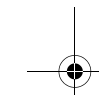
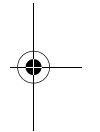
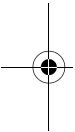

► Front panel

Your computer's front panel consists of the following:

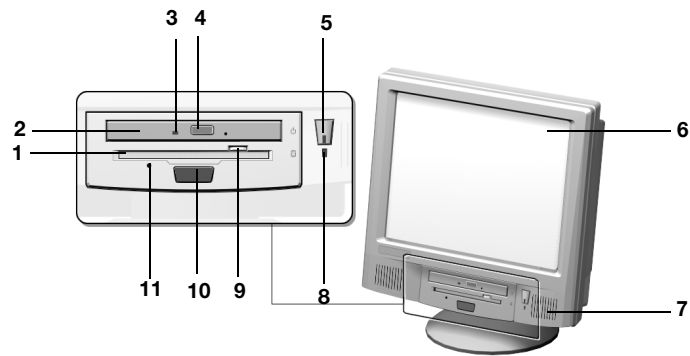

Label	Description
1	3.5-inch floppy disk drive
2	CD-ROM drive
3	CD-ROM activity LED
4	CD-ROM eject button
5	Power button
6	15-inch TFT LCD display
7	Built-in speakers
8	Hard disk drive LED display
9	3.5-inch floppy disk drive eject button
10	FIR port for wireless communication support
11	3.5-inch floppy disk drive activity light emitting diode (LED)

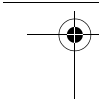

▶ Ports

Your computer offers several ports that allow you to connect peripheral devices. These ports are found on the left and right panels of your computer.

For information on how to connect the peripherals, see “Connecting peripherals” on page 27 and “Adding options to your computer” on page 33.

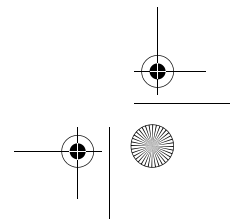
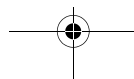
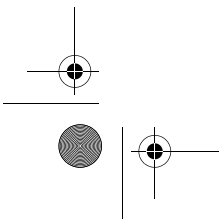
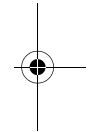
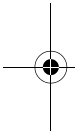



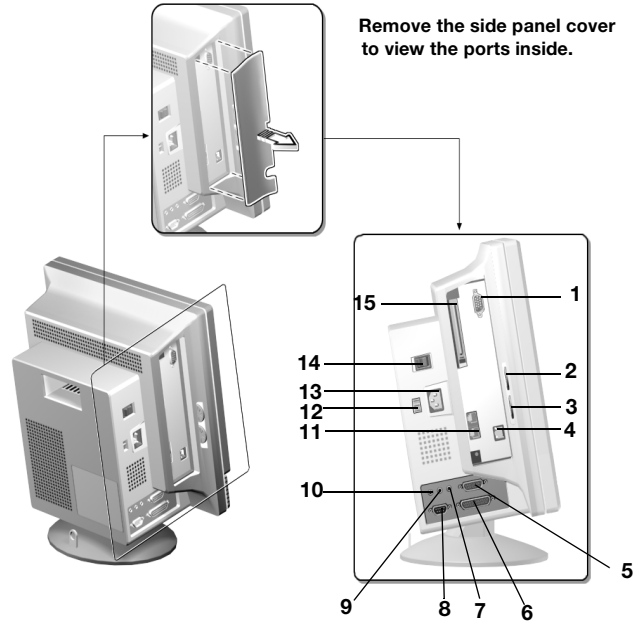





Left panel



Note: For instructions on how to remove the side panel cover, see "Removing the side panel cover" on page 35.



Label	Icon	Color	Description
1		Blue	External monitor port
2			Brightness control
3			Volume control

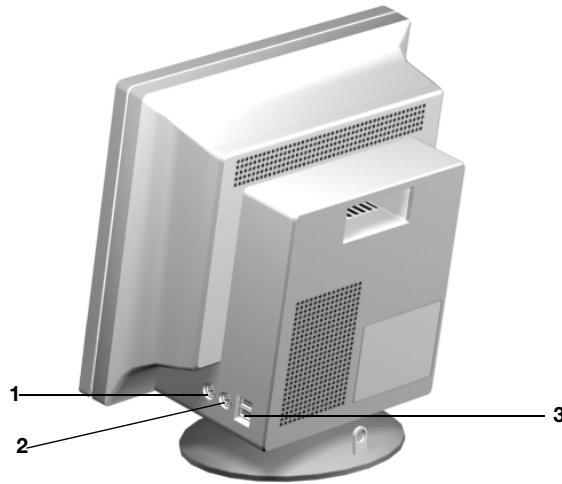

Label	Icon	Color	Description
4			Network port
5		Gold	Game/MIDI port
6		Burgundy	Parallel/printer port
7		Lime	Line-out port
8		Teal or Turquoise	Serial port
9		Light blue	Line-in port
10		Pink	Microphone-in port
11	 		Fax/modem ports (optional)
12			Voltage selector switch
13			Power cord socket
14			Main power switch
15			Expansion slot

Right panel



Label	Icon	Color	Description
1		Purple	PS/2 keyboard port
2		Green	PS/2 mouse port
3		Black	USB ports

► Keyboard

The keyboard that came with your computer has full-sized keys that include separate cursor keys, two Windows keys, and twelve function keys.

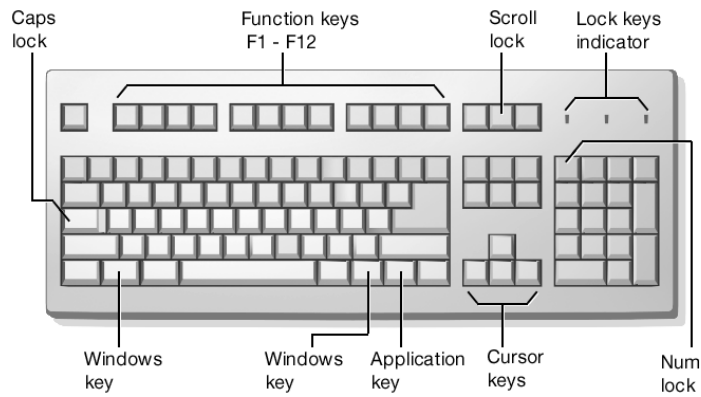

Cursor keys

The cursor keys, also called the arrow keys, let you move the cursor around the screen. They serve the same function as the arrow keys on the numeric keypad when the Num Lock is toggled off.

Lock keys



The keyboard has three lock keys which you can toggle on and off to switch between two functions.

Lock Key	Description
Caps Lock	When activated, all alphabetic characters typed appear in uppercase (same function as pressing Shift + <letter>).

Lock Key	Description
Num Lock	When activated, the keypad is set to numeric mode, i.e., the keys function as a calculator (complete with arithmetic operators such as +, -, x, and /).
Scroll Lock	When activated, the screen moves one line up or down when you press the up arrow or down arrow respectively. Take note that Scroll Lock may not work with some applications.

Windows keys

The keyboard has two keys that perform Windows-specific functions.

Key	Description
Windows logo key 	Start button. Combinations with this key perform special functions, such as: <ul style="list-style-type: none"> • Windows + Tab: Activate the next Taskbar button • Windows + E: Explore My Computer • Windows + F: Find Document • Windows + M: Minimize All • Shift + Windows + M: Undo Minimize All • Windows + R: Display Run dialog box
Application key 	Opens the applications context menu (same function as clicking the right button of the mouse).



▶ Mouse

Your mouse has one ratchet wheel and two buttons: a left button and a right button. Quickly pressing and releasing the buttons is called clicking. Sometimes, you will need to do a double-click (clicking the same button twice quickly) or a right-click (clicking the right button quickly).

The ratchet wheel in between the two buttons is added to provide easier scrolling capability. By simply moving the wheel with your index finger, you can quickly move through multiple pages, lines, or windows. The wheel may also function as a third button allowing you to quickly click or double-click an icon or a selected item.

For information on how to clean your mouse, see “To clean your mouse” on page 5.

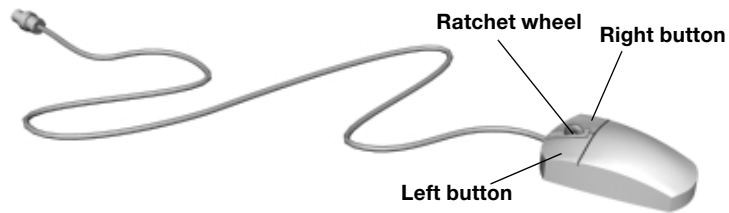

Note: If you are left-handed, refer to your Windows manual for instructions on how to set up your mouse for left-handed use.

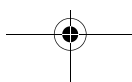

► Disk drives

Your computer comes with the following disk drives.

3.5-inch floppy disk drive

Your computer's 3.5-inch floppy disk drive can handle 720-KB and 1.44-MB capacity diskettes.

The floppy diskettes are compact, lightweight, and easy to carry around. Here are some tips on how to take care of your diskettes:

- Always make backup copies of the diskettes that contain important data or program files.
- Keep diskettes away from magnetic fields and sources of heat.
- Avoid removing a diskette from a drive when the floppy drive activity light is on.
- Write-protect your diskettes to prevent accidental erasure. To do this, slide the write-protect tab to the write-protect position.

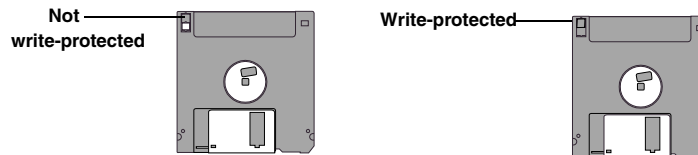

- When you put a label on a 3.5-inch diskette, make sure that the label is properly attached (flat on the surface) and within the labeling area (area with a slight surface depression) on the diskette. An improperly attached label may cause a diskette to get stuck in a drive when you are inserting or removing it.

CD-ROM drive

Your CD-ROM drive, located on the front panel of your computer, allows you to play different types of Compact Discs (CDs). CDs, like diskettes, are also compact, lightweight, and easy to carry around. However, they are more delicate than diskettes and must be handled with extra care.

To insert a CD into your computer's CD-ROM drive:

1. Gently push the eject button located on the front panel.

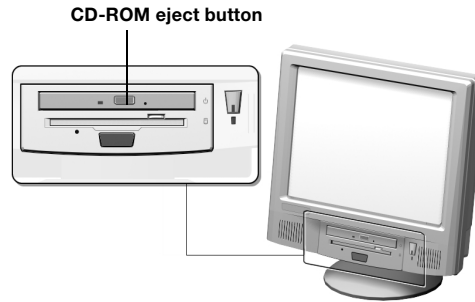

2. When the CD tray slides open, pull the tray out using your finger.
3. Insert the CD. Make sure that the label or title side of the CD is facing upward.



.....
Caution! Hold the CD by the edges to avoid leaving smudges or fingerprints.



4. Gently press the CD down to make sure that it is properly inserted.



.....
Caution! While pressing the CD, be careful not to bend the CD tray. Make sure that the CD is properly inserted before closing the CD tray. Improper insertion may damage both the CD and the CD-ROM drive.

5. Gently close the tray.

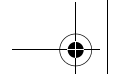

To take care of your CDs:

- Keep your CDs in a disk case when not in use to avoid scratches or other damage. Any kind of dirt or damage can affect the data on the disc, impair the disc lens reader on the CD-ROM drive, or stop the computer from successfully reading the disc.
- When handling CDs, always hold them by the edges to avoid smudges or fingerprints.
- When cleaning CDs, use a clean, dust-free cloth and wipe in a straight line from the center to the edge. Do not wipe in a circular motion.
- Clean your CD-ROM drive periodically. You may refer to the Cleaning Kit for instructions. Cleaning Kits can be purchased in any computer or electronics shop.

Hard disk drive

Your computer is preinstalled with a high-capacity Enhanced-IDE (E-IDE) hard disk drive. If you want to replace your hard disk or upgrade it, contact your dealer or a qualified service technician for support.

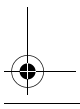
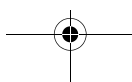
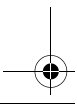
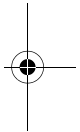
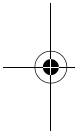

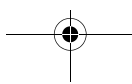
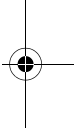
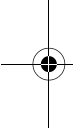
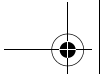

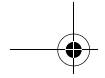

3 Setting up your computer

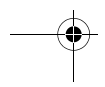
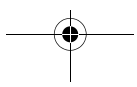
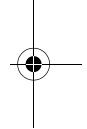

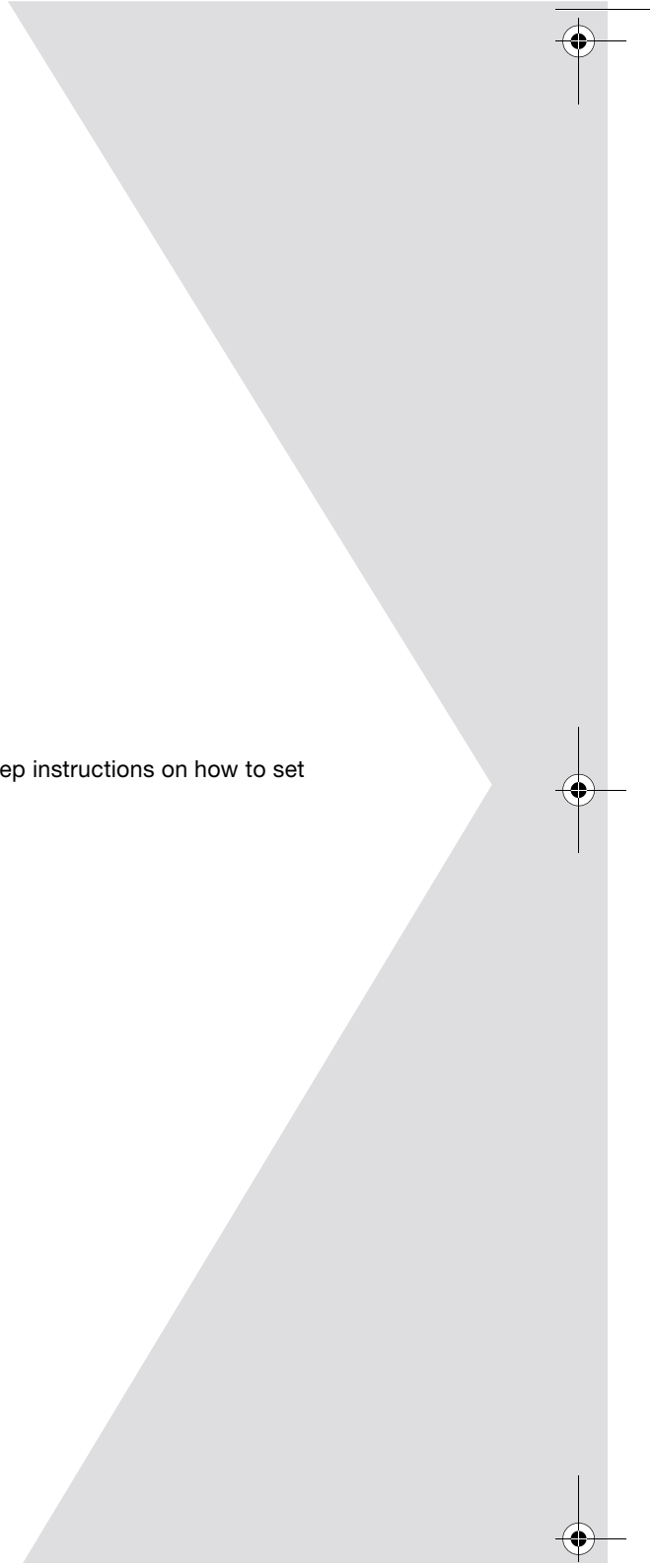

This chapter contains step-by-step instructions on how to set up your computer.

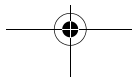
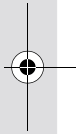
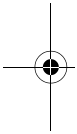



▶ Arranging a comfortable work area

Working safely begins with the arrangement of your work space and the proper use of equipment. For this reason, it is very important to take time and think about how you are going to arrange your work area.

Here are some points to consider:

Adjusting your chair

Having the right kind of chair does not necessarily mean that you'll be properly supported. It is necessary to adjust your chair to fit your body. Proper body posture will make you more comfortable and productive.

- Avoid tilting your chair. If you have a chair that tilts, lock those tilt knobs so that your chair will not tilt forward or backward while you are using your computer.
- Adjust your chair height in such a way that you can sit on it with your thighs parallel to the floor and your feet resting flat on the floor.
- Rest your body on the chair back. Your torso works harder to maintain balance if you do not rest your body on the chair back.

Positioning your keyboard

The location of the keyboard is a very important factor to your posture. Placing it too far will make your body lean forward forcing you to sit in an unnatural position. Placing it too high will add tension to your shoulder muscles.

- The keyboard should be placed just above your lap. Adjust the keyboard height by flipping the folding stands located under the keyboard.
- Keep your lower arms parallel to the floor as you type. Your upper arms and shoulders should be relaxed. Then try typing with a light touch. If you feel any shoulder or neck strain, stop for a while and check your posture.
- Position your keyboard in front of your monitor. Putting your keyboard beside your monitor will make you turn your head while you

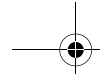

type which could add tension to your neck muscles that may later result in neck strain.

Positioning your mouse

- The mouse should be placed on the same surface as your keyboard so that you can reach it with ease.
- Adjust its position to allow enough space for movement without making you stretch or lean over.
- Use your arm to move the mouse. Do not rest your wrist on the table when moving the mouse.

Positioning your Veriton FP

Place the Veriton FP at a comfortable viewing distance, usually 50 to 60 centimeters away. Adjust the display in such a way that the top of the screen is at or slightly below eye level.

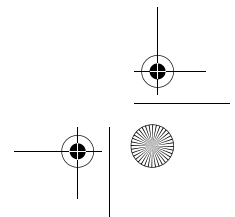
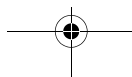
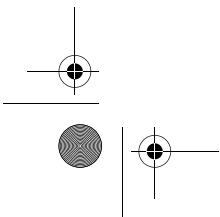
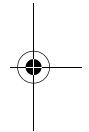
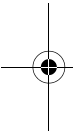

▶ Connecting peripherals

Setting up your computer is easy. For the most part, you only have three things to connect: the mouse, the keyboard, and the power cable.

Mouse

Plug the mouse cable into the PS/2 mouse port  (green port) located on the right panel of your computer.

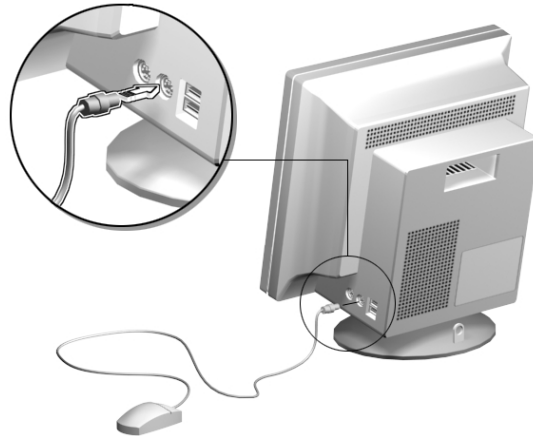

Keyboard

Plug the keyboard cable into the PS/2 keyboard port  (purple port) located on the right panel of your computer.

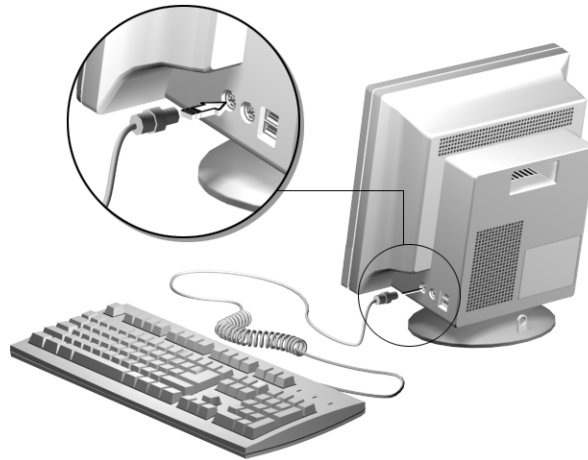

Power cable



Caution! Before you proceed, check the voltage range in your area. Make sure that it matches your computer's voltage setting (see the voltage setting switch located on the left panel of your computer). If they don't match, change your computer's voltage setting according to your area's voltage range.

Plug the power cable into the power cable socket located on the left panel of your computer. Then plug the other end of the power cable into a power outlet.

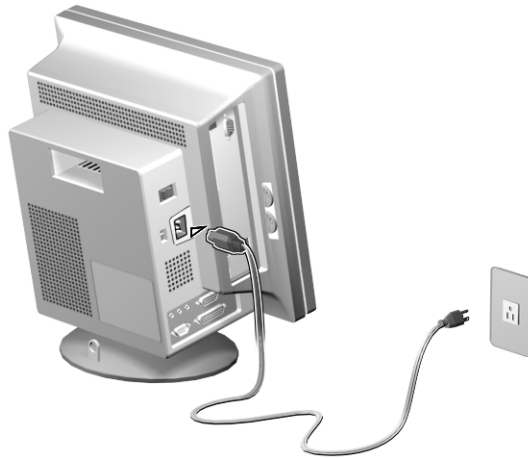

▶ Turning on your computer

After connecting the necessary peripherals and plugging in the power cable, you are now ready to turn the computer on and get to work.

To turn on your computer:

1. Locate and turn on (1) the main power switch on the left panel of your computer.
2. On the front panel of your computer, press the power button.



Important: Make sure that the power cable is properly plugged into an electrical outlet. If you are using a power strip or an AVR (Auto-Voltage Regulator), make sure that it is plugged in and turned on.



► Turning off your computer

To turn off your computer, do either of the following:

- From your Windows desktop, click on **Start, Shut Down...** and select **Shut down**; then click on **OK**.
- Turn off all peripherals connected to your computer, and then, press the power button for at least four seconds. Quickly pressing the button may put the computer in Suspend mode only.



.....
Note: You do not need to turn off the main power switch every time you turn off your computer. Turn off the main power switch only if:
- you will not use your computer for a long time or
- your computer needs servicing.

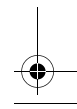
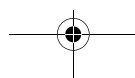
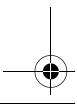
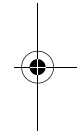
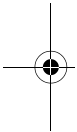

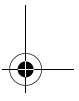
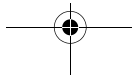
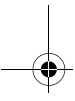
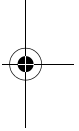
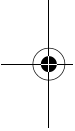
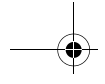

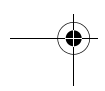
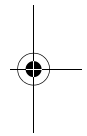
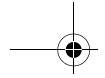

4 Adding options to your computer

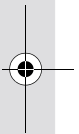
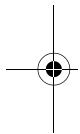

Aside from the mouse and keyboard, you can also connect additional peripherals to your computer. This chapter will tell you how to connect additional peripherals and what to do if you want to upgrade your computer.

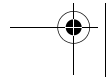
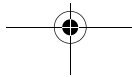

► Removing the side panel cover

You need to remove the side panel cover before you can connect additional peripherals to your computer; otherwise, you won't be able to access the ports.

To remove the side panel cover:

1. Insert your finger into the hole provided on the lower part of the side panel cover.
2. Pull out the cover.

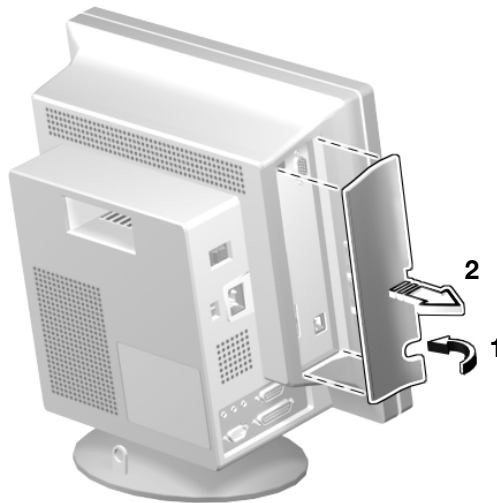

▶ Connecting an external monitor

Your computer supports simultaneous CRT and LCD display. To connect an external monitor, simply plug the monitor cable into the external monitor port  (blue port) located on the left panel of your computer.

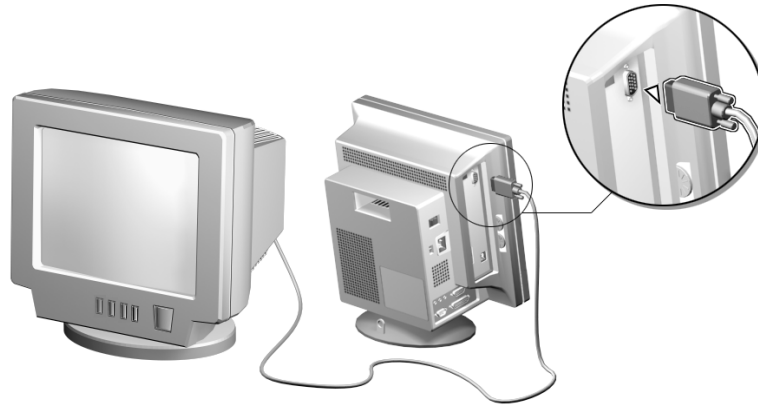

Note: Refer to the monitor manual for additional instructions and information.



▶ Connecting a serial mouse

You can also connect a serial mouse to your computer. To connect one, simply plug the mouse cable into the serial port  (teal or turquoise port) located on the left panel of your computer.

To enable the serial mouse, use the Add New Hardware tool in the Windows Control Panel. Refer to your Windows manual for more information.

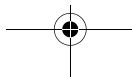
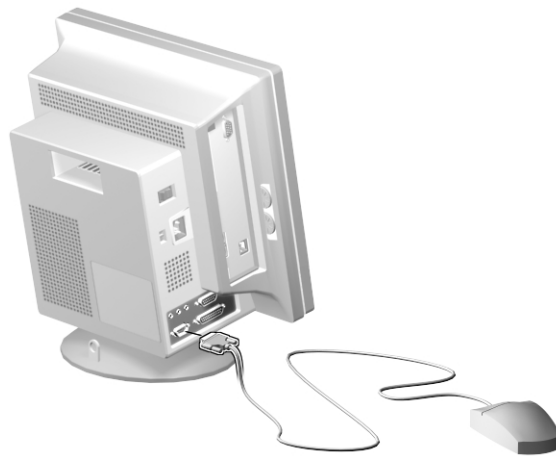

▶ Connecting a printer

Your computer supports both serial and parallel printers.

To connect a parallel printer, plug the printer cable into the parallel port  (burgundy port) located on the left panel of your computer.

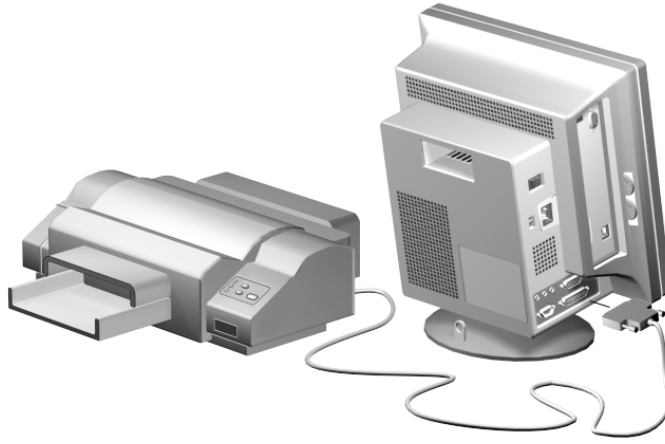

To connect a serial printer, plug the printer cable into the serial port  (teal or turquoise port) located on the left panel of your computer. See “Left panel” on page 13 for the location of the serial port.

▶ Connecting to the network

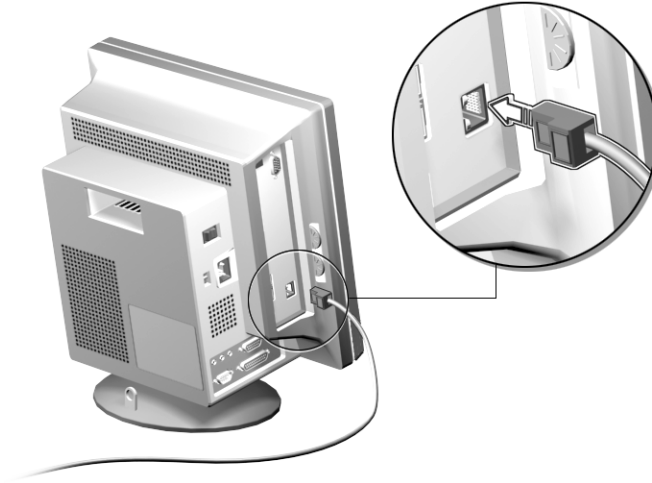

You can connect your computer to a Local Area Network (LAN) using a network cable. To do so, simply plug the network cable into the network port  on the left panel of your computer.



Note: Consult your operating system manual for information on how to configure your network setup.



► Setting up a modem (optional)

Set up your modem connection by plugging the telephone line  and handset  into their correspond ports on the left panel of your computer.

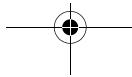
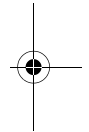
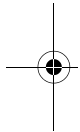
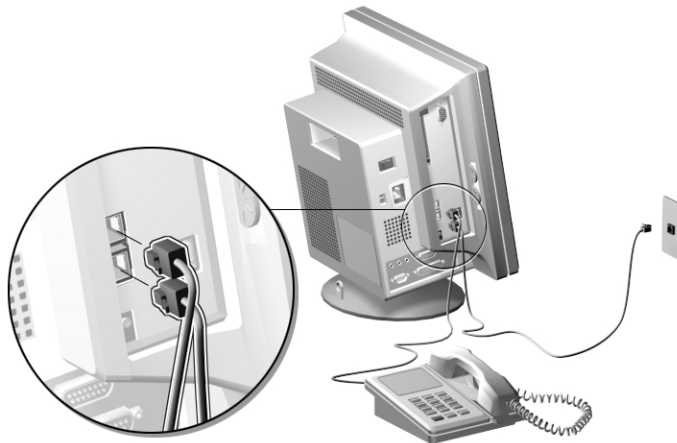

Refer to the figure below for the connections.



▶ Connecting multimedia devices

You can connect multimedia devices such as speakers, a microphone, headphones or earphones and a joystick (for games). These devices will allow you to take advantage of your computer's multimedia features.

Plug the devices in as follows:

- microphone: connect to Mic-in port  (pink port)
- speakers, earphones, headphones: connect to Line-out port  (lime port)
- joystick: connect to Game/MIDI port  (gold port)

Refer to the figure below for the connections.

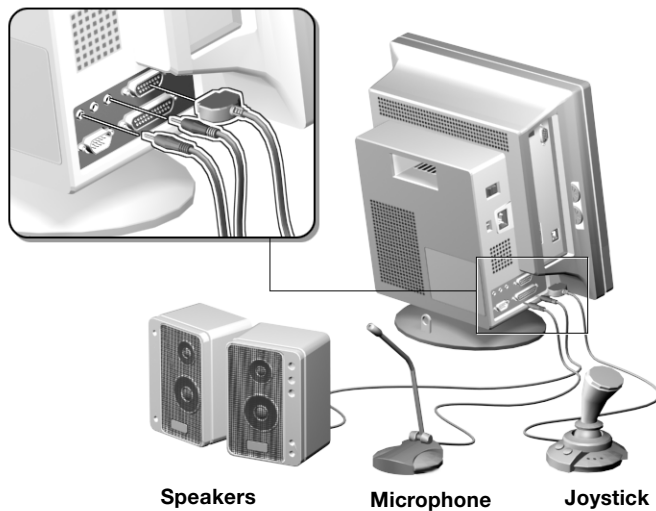

Note: For information on how to configure the multimedia devices, consult the documentation that came with each device.

▶ Connecting USB devices

Universal Serial Bus (USB) is a new serial bus design that is capable of cascading low-/medium-speed peripherals (less than 12 Mbps) such as a keyboard, mouse, joystick, scanner, printer and modem. With USB, complex cable connections can be eliminated.

Your computer comes with two USB ports located on the right panel. These ports allow you to connect additional serial devices to your computer without using up its system resources.

To connect a USB device, simply plug the device cable into either of the USB ports  (black port) on the right panel.

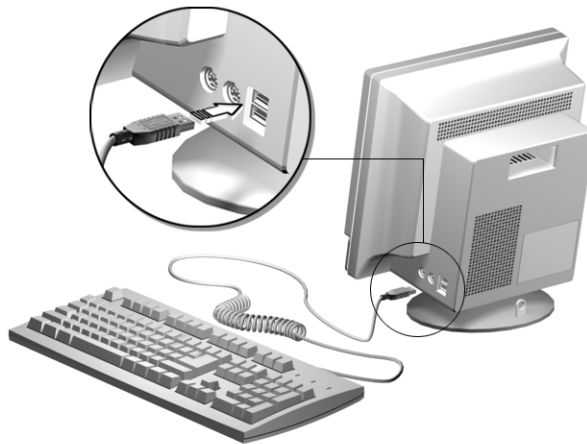

Note: Most USB devices have a built-in USB port which allows you to daisy-chain other devices.

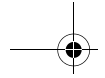

► Upgrading your computer

Certain aspects of your computer are upgradable such as the memory, hard disk, and the expansion card. However, for safety purposes, we do not want you to perform these upgrades. Contact your dealer if you wish to upgrade your computer or replace components.

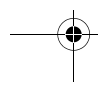
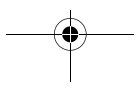
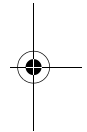
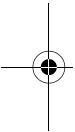

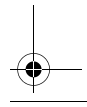
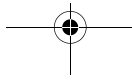
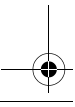
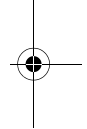
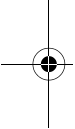
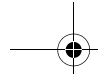

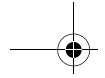

5 Software

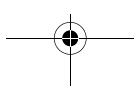
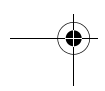
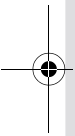
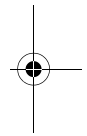

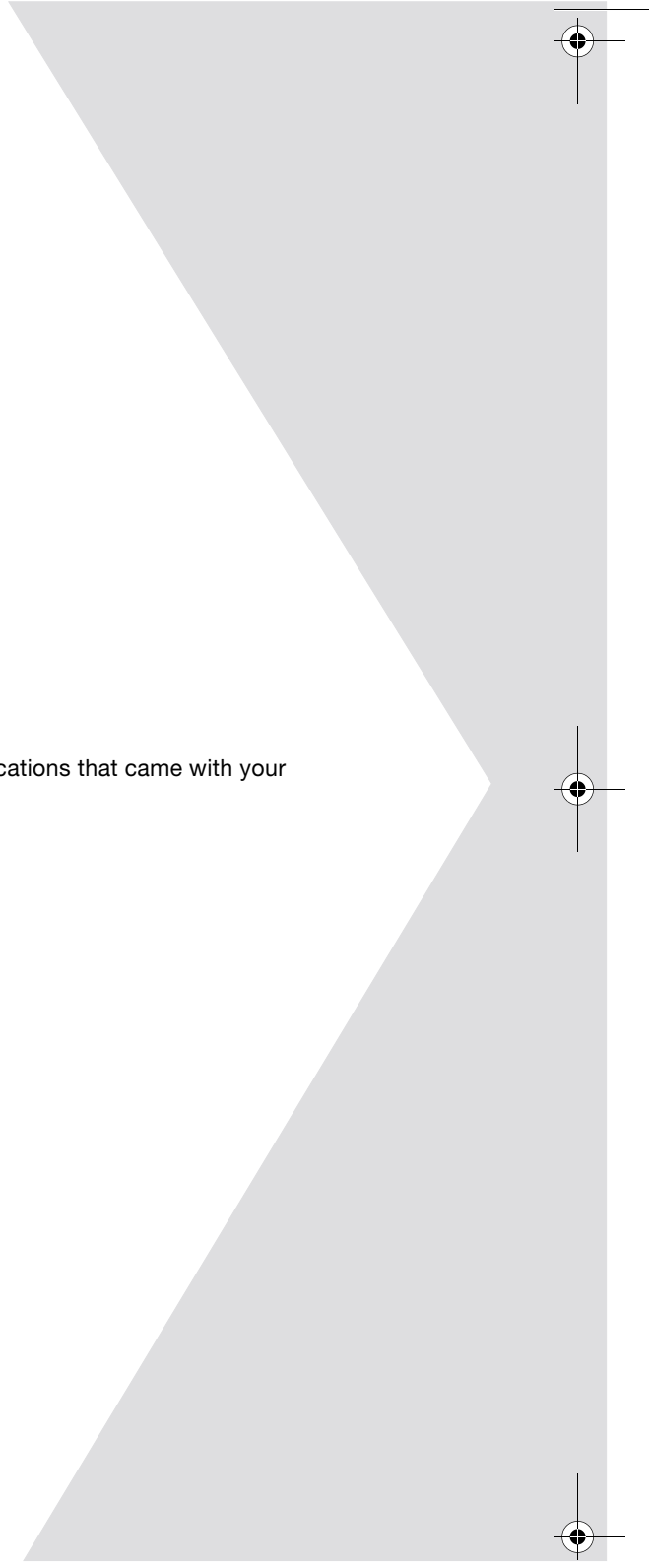
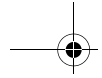

This chapter describes the applications that came with your computer.

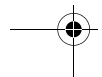
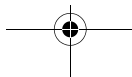
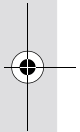
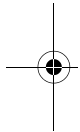

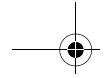

Your computer comes with the following applications:

- Easy Networking
- TimeMachine
- PC-cillin
- PC Doctor
- ASM Pro Suite

All of the applications that came with your computer are very easy to use. However, if you need more help and information, you may refer to the online help documentation provided in each software application.

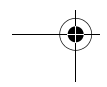
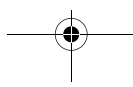
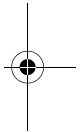
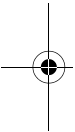



► Easy Networking

Easy Networking is a wizard-like utility that helps you set up network components, such as TCP/IP, IPX, NetBEUI, Client for Microsoft NT, Client for Novell NetWare, and File/Print sharing for Microsoft, quickly and conveniently for network connection by yourself. Before you proceed with the installation, make sure you have the following information:

- supported network protocol
- supported network client and services
- your computer's Internet Protocol (IP) address
- your workgroup's name

If you do not know where to get this information, you may ask your network administrator. Once you have this data, all you need to do is simply follow the utility's step-by-step Graphical User Interface (GUI). When you are done with the installation and restart your computer, a diagnostics utility checks your network setup to make sure that each component is working properly.

Easy Networking is much less complicated and easier to use compared to other networking utilities available in today's market. It uses only the most commonly-used industry-standard protocols and network services.

To run this utility, simply click on the **EasyNetworking** icon from your Windows desktop. Then follow all onscreen instructions.



.....
Note: Easy Networking is not capable of establishing a network connection for computers running outside Microsoft NT, Novell NetWare, or the Internet.

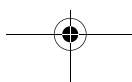
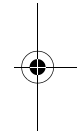
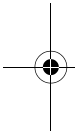



► TimeMachine

TimeMachine is a tool that helps you recover your computer by saving and restoring critical system files back to the time your computer was working properly. During normal operation, this utility runs silently in the background and checks your computer system files daily by automatically taking a snapshot image of the critical system files and saving the snapshot as a file. Only one snapshot is taken per day. However, when an error occurs or when the user attempts to shut down Windows while a snapshot is being created, the snapshot function fails. From the saved snapshots, you can select the snapshot you want to restore your critical system files to.

You may need to run TimeMachine when you encounter a computer problem. To run Time Machine, do either of the following:

- If you are running Windows:
 - a. Select the **TimeMachine** icon from your Windows desktop. The TimeMachine user interface appears on the screen offering the following functions:
 - (1) Restore a snapshot image
 - (2) Undo the last snapshot restored
 - (3) Save additional snapshot images
 - (4) Configure the tool's settings
 - b. Select the desired function and follow the onscreen directions and tips.
 - c. Wait for the results to be displayed.
- If you are running DOS:
 - a. Boot from the Programs CD.
 - b. Select the **TimeMachine** option. Under DOS, TimeMachine offers only one function, i.e., Restore a snapshot image.
 - c. Select the snapshot image file you want to restore your critical system files to.
 - d. Wait for the results to be displayed.

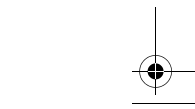
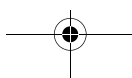
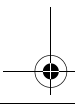
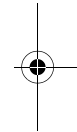
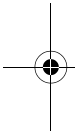



▶ PC-cillin

PC-cillin is an antivirus program designed to scan and clean computer viruses from your computer's hard drive and floppy drive. To ensure the integrity of your computer data, you should scan your hard drive on a regular basis. Fixes for newly-discovered viruses may not be included in the software provided with your computer. You may contact your software vendor or Trend Micro's Web site (www.trendmicro.com) for updates.

To run PC-cillin:

1. Select the **PC-cillin** icon from your Windows desktop.
2. Select the drives, directory, or files you want to scan.
3. Select the scan option to begin the virus check. If PC-cillin finds any infected files, it will list several options for you to follow.

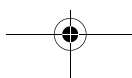
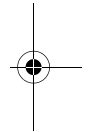
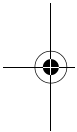



► PC-Doctor

PC-Doctor contains comprehensive hardware diagnostics and system information tests that you can run to verify the functionality of your computer's hardware components. Components can be tested individually or together according to your preferences. If you suspect that you may have a hardware component failure, you will need to run this program prior to contacting your manufacturer for technical support.

You may also use this utility to check and obtain detailed information about your computer. This information will serve as reference and may help diagnose system problems.

To run PC-Doctor, do either of the following:

- If you are running Windows:
 - a. Select the **PC-Doctor** icon from your Windows desktop.
 - b. Follow the directions on the screen.
- If you are running DOS:
 - a. Boot from the Programs CD.
 - b. Select the **PC-Doctor** option.
 - c. Follow the directions on the screen.

For more information about PC-Doctor, you may refer to the following Web site: www.ws.com



▶ ASM Pro Suite

Advanced System Manager (ASM) Pro Suite is a desktop management tool designed to monitor performance, manage assets, and detect errors or potential system malfunctions in network systems. It helps the system administrators to spot errors or potential system malfunctions in the network devices through a single management station. This prevents machine breakdowns and reduces the enterprise's Total Cost of Ownership (TCO).

The basic features of ASM Pro Suite are as follows:

- **Remote Complementary Metal Oxide Semiconductor (CMOS) Update** - allows update of Setup and Time/Date settings of the computers connected in a network through a single management station.
- **Remote Flash Basic Input/Output System (BIOS) Update** - makes the upgrade of the BIOS software instructions of the computers connected in a network easier through a single management station.
- **Remote Console**- enables update, upload, and transfer of programs and files between computers connected in a network. System administrators find this function very useful especially when maintaining, diagnosing, and troubleshooting computers.
- **LANdesk Client Manager (LDCM)** - broadens the functionality of ASM Pro Suite by allowing desktop management via the Web, standard network, or dial-up connections. It is compatible with the leading management specifications, such as Wired for Management 2.0, Desktop Management Interface (DMI) v2.0, and others.
 - **System Information** - helps locate available computers in your network and collects general computer information like operating system, protocols, addresses, etc.
 - **Configuration Information** - shows the configuration of each device (i.e., BIOS, I/O ports, hard disks, network interface cards, etc.) installed in each computer in a network.
 - **Fault Management** - checks the computers for hardware errors and observes whether or not a certain device has exceeded its threshold value. If so, the program notifies the system administrator or shuts down the computer to protect it from further damage.

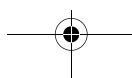
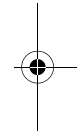
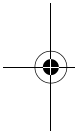



Note: The number of additional utilities offered by ASM Pro Suite varies for every product and model.

ASM Pro Suite may not be preloaded on your computer. In such a case, you will need to install it. To do so, do the following:

1. Make sure that your computer is turned on.
2. Insert the Programs CD that came with your computer into the CD-ROM drive.



Caution! Make sure that the CD is properly inserted into the CD-ROM drive. Improper insertion may damage both the CD and the CD-ROM drive. For instructions, please see "To insert a CD into your computer's CD-ROM drive:" on page 20.

3. Follow all onscreen instructions until you finish the installation.



Note: ASM Pro Suite currently supports Microsoft Windows 98 and NT.

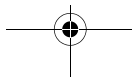

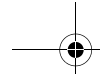

► Reinstalling applications

If you uninstall one of the preinstalled programs and want to reinstall it, do the following:

1. Make sure the system is turned on.
2. Insert the Programs CD into the CD-ROM drive.
3. Select the application that you want to reinstall.
4. Follow all onscreen instructions until you finish the installation.

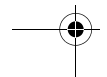
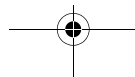
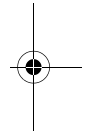
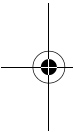

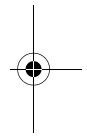
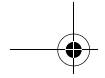

6 Q & A

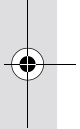
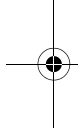
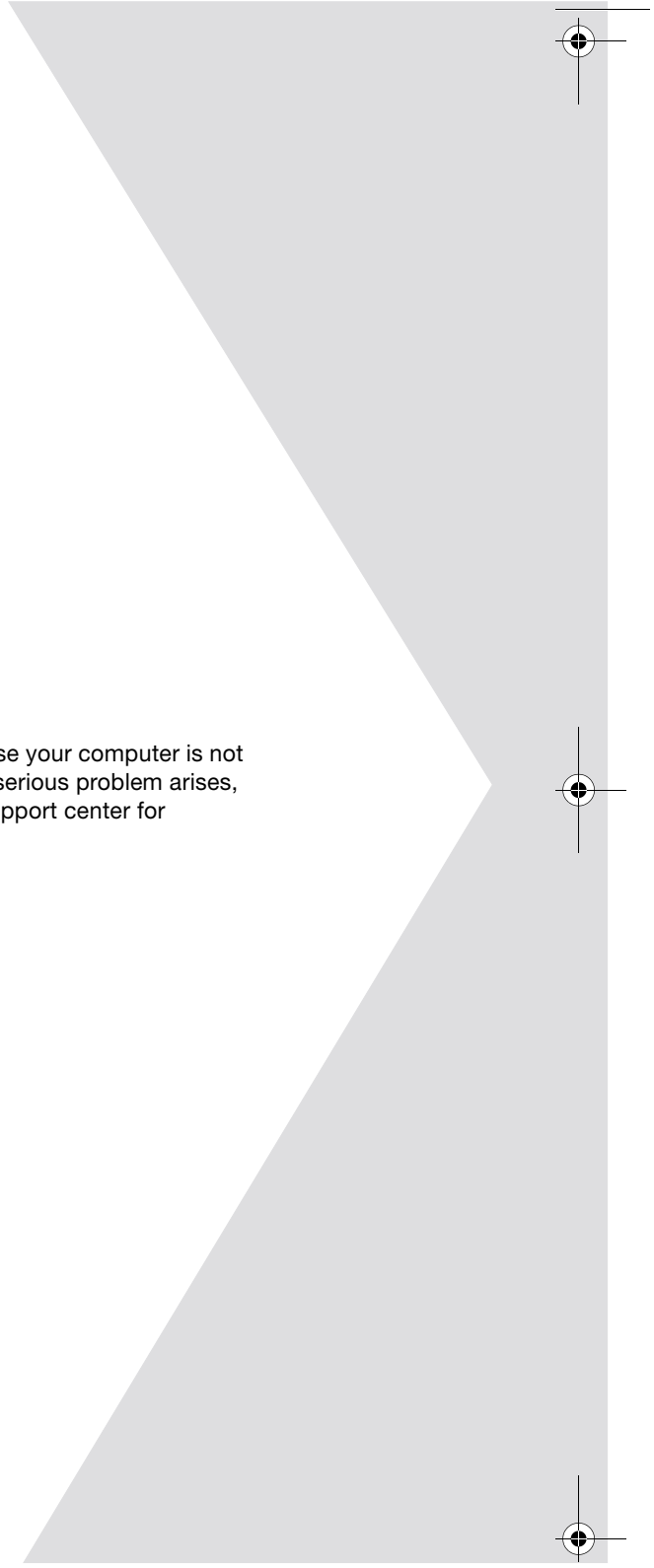
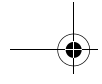

This chapter tells you what to do in case your computer is not working properly. However, if a more serious problem arises, contact your dealer or the technical support center for assistance.

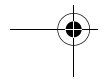
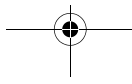



The following questions are possible situations that may arise during the use of your computer and each is followed by easy answers and solutions to the situation.

Q: I pressed on the power button but the system did not boot up.

A: Check the LED located at the center of the power button.

If the LED is not lit, no power is being applied to the system. Do any of the following:

- Check if you plugged the power cable properly into an electrical outlet.
- Check if the main power switch on the right panel of your computer is switched to “ON” (1). See page 30 for the location of the main power switch on your computer.
- If you are using a power strip or AVR, make sure that it is plugged in and turned on.

If the LED is lit, check the following:

- Is a nonbootable (nonsystem) diskette in the floppy drive? If yes, remove or replace it with a system diskette and press **Ctrl + Alt + Del** to restart your computer.
- The operating system files may be damaged or missing. Insert the startup disk you created during Windows setup into the floppy disk drive and press **Ctrl + Alt + Del** to restart your computer. This will automatically diagnose your system and make necessary fixes.

Q: Nothing appears on the screen.

A: Your computer’s power management function automatically blanks the screen to save power. Just press any key to turn the display back on.

If pressing a key does not work, contact your dealer or the technical support center for support.

Q: The serial mouse does not work.

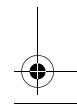
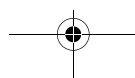
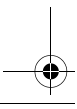
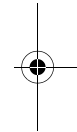
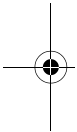



A: Make sure that the serial cable is plugged securely into the serial port. See “Connecting a serial mouse” on page 37 for information on how to connect a serial mouse.

Q: The printer does not work.

A: Do the following:

- Make sure that the printer is connected to a power outlet and that it is turned on.
- Make sure that the printer cable is connected securely to the system’s parallel port and the corresponding port on the printer. See “Connecting a printer” on page 38 for information on how to connect the printer to your computer.
- For additional information concerning the printer, refer to the printer’s documentation.

Q: No sound comes out from the computer.

A: Check the following:

- The volume may be muted. Under Windows, look for the volume control icon on the taskbar. If it is crossed-out, click on the icon and deselect the **Mute** option.
- If headphones, earphones, or external speakers are connected to the line-out port of your computer, the internal or built-in speakers are automatically turned off.

Q: Image is not full screen.

A: Make sure that the resolution is set to 1024 x 768. Right-click on your Windows desktop and select **Properties** to bring up the Display Properties dialog box. Then click on the **Settings** tab to check the resolution setting.

If the setting is incorrect, click and drag the Screen area slider to **1024 x 768**, then click on **OK**.

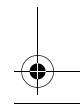
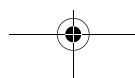
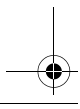
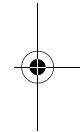
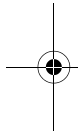

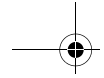

Q: System cannot read diskette, hard disk, and/or CD information.

A: Check the following:

- Make sure that you are using the correct type of disc or diskettes. See "Disk drives" on page 19.
- Check if the diskette is formatted correctly. If not, format it again.
- Make sure the diskette or CD is inserted into the drive correctly.
- Check if the CD is clean and not scratched.
- Check your drive by using a good (i.e., undamaged) diskette or a good CD. If your floppy disk drive or CD-ROM drive can not read the information on the good diskette or CD, there may be a problem with the drive. Contact your dealer or technical support center for help.

Q: System cannot write diskette and/or hard disk information.

A: Check the following:

- Make sure the diskette or hard disk is not write-protected. See "Disk drives" on page 19.
- Make sure that you are using the correct type of disc or diskette. See "Disk drives" on page 19.
- Check if the diskette is formatted correctly. If not, format it again.

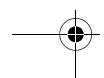
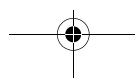
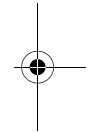
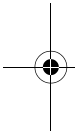

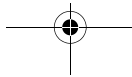
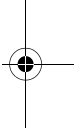
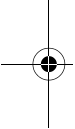
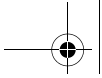

Index

C

- computer maintenance 4
 - cleaning 4
 - servicing 4

D

- disk drives 19
 - CD-ROM drive 19
 - inserting 20
 - taking care CDs 21
 - floppy drive 19
 - not write protect 19
 - write protect 19
 - hard disk drive 21

F

- features 9
 - connectivity 9
 - design 10
 - ergonomics 10
 - multimedia 9
 - performance 9
- front panel 11

K

- keyboard 16
 - cursor keys 16
 - lock keys 16
 - windows-keys 17

M

- mouse 18
 - buttons 18
 - clicking 18
 - double-click 18
 - ratchet wheel 18

P

- ports 12
 - left panel 13
 - right panel 15

Q

- Q&A 57

S

- setting up computer 25, 27
 - area 25
 - chair 25
 - keyboard 25, 28
 - mouse 26, 27
 - PC 26
 - power cable 29

T

- turning off computer 31
 - software shutdown 31
 - suspend mode 31
- turning on computer 30
 - main power switch 30
 - power button 30

U

- upgrade
 - computer 43
 - external monitor 36
 - modem 40
 - multimedia devices 41
 - joystick 41
 - speakers 41
 - network 38, 39
 - printer 38
 - replace components 43
 - serial mouse 37
 - side panel cover 35
 - remove 35
- upgrade multimedia devices
 - microphone 41