

420 D/410 D/  
320 D/310 D

Fume Extractor Hoods

Instructions for Installation and Use

## Gebrauchsanweisung unbedingt lesen und aufbewahren!

**D**

<i>Inhaltsverzeichnis</i>	Seite		Seite
<b>Bildseiten</b> (bitte ausklappen)	4—8	<b>Für den Benutzer</b>	17
<b>Ausstattung</b>	9	<b>Bedienung der Dunstabzugshaube</b>	17
<b>Technische Daten/</b>		<b>Wartung und Pflege</b>	18
<b>Zubehör und Montagematerial</b>	9/10	<b>Reinigung</b>	19
<b>Für die Elektro-Installation</b>	11	<b>Sonderzubehör</b>	19
<b>Vor der Montage</b>	11—13	<b>Störungen</b>	19
<b>Montage</b>	13—16		

## It is essential to read these Instructions for Use and keep them in a safe place!

**GB**

<i>Contents</i>	Page		Page
<b>Illustration pages</b> (please unfold)	4—8	<b>Installation</b>	25—28
<b>Equipment</b>	20	<b>For the user</b>	28
<b>Technical data/Accessories and fittings</b>	20/21	<b>Operation of fume extractor hood</b>	29
<b>Electrical installation</b>	22/23	<b>Maintenance and care/Cleaning</b>	30/31
<b>Prior to installation</b>	23—25	<b>Special accessories/Faults</b>	31

## Lire attentivement et ranger soigneusement ce mode d'emploi

**F**

<i>Contenu</i>	Page		Page
<b>Pages d'illustration</b> (prière de les déplier)	4—8	<b>Remarques pour l'utilisateur</b>	40
<b>Équipement</b>	32	<b>Utilisation de la hotte de cuisine</b>	40
<b>Données techniques</b>	32/33	<b>Entretien et soins</b>	41/42
<b>Accessoires et matériel de montage</b>	33	<b>Nettoyage</b>	42
<b>Remarques pour l'installation électrique</b>	34	<b>Accessoires supplémentaires</b>	42
<b>Avant le montage</b>	34—36	<b>Pannes et remèdes</b>	43
<b>Montage</b>	36—39		

## Leggere immancabilmente e conservare le istruzioni per l'uso!

**I**

<i>Indice</i>	Pagina		Pagina
<b>Pagine illustrate</b> (preghiamovi aprire pagina)	4—8	<b>Per l'utente</b>	53
<b>Corredo</b>	44	<b>Comando della cuffia di aspirazione dei vapori</b>	53
<b>Dati tecnici, accessori e materiale di montaggio</b>	44/45	<b>Manutenzione e cura</b>	54/55
<b>Per l'elettroinstallatore</b>	46	<b>Pulizia</b>	55
<b>Prima del montaggio</b>	46—48	<b>Accessori speciali</b>	55
<b>Montaggio</b>	49—52	<b>Difetti</b>	56

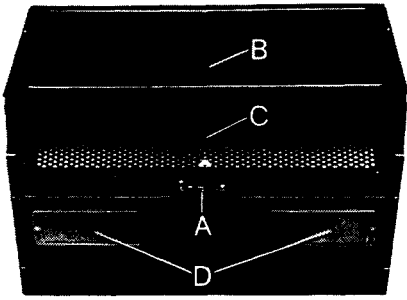

1

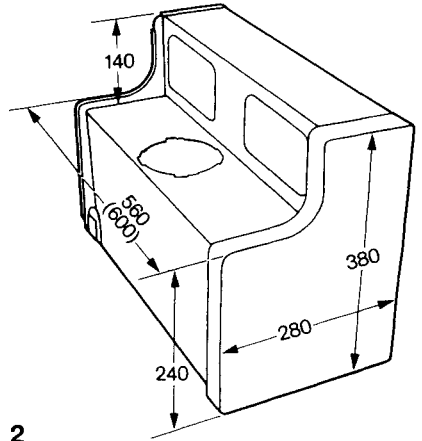

2

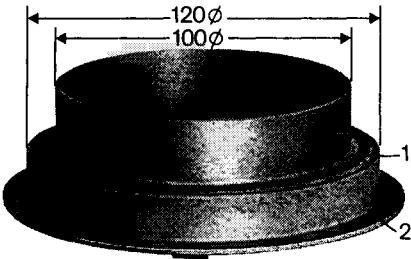

3

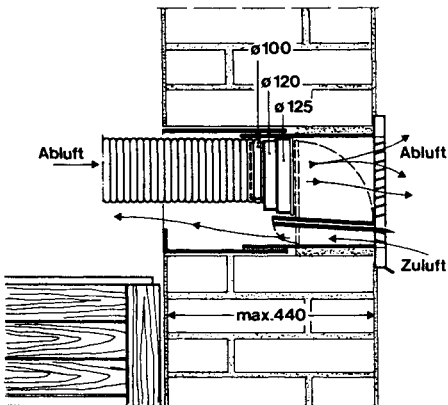

4

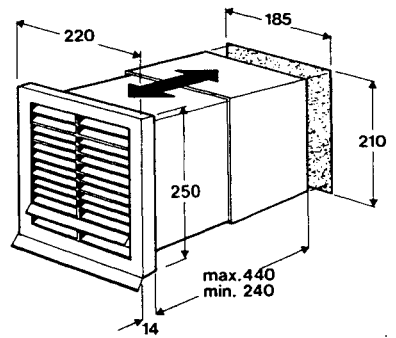

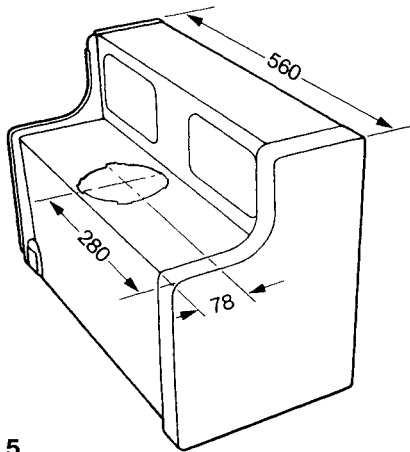

5

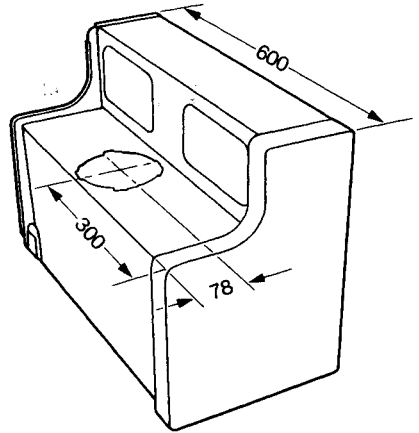

6

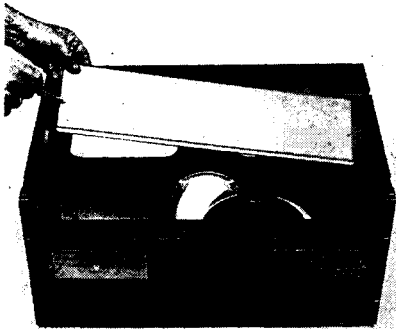

7

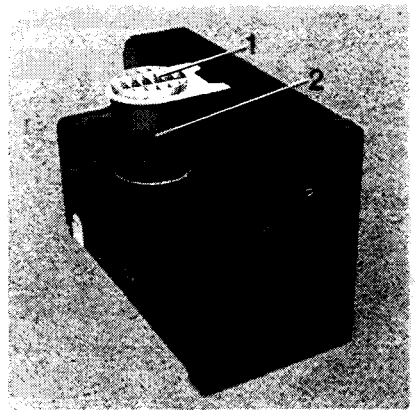

8

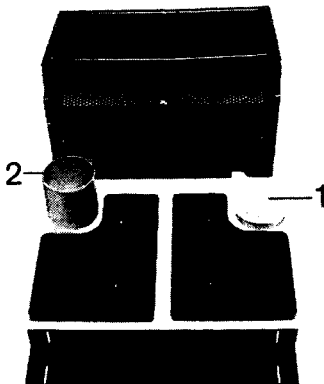

9

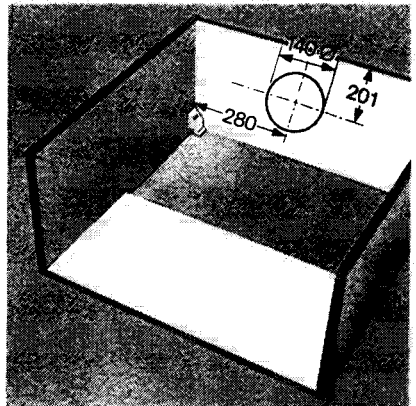

10

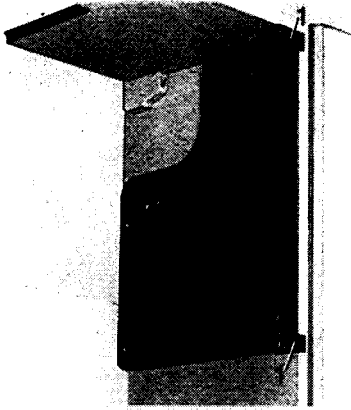

11

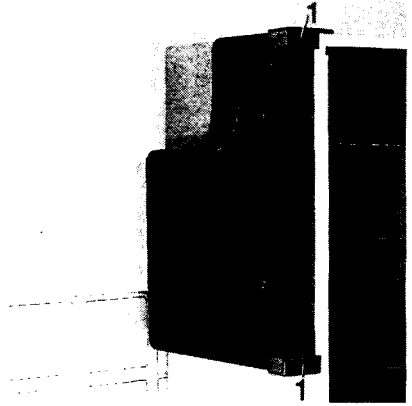

12

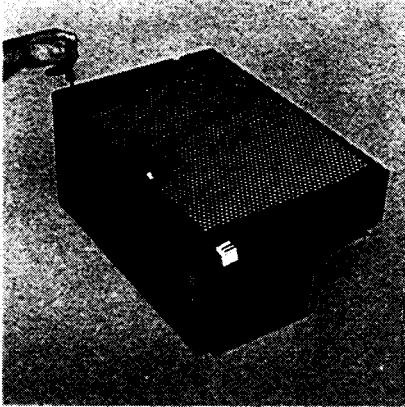

13

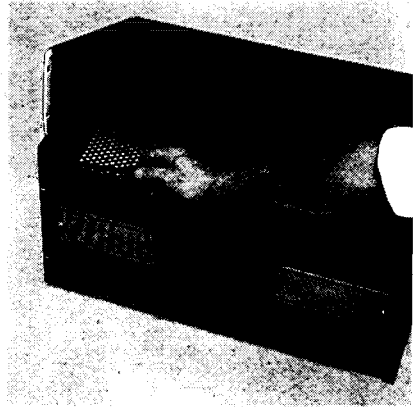

14

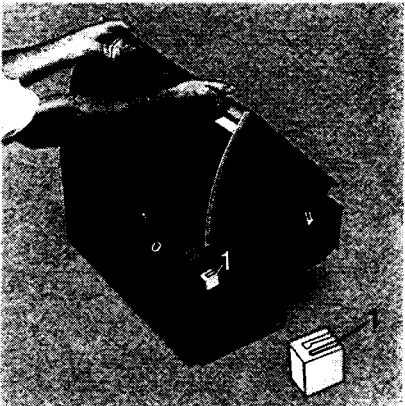

15

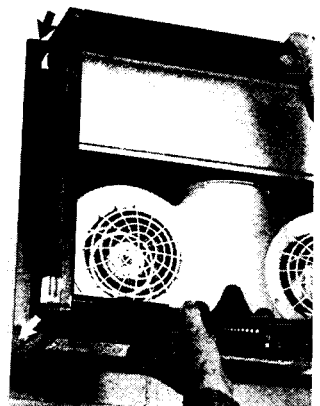

16



17

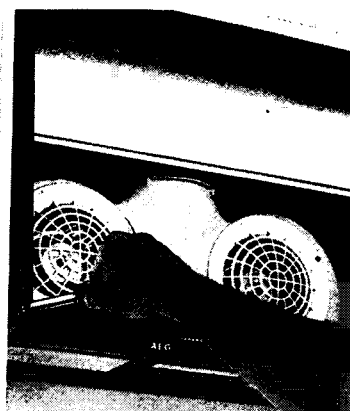

18

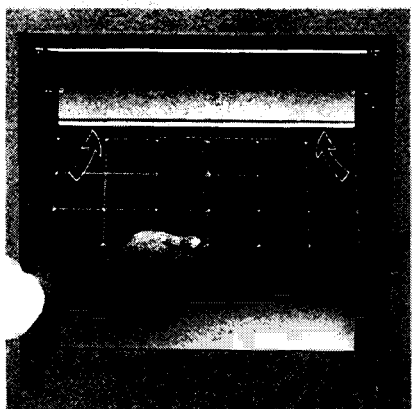

19

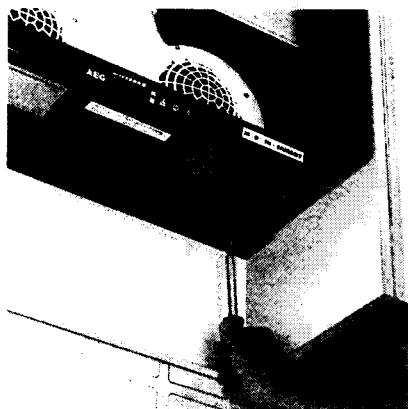

20

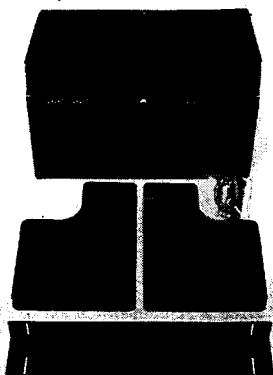

21

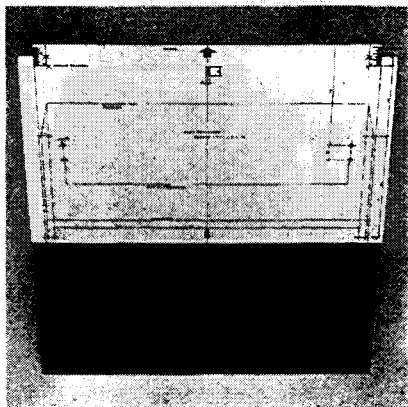

22

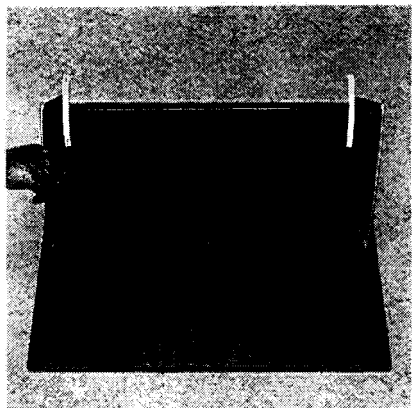

23

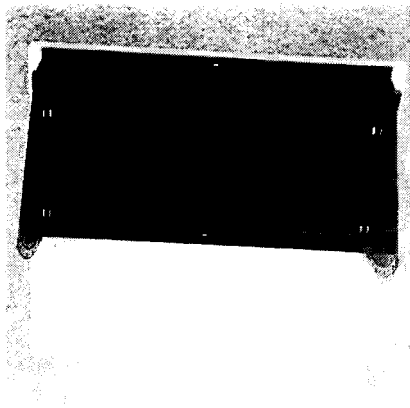

24

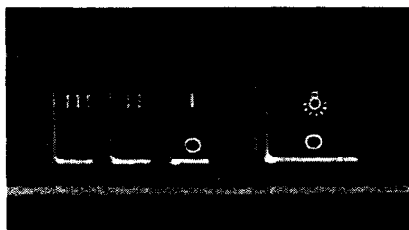

25

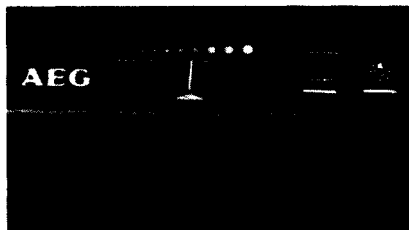

26

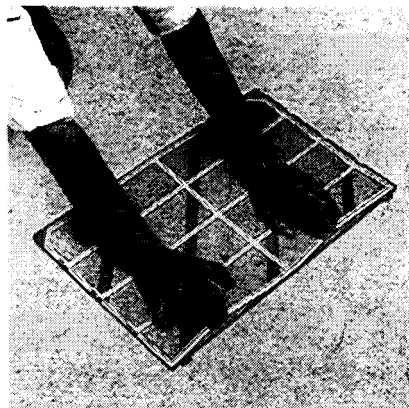

27

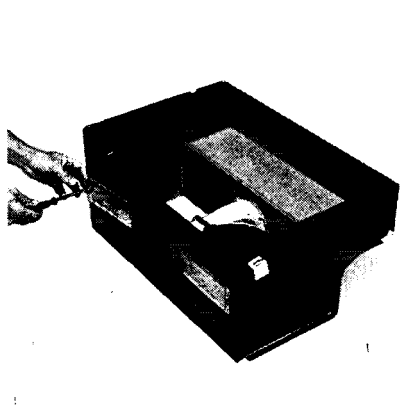

28

## **Operation of fume extractor hood**

**Important! The appliance may only be switched on when fully installed, i.e. with applied pipe section and outlet grille (return air operation) or with connected exhaust air pipe system (exhaust air operation)!**

The required operating mode (motor running and/or lighting) can be preselected on the control panel. The appliance is then switched "On/Off" by opening and closing the fume protection panel.

## **Appliance description (Fig. 1)**

**A** = switches

**B** = fume protection panel

**C** = filter grille

**D** = lighting

## **General**

The fume extractor hood is supplied as an exhaust air appliance and may be used as a return air appliance through application of an active carbon filter (**special accessory**).

## **Air outlet**

Above (**Fig. 2**)

Pipe connection stepped from 100 to 120 mm dia. and provided with preset breaking point (**Fig. 3/1,2**) for exhaust air hoses of 100 and 120 mm dia.

## **Technical data**

### **Dimensions:**

Height / width / depth (mm)

310 D/320 D 380 x 600 x 280

410 D/420 D 380 x 560 x 280

### **Weights:**

Net: 11 kg

## **Connection**

220 V ~ via fixed supply lead with protective contact plug (Europa version).

240 V ~ via fixed supply lead (UK).

(Fixed connection to be made only by approved electrical installer).

## **Connected load**

Total connected load 260 W

Fan motor 140 W

Lighting: 2 x 60 W max.

Sockets for E 14 candle lamps



## Technical data

### Fan outputs to DIN 44971 (m<sup>3</sup>/h)\*

		Setting 1 "Min." setting	Setting 2	Setting 3 "Max." setting
<b>310 D/410 D (3 settings)</b>	<b>exhaust air</b>	135	190	265
	<b>return air</b>	100	160	230
<b>320 D/420 D (continuously variable)</b>	<b>exhaust air</b>	135		265
	<b>return air</b>	100		230

\*Exhaust air with 120 mm dia. pipe system; return air with KAFD Original Carbon Filter

## Accessories and fittings

### 410 D/420 D

- |   |  |
|---|--|
| <ul style="list-style-type: none"> <li>2 Side parts with mounting templates applied<sup>1)</sup></li> <li>6 3.5 x 9.5 poszdrive screws (for joining side parts to housing)</li> <li>6 A 3.2 fan screws for that purpose</li> <li>10 Poszdrive screws (for joining side parts to furniture side wall)</li> <li>1 Pipe connection with outlet grille</li> <li>2 3.5 x 9.5 screws (for joining outlet grille to cabinet ceiling)</li> <li>1 Drilling template (for joining furniture door to fume protection panel)</li> <li>1 Exhaust air connection-piece (100/120 mm dia.)</li> <li>1 Wall end panel</li> <li>2 3.5 x 6.5 panel screws (for joining wall end panel to appliance floor)</li> <li>6 Poszdrive screws (for joining furniture door to fume protection panel)</li> </ul> | <ul style="list-style-type: none"> <li>1 Drilling template (for joining furniture door to fume protection panel and wall mounting)</li> <li>1 Exhaust air connection-piece (100/120 mm dia.)</li> <li>1 Wall end panel</li> <li>2 3.4 x 6.5 panel screws (for joining wall end panel to appliance floor)</li> <li>2 4.5 x 60 wood screws and 2 6 x 60 mm dia. wall plugs</li> <li>6 Poszdrive screws (for joining furniture door to fume protection panel)</li> <li>4 Washers (for joining furniture door to fume protection panel)</li> </ul> |
|---|--|

For wall mounting:

- |  |                                 |
|--|---------------------------------|
| <ul style="list-style-type: none"> <li>1 Wall mounting angle</li> <li>2 6 x 60 mm wall plugs</li> <li>2 4.5 x 60 wood screws</li> <li>1 Mounting rail</li> <li>1 Counterrail</li> <li>4 M 6 x 25 screws</li> <li>4 M 6.4 fan washers</li> <li>1 M 6 nut</li> <li>3 6.4 dia. washers</li> </ul> | } prefitted in supplied package |
|--|---------------------------------|

### 310 D/320 D

- 2 Side parts with mounting templates applied<sup>1)</sup>
- 6 3.5 x 9.5 poszdrive screws (for joining side parts to housing)
- 6 A 3.2 fan screws for that purpose
- 10 Poszdrive screws (for joining side parts to furniture side wall)
- 1 Pipe connection with outlet grille
- 2 3.5 x 9.5 screws (for joining outlet grille to cabinet ceiling)

<sup>1)</sup> Are removed after side wall fitting!

---

## Electrical installation

---

### **Electrical connection (appliances with connected load below 3000 watts)**

**Warning! All appliances with a 3 core lead must be earthed.**

#### **Voltage and current**

Please ensure that the voltage and current indicated on the rating plate agree with the voltage of your electricity supply.  
220/240 volts — (i.e. 220/240 V a.c.)

#### **Electrical connection**

Please note! (For users in the U.K.).  
If your appliance has been equipped with a mains lead with a moulded-on type plug, you must comply with the following regulations:  
The plug moulded on to the lead incorporates a fuse. For replacement, use a 13 amp BS 1362 fuse. Only ASTA approved or certified fuses should be used. If the fuse cover/carrier is lost, a replacement cover/carrier must be obtained from electrical goods retailers. If the socket outlets in your home are not suitable for the plug fitted to the appliance, then the plug must be cut off and destroyed for safety reasons, and an appropriate plug fitted. When fitting the plug please note the following points:

#### **Important**

The wires in the mains lead are coloured in accordance with the following code:

Green and yellow	Earth
Blue	Neutral
Brown	Live

Some appliances have a twin core mains lead, when no earth is required.

As the colours of wires in the mains lead of this appliance may not correspond with the coloured markings identifying the terminals in your plug proceed as follows:

1. The wire which is coloured green and yellow must be connected to the Earth terminal in your plug, which is marked with the letter E or by the earth symbol  or coloured green, or green and yellow.
2. The wire which is coloured brown must be connected to the Live terminal which is marked with the letter L or coloured red.
3. The wire which is coloured blue must be connected to the Neutral terminal which is marked with the letter N or coloured black.

When wiring the plug, ensure that all strands of wire are securely retained in each terminal. Do not forget to tighten the mains lead clamp on the plug. This appliance meets the radio interference suppression requirements of EC Directive 82/499 EC and the standards concerning the effects of electrical appliances on power systems EN 60555 Parts 1—3/DIN VDE 0838 Parts 1—3, June 1987.

Voltage	220/240 V AC
Fuse rating	13 amps

See rating plate for further information.

---

## Electrical installation

---

Arrangement of the protective contact plug socket directly above the fume extractor hood or above the overhead cabinet confers two advantages:

1. **The plug socket is not visible.**
2. **You can easily de-energize the appliance where necessary by unplugging it.**

For the necessary fixed connection, the fume extractor hood should be connected only by an electrical installer registered with the competent electricity supply company. An isolating device is to be provided on the fixed wiring side. **Switches with a contact opening of more than 3 mm apply as isolating device.** These include LS switches, fuses, and contactors (VDE 0730, s. 7, Part 1).

---

## Prior to installation

---

### *Important:*

The exhaust air may not be introduced into a smoke flue or exhaust gas chimney. Introduction of the exhaust air into a shaft used for ventilation of the installation spaces of firerooms is not permitted.

If the exhaust air is introduced into a non-operational smoke flue or exhaust gas chimney, it is advisable to seek the consent of the competent chimney-sweep. The official exhaust air guidance regulations are basically to be complied with.

During operation as an exhaust air appliance, an adequate supply air opening of approximately the same size as the exhaust air opening is to be ensured. According to the Provincial Building Regulations, the joint operation of fume extractor hoods and chimney-linked fireplaces, such as coal- or oil-fired ovens and gas heaters, in the same space is subject to specific restrictions. In such spaces, the Fireplace Regulations only allow an underpressure of max. 0.04 mbar.

The safe joint operation of chimney-linked appliances and fume extractor hoods is only guaranteed if space and/or dwelling (space/air interaction) are externally ventilated by a suitable supply air opening of around 500–600 cm<sup>2</sup> and an underpressure thereby avoided when the fume extractor hood is running. In doubtful cases, please seek the advice and consent of the competent area chimney-sweep or the local building authorities.

Since, in spaces without fireplace, the rule is: "Supply air opening as large as exhaust air opening", the efficiency of the exhaust air device may be impaired by the greater opening of 500–600 cm<sup>2</sup>. Operation of the hood as a return air hood in such circumstances is safe and is not subject to the regulations noted above.

If the fume extractor hood is installed above electric, gas, oil, or coal ovens, a minimum distance from the oven plate to the bottom edge of the fume extractor hood of 650 mm is to be ensured.

---

## Prior to installation

---

### **Preparation as exhaust air appliance**

If the kitchen fume is run out into the open air through the external wall, you need a **telescopic wall box (special accessory, Fig. 4)**. Order via AEG after-sales service or dealership; wall box with supply and exhaust air duct.

**For dimensions and position of air outlet openings:**

(Fig. 5) 410 D/420 D

(Fig. 6) 310 D/320 D

**For exhaust air connection of the fume extractor hood to the wall box, it is best to use non-flammable exhaust air hose E-No. 610 899 007 (120 mm dia.) from our range of special accessories.**

We further recommend flame-retardant materials, such as for example KA piping.

**The exhaust air opening has a theoretical opening of 100 or 120 mm dia.**

This can be used to fit exhaust air hoses of 100 or 120 mm dia.

For 100 mm dia., fit directly with hose clamp. For 120 mm dia., cut the exhaust air connection-piece (**Fig. 3**) at the **preset breaking point (Fig. 3/1,2)**. The exhaust air connection-piece is to be fitted by clockwise rotation on the bayonet catch of the air outlet opening.

**Optimum operation of the fume extractor hood in exhaust air mode is assured only if the following points are noted:**

- short, straight exhaust air runs
- as few as possible pipe bends
- running of pipes, not at sharp angles, but in smooth flat arcs
- as large as possible pipe diameter (on hoods powered by two motors, basically min. 120 mm)

**Failure to observe these principles will result in serious power losses and increased operating noise.**

---

### **Preparation as return air appliance**

For return air operation, you need the Original AEG KAFD Active Carbon Filter (**see special accessories on page 31**).

On the supplied exhaust air connection-piece (120/100 mm dia.), the 100 mm

connection collar is to be circularly separated at the preset breaking point with a knife. The exhaust air connection-piece is to be fitted by clockwise rotation on the bayonet catch of the air outlet opening.

---

### **Installation options**

**Installation in furniture surround (410 D/420 D)**

**Installation between two cabinets (310 D/320 D)**

**Installation by wall mounting at end of wall cabinet run (310 D/320 D)**

---

## Prior to installation

---

### *Preparation of furniture surround for exhaust air operation*

The design of 410 D/420 D appliances enables the exhaust air hose to be run backwards or to the side. After removal of the cover panel (**Fig. 7**) inside the appliance rear wall, this area becomes accessible from the front, even with the hood in place, for coupling of the exhaust air hose with the exhaust air connection-piece on the appliance! According to the envisaged exhaust air run, openings of

adequate size are to be provided in the surround for the selected exhaust air system (100 mm dia./120 mm dia. pipe – hose – flat duct) in ceiling, rear wall, or side wall. The exhaust air connection-piece is centrally positioned about the appliance width. For further dimensions, see **Fig. 5**. **It is to be ensured that, when fitted, the appliance always has a 5 mm rebound relative to the furniture body edge.**

---

### *Preparation of furniture surround for return air operation*

To run through the pipe connection (120 mm dia.), a cutout is to be provided in the cabinet ceiling (**Fig. 10**). Via this cutout, when the appliance is fitted, the outlet grille (**Fig. 9/1**) is screwed together so that the pipe connection (**Fig. 9/2**) is also thereby

fixed in its installation position. On its top side, the outlet grille has a 116 mm dia. pipe collar so that, with the aid of commercially available ducting, a return air outlet via the furniture front panel can also be provided by the builder.

---

## Installation

---

### *Installation in furniture surround (410 D/420 D)*

The appliance can be easily fitted in the already mounted furniture surround by a fitter. See also fittings on page 21 (**Fig. 9**).

1. Apply side part (as shown in **Fig. 11**) on RH side flush with front edge of furniture body and bring up against cabinet ceiling to its fullest extent. Any furniture connection screws in region of side walls are to be removed. **The mounting templates (Fig. 11/1) guarantee the distance upwards and from the furniture body backwards.**
  2. **Mount side part on furniture wall with 5 poszidrive screws.** Appliance side wall now rebounds 5 mm to furniture body.
  3. Fit side part on LH side as described under 1. und 2.
  4. Remove mounting templates (**Fig. 11/1**) forwards!
  5. Unbolt grease filter grille below on LH and RH sides and remove forwards below (**Fig. 13**).
  6. Remove fume protection panel from appliance. For this purpose, unscrew setscrews on guide pieces (on LH and RH sides) (**Fig. 14**) until fume protection panel is freely detachable (**Fig. 15**).
  7. Remove internal cover panel (**Fig. 7**).
  8. Uniformly insert fume extractor hood into prepared surround via screwed-in side parts (**Fig. 16**). Align and screw together (three 2.9 x 9.5 panel screws and three A 3.2 fan screws to be inserted) (**Fig. 18**).
-

---

## Installation

---

9. **The fume extractor hood is now to be completed depending on operating mode:**

**Exhaust air operation:**

Couple exhaust air system with exhaust air connection-piece on appliance side. Refit cover panel.

**Return air operation:**

Fit pipe connection through furniture ceiling on exhaust air connection-piece on appliance side. Place outlet grille on pipe connection and screw together with furniture ceiling (3.5 x 9.5) (Fig. 8).

On appliances 410 D/420 D, outlet grille is screwed directly on to housing ceiling.

Further connect any individual return air duct. Insert Original AEG Carbon Filter (as shown in Fig. 19).

10. Loosely fit wall end panel and **measure Y** (page 27) as shown in **Fig. 20**, slide up against wall, and screw tight (**2 screws 3.5 x 6.5**).
11. **Fit furniture front panel on fume protection panel (see page 28).**
12. Insert fume protection panel with screwed-on furniture front panel into appliance, ensuring that side parts of fume protection panel are properly inserted in brake guide on RH and LH sides (Fig. 15/1).  
Screw in the combined retention and brake adjustment screw on the LH and RH sides to its fullest extent and then uniformly loosen until the complete furniture front panel stays open but retains an easy opening and closing action (Fig. 14).  
**After adjustment, check the furniture front retention by withdrawing to the fullest extent!**
13. **Insert grease filter grille**  
Arrange grease filter grille above so that both lugs of grease filter grille engage holding slots below top edge of appliance. Fix locks on RH and LH sides (Fig. 13).
- 

### **Installation between two cabinets (310 D/320 D)**

The appliance can be easily fitted in between two already mounted wall cabinets by a fitter. See also fittings on **page 21 and Fig. 21**.

1. Apply side part at right (according to **Fig. 12**) flush with neighbouring cabinet and/or cabinet ceiling. **The mounting templates (Fig. 12/1) guarantee the distance upwards and from the furniture body backwards.**
  2. Mount side part on furniture wall with screws (poszidrive).
  3. Remove mounting templates (Fig. 12/1) forwards!
  4. The fume extractor hood (ready to fit) is **uniformly** inserted over the side parts (Fig. 17).
  5. For further fitting sequence, see "Installation in furniture surround" on page 25.
- 

### **Installation by wall mounting at end of wall cabinet run (310 D/320 D)**

1. Mark out top edge of cabinet (extension of top edge of neighbouring cabinet).
  2. Apply drilling template — arrow, top edge of cabinet — and mark out and drill (6 mm dia.) two mounting holes each for wall mounting angle and wall end panel.
  3. Apply wall mounting angle (see **illustration on page 27/1**) to wall plug at slot centre and screw together.
- Wall mounting angle is always to be fitted on opposite side of wall cabinet.
-

# Installation

4. Unscrew supplied complete mounting rail (see illustration on page 27/2 and 3) and screw together with appliance ceiling according to position relative to wall mounting angle (see illustration on page 27/1).
5. Fit wall end panel as illustrated on page 27/Table Y so that it remains adjustable for necessary height adjustment of appliance.
6. For fitting of side parts on fixed or separate furniture side wall, see page 26 (installation between two cabinets).
7. Slide appliance into fitted side wall and mount on RH or LH side in prefitted wall mounting angle and screw together by means of horizontal adjusting screw (see illustration on page 27).
8. Mount appliance on available side part (fitted on wall cabinet); three 2.9 x 9.5 screws with fan washers.
9. Mount prefitted separate furniture side wall on appliance; three 2.9 x 9.5 screws with fan washers.
10. Appliance is aligned in height and depth according to firmly fitted side wall by means of adjusting screws (horizontally and vertically) (see illustration on page 27). Tighten M 6 check nut on horizontal adjusting screw (see illustration on page 27).

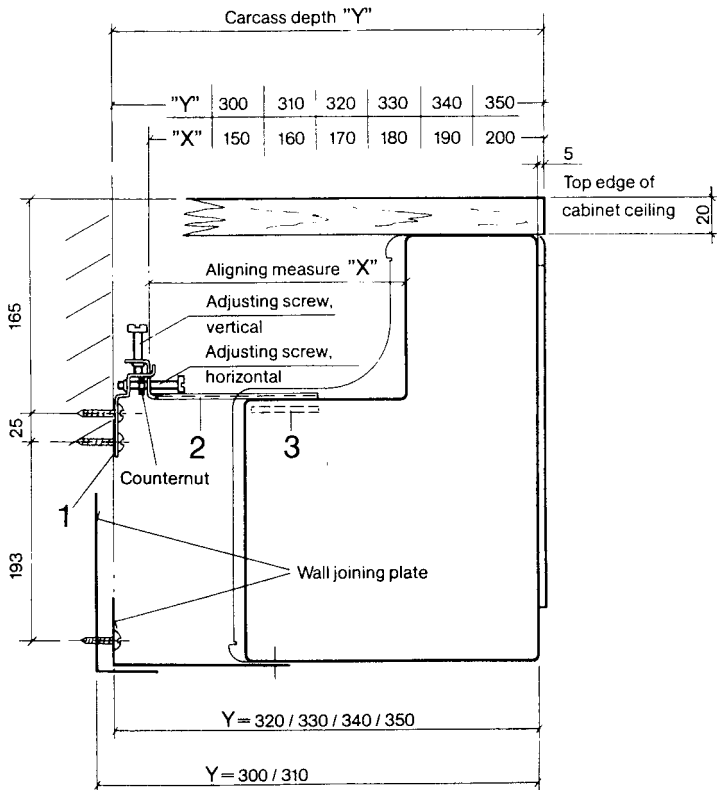

---

## Installation

---

### *Fitting the furniture front panel on the fume protection panel*

#### Installation of 410 D/420 D in furniture surround

1. Determine dimension between cabinet ceiling (bottom edge) and door top edge (neighbouring cabinet) and mark in supplied template (dimension "X"). This dimension then corresponds to top edge of the furniture door. Place template centrally on rear of furniture front panel (**Fig. 22**) and mark out mounting holes.  
**N.B.:**  
**Predrill mounting holes!**
2. Outer slots are to be used for cassette furniture fronts (see template).
3. Place fume protection panel (**Fig. 23**) on furniture front panel and centrally mount in slots with four supplied poszdrive screws.
4. Insert completed furniture front panel with fume protection panel in build-in hood. **After adjustment, check the furniture front by withdrawing to the fullest extent!**
5. Possibly adjust furniture front panel in slots and tighten screws. Remove door and centrally screw in two safety screws (poszdrive) above and below.

---

### *Fitting the furniture front panel on the fume protection panel*

#### Installation of 310 D/320 D between wall cabinets or at end of furniture run

1. Centrally apply fume protection panel (**Fig. 24**) to furniture front.
2. Align fume protection panel **flush with top edge of furniture front panel**.
3. Further fitting of fume protection panel as described under installation of 410 D/420 D.

---

## For the user

---

### **Important:**

It must be ensured **that open flame hobs are always covered so that the filter mats are not damaged** by excessive heat liberation. **During deep-frying over an oven, the appliance used for deep-frying must also be continuously supervised during operation.** The oil contained in the deep-frying appliance may spontaneously ignite through overheating. If contaminated oil is used, spontaneous ignition may occur even more readily. It should be noted that overheating may cause a fire.

**Flambé-cooking under the fume extractor hood is not allowed.**



---

## Operation of fume extractor hood

---

### Function description

The individual numbers and symbols have the following meanings (from right to left):

Fig. 25

#### 310 D/410 D







-  I O = Lighting "On/Off"
- O = Motor switched off
- 1 = Setting 1
- 2 = Setting 2
- 3 = Setting 3

Fig. 26

#### 320 D/420 D

-   = Button pressed, lighting switched off
-  = Button retracted, lighting switched on
- O I  = Button pressed, appliance switched off
-  = Button retracted, appliance switched on
- = Continuously variable blower output
  - = Low output
  - = High output
- End position

---

The furniture door (fume protection panel) can be used to switch the lighting and blower on and off when the build-in fume extractor hood is switched on.

When the furniture door is opened (without the fume extractor hood being previously switched off via the switches), the lighting and set fan output are automatically re-engaged.

The switch settings (310 D/410 D) can only be switched on individually and not jointly or simultaneously. Changeover from one setting to another is possible at all times. The build-in fume extractor hood is to be switched on before cooking begins and allowed to run on around 15 minutes after cooking is completed.

---

## Maintenance and care

---

### *Inserting/changing the grease filter (fleece)*

The grease filter with internal red stripes incorporated in the appliance is replaced by a new filter paper when the red stripes and/or the mark "Please change" with E-No. and F-No. visibly come through. The filter should be changed every 2–3 months depending on use.

When repurchasing (special accessory), please note the special instructions for installation of the filter fleece and washable metal grease filter in the retrofitting kit.

1. Open furniture door to its fullest extent.
2. Open filter grille (**Fig. 13**) and fold out.
3. Inwardly compress holding frame above and below (**Fig. 27**). Remove frame and (old saturated) filter.
4. Clean filter grille (with lukewarm soap-suds) and dry. Insert new filter and re-insert frame.
5. Arrange grease filter grille above so that both lugs of grease filter grille engage holding slots below top edge of appliance. Fix locks on RH and LH sides (**Fig. 13**).

---

### *Inserting/changing the active carbon filter in return air mode*

The active carbon filter must be changed not later than after 12 months. The active carbon filter cannot be washed or regenerated.

Good deodorization is conditional upon a functional active carbon volume matched to the air ducting of your fume extractor hood. This high-grade filter carbon will

then retain an effective deodorizing effect for around 1 year under conditions of average household use. Use therefore only AEG Original Active Carbon Filters and also make sure you change them promptly (see page 31 under Special accessories).

---

### *Inserting/changing the active carbon filter*

1. Open furniture door to its fullest extent.
2. Open filter grille (**Fig. 13**) and fold out.
3. Insert active carbon filter under cover with long web upwards and press in below (**Fig. 19**).
4. Arrange grease filter grille above so that both lugs of grease filter grille engage holding slots below top edge of appliance. Fix locks on RH and LH sides (**Fig. 13**).

The build-in fume extractor hood is then ready to operate in return air mode.

---

### *Light bulb change*

**Important:**

Use 60 W candle lamps,

E 14 socket!

You can change the light bulbs yourself!

Before changing light bulbs, place light switch (**Figs. 25 and 26**) on "O".

1. Unscrew screws of lamp cover (**Fig. 28**) and remove lamp cover.
2. Unscrew defective candle lamp and replace with new one.

---

## Cleaning

---

**Important! To clean the fume extractor hood, de-energize the appliance (e.g. pull out mains plug).**

**At least once per year, you should clean internal surfaces of your appliance free of grease deposits to ensure that its full reliability is retained. Old grease residues are highly flammable. Supersaturated grease and deodorization filters are therefore also to be avoided.**

Clean the external parts with a mild washing-up liquid solution. Never use abrasive detergents, brushes, or scouring powders. Sprays should not be used as cleaners on the internal surfaces of your appliance.

**Important! To clean the fume extractor hood, de-energize the appliance (e.g. pull out mains plug).**

**Never introduce pointed objects into the protective grille of the motor!**

---

## Special accessories

---

KAFD active carbon filter	E-No. 610 899 448	Exhaust air hose	E-No. 610899005
Grease filter (fleece)	E-No. 610 899 114	100 mm dia., aluminium	
(pack of 6 trimmed filters)		Exhaust air hose	E-No. 610899007
MFE metal grease filter	E-No. 610 899 419	120 mm dia., aluminium	
washable (dishwasher)			
and reusable			
Wall box MKZ	E-No. 610 899 004		
(overall dimensions			
H x B 250 mm x 220 mm)			

---

## Faults

---

In case of any enquiries and faults, please call our after-sales service (see service centre list).

When calling, please state the following:

1. The model designation
2. The E-No.
3. The F-No.

**You will find these data on the rating plate after opening the grease filter grille on the RH inside of the fume extractor hood.**

The manufacturer reserves the right to make alterations in design and colour in the interests of technical development without prior notice.

This appliance meets the radio interference suppression requirements of EC Directive 82/499 EC and the standards concerning the effects of electrical appliances on power systems EN 60555 Parts 1—3/DIN VDE 0838 Parts 1—3, June 1987.

---

AEG Hausgeräte AG  
Postfach 1036  
D-90327 Nürnberg 1

© Copyright by AEG

H 260 219 100 - 019210./01 -

**AEG Domestic Appliances Ltd**

Customer Care Department  
55-77 High Street  
Slough  
Berkshire SL1 1DZ

Telephone: 08705 350350