

FAVORIT 375 i/375 U

Dishwasher

Operating instructions

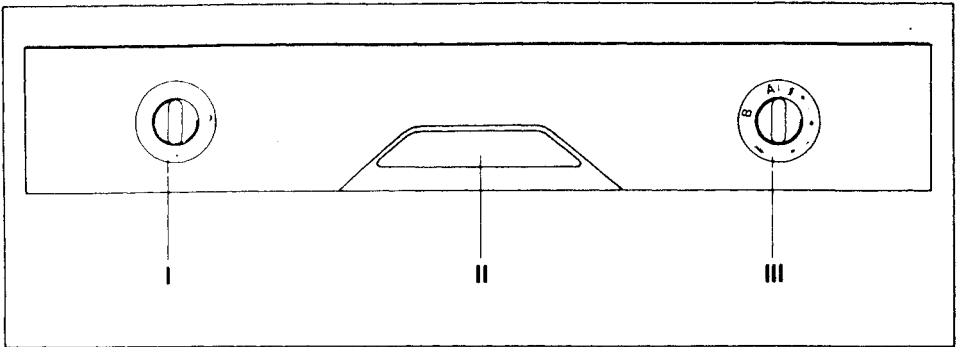

1

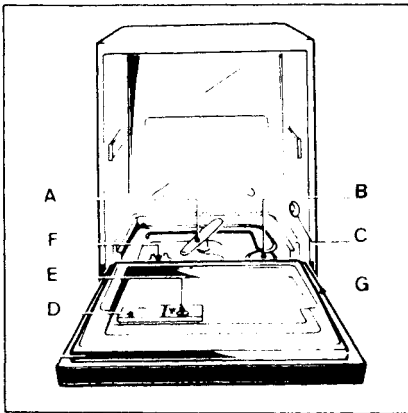

2

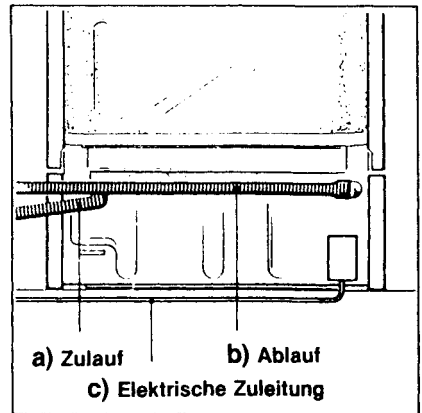

3

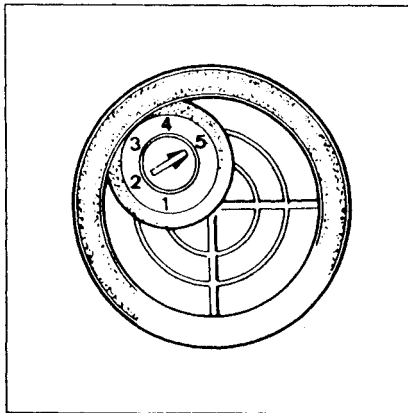

4

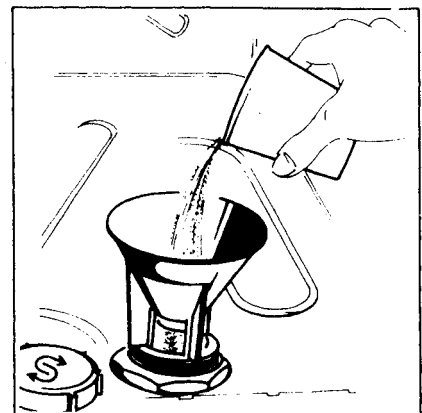

5

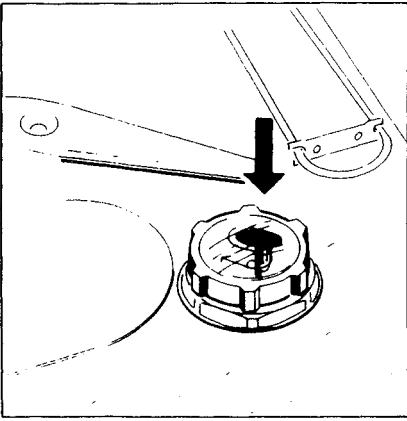

6

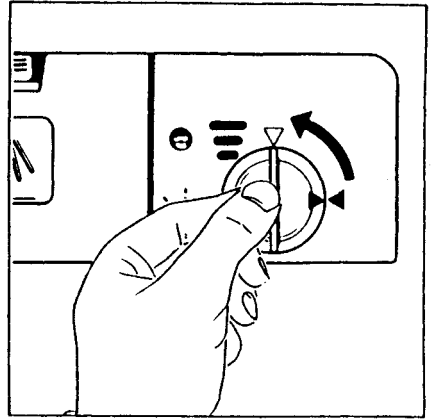

7

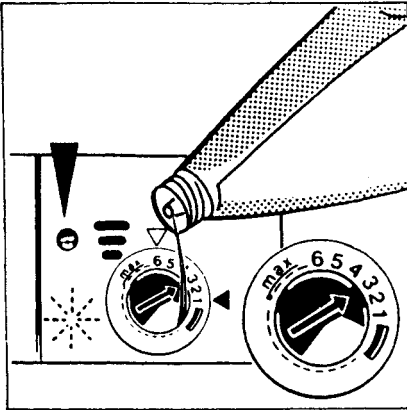

8

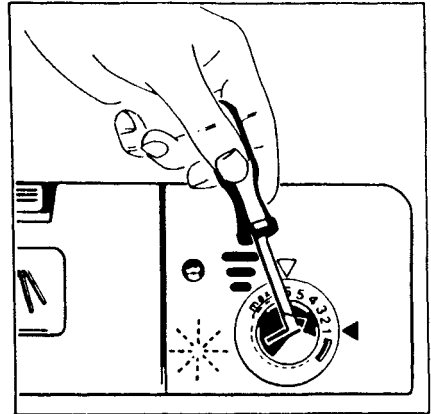

9

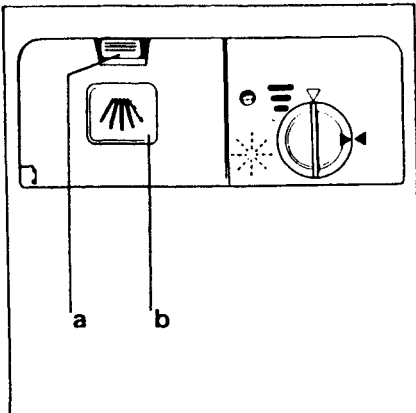

10

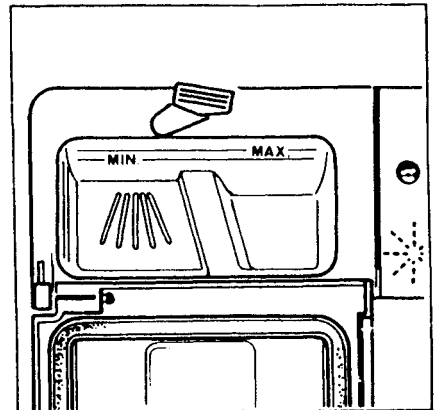

11

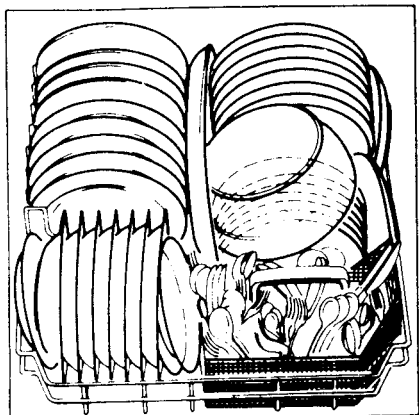

12

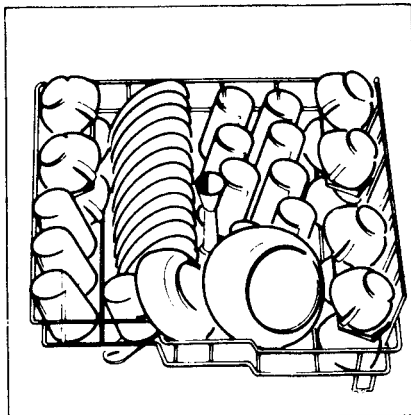

13

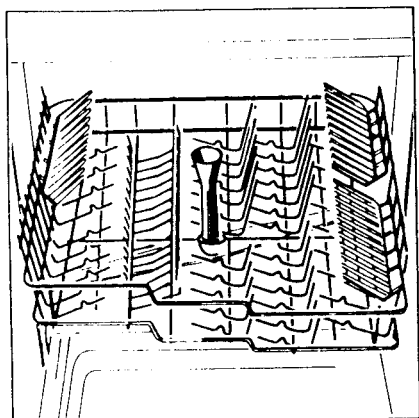

14

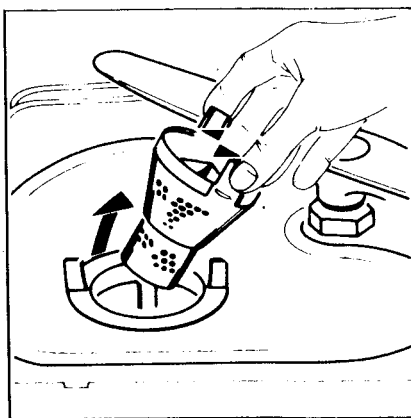

15

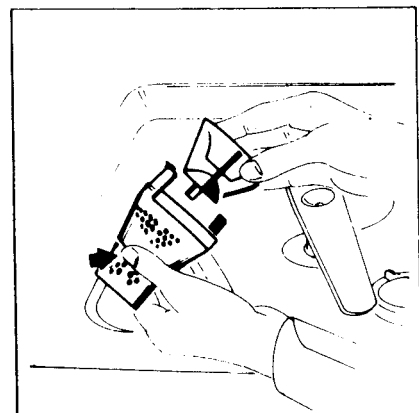

16

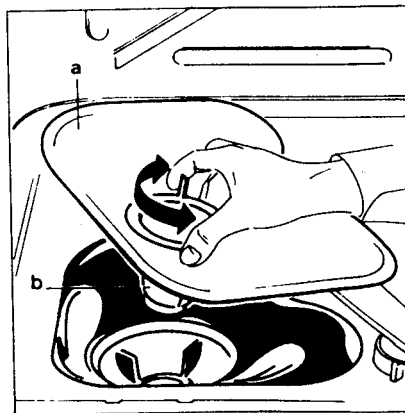

17

Please read the instructions for use and keep them in a safe place!



Your dishwasher should only be installed by a qualified tradesman. Our special installation instructions are given on pages 41—43.

These Operating Instructions will help you take full advantage of all the features offered by this machine. In return for this minor effort, your FAVORIT will reward you with faultless service. You will also save yourself unnecessary maintenance service costs!

Contents

Illustration pages (please unfold)	3— 5	Washing programmes (programme chart)	36—37
Machine description	27—29	Cleaning and care	38
Important hints to help you use your dishwasher correctly	29	If you think your dishwasher is not working properly	38—39
Safety instructions	30	Customer service	40
How to operate your machine:		Notes on installation (Installation — water and electrical connection — water protection system)	41—43
● Setting the water hardness range — Filling with dishwasher salt	31—32	Technical data	44
● Filling with rinse aid — Setting the rinse aid quantity to be dosed	32—33	Arrangement examples	44
● Add dishwashing detergent — before each washing programme	33		
Loading the dishwasher correctly	34		
Starting and stopping — taking out the dishes	35		

Machine description

Please unfold illustration pages 3, 4, 5 before reading on !

Control panel

Fig. 1

- I Programme selector
- II Door release handle (with flap)
- III Programme switch and programme cycle indicator

Inside view

without crockery baskets

Fig. 2

- A Lower spray arm
- B Salt container
- C Hardness range switch
- D Detergent dispenser
- E Rinse aid dispenser
- F Strainers
- G Rating plate (with E- and F-number)

Rear view

Fig. 3

- a) Supply hose
- b) Drain hose
- c) Electrical supply lead

Programme selector (Fig. 1/I)



Switched off



Extra pre-wash



65° C normal programme

Machine description

 65° 65° C economy programme

Programme cycle indicator (Fig. 1/III)



Pre-wash



Washing with detergent



Intermediate rinse



Final rinse with rinse aid



Drying with hot air

Machine description

Crockery baskets

To ensure protection of the crockery baskets during transport, we have packed them with polystyrene foam parts. Please remove all polystyrene foam parts before operating your dishwasher.

Important hints to help you use your dishwasher correctly

- **Operate your dishwasher economically and with regard for the environment:**
Collect your dirty dishes, stack them in the dishwasher, and only wash them when both baskets are full. **Always select the programme corresponding to the degree of soiling of your crockery (according to the chart on pages 36/37).**
- Some types of decoration which have been painted over the glaze may fade after frequent machine washing. Please ensure that earthenware dishes are marked "dishwasher-safe"!
- Parts of aluminium utensils or saucepans also tend to discolour during washing. Some types of glass further become cloudy after many washing cycles.
- Silver crockery and cutlery should always be cleaned free of food residues if they are not washed immediately after a meal (since many food residues, such as egg white, egg yolk, or mustard cause discolorations or staining).
- **The following are unsuitable for machine washing:**
Wooden boards, plastic parts sensitive to hot water, tin crockery, glued crockery parts, and crockery parts with hairline cracks. Also older types of cutlery with temperature-sensitive adhesive as well as rust-sensitive steel knives, and cutlery with wooden, horn, porcelain, and mother-of-pearl handles.
- When you buy new crockery, ensure that its shape is suitable for loading in dishwashers: items should have straight and even surfaces, large openings, flat shallow bases, dishwasher-safe decoration. Glasses and cutlery should also be dishwasher-safe.

Safety instructions

- Only use your dishwasher for machine-washing of household crockery. If the appliance is wrongly operated or used for any purpose other than that for which it is intended, the manufacturer cannot assume liability for any possible damage.
- Do not arrange plastic parts over the heating. Weigh down lightweight plastic parts with other crockery so that they are not lifted and brought into contact with the heating.
- Do not touch the heating immediately after a dishwashing cycle.
- Use only detergents recommended for use in domestic dishwashers.
- Keep detergents out of the reach of children. If swallowed, they may cause mouth and throat irritation or lead to suffocation. Also keep children away from your dishwasher when it is open, since there may still be detergent residues inside.
- Never place solvents in your dishwasher — danger of explosion!
- The water in your dishwasher is not suitable for drinking.
- Children may not recognize the dangers of improper use of electrical appliances. Please therefore ensure proper supervision during operation.
- Children should not play in your dishwasher.
- Do not rest or sit on the open door, since the machine could tilt.
- The inlet hose with a plastic housing on the water connection contains an electric lead for the valve. Do not cut the hose. Do not immerse this housing in water.
- In the event of a fault, close the water tap and switch off (unplug) the machine.
- When the day finally comes to withdraw this appliance from service, please make sure that you inactivate the door lock and cut the electrical supply lead (immediately remove plug with spare lead). This will prevent children at play from locking themselves in (danger of suffocation) or getting into other life-endangering situations.

How to operate your machine







Setting the water hardness range — filling with dishwasher salt

Your dishwasher is fitted with a water-softening system which, from "hard", i.e. lime-containing water, makes the "soft" water necessary for dishwashing.

A special dishwasher salt is necessary for water-softening system regeneration. The salt container on the floor of the washing compartment (**Fig. 2/B**) must therefore always be full of salt. The water-softening system is automatically treated with salt at the end of every washing programme.

To ensure good economy and as a contribution to environmental protection, you should not consume more salt than is necessary. You should therefore set the hardness range corresponding to the water hardness applicable in your area.

Your competent waterworks is required to provide you with information about water hardness in your locality. Set the hardness range switch (**Fig. 2/C and Fig. 4**) e.g. with a coin to the **highest value** specified in the following chart:

Water hardness			Hardness range switch setting
Hardness-range	° dH	mmol/l	
IV	35—40	6.1—7.2	 *)
	28—34	4.9—6.0	
	22—27	3.8—4.8	
III	15—21	2.6—3.7	
II	8—14	1.4—2.5	
I	below 8	below 1.4	 no salt necessary

*) Factory setting

How to operate your machine

Use only **special dishwasher salt** for dishwashers. Never use table salt, cooking salt, cattle salt, or road salt, since these types of salt contain insoluble substances (anti-caking additives) which may choke the water-softening system.

Important! Detergent and special dishwasher salt are often sold in similar packages. Any detergent inadvertently filled in the salt container will make the water-softener unserviceable! Please make sure therefore that, before filling salt, you actually have the salt package in your hand.

The salt filling opening is located on the RH side of the dishwasher floor (Fig. 2/B).

To fill with salt, open the door, remove lower basket, unscrew the cap (cap marked with symbol ) , and place the funnel provided with the machine over the opening (Fig. 5).

Only when first starting, pour 1½ to 2 litres of water into the salt container.

Then fill salt until you can see the salt mash (capacity around 1.5 kg). Finally, clean the thread and rubber ring free of salt residues and screw the cap back on tight. Replace the lower basket.

Important!

The cover of the salt container must be tightly closed, since salt will otherwise get into the rinse water and may make your glasses cloudy.

No salt residues must be left on the base of the machine. Therefore, after filling with salt, switch on the “pre-wash programme” or wash your dishes immediately after filling with salt.

Salt replenishment indicator

You must replenish with salt when the cap shows the red mark (Fig. 6).

Filling with rinse aid

The rinse aid ensures that the last rinse water flows off, leaving no drops, and gives your crockery its final sparkle. The rinse aid is dispensed automatically from the dispenser.

Important!

Use only a branded rinse aid for domestic dishwashers, since other agents, e.g. vinegar (with an acid concentration greater than 5%), may damage your machine and not produce the desired effect.

Never use conventional washing-up liquids, since they contain agents causing heavy frothing and are unsuitable for dishwashers.

The dispenser is located on the inside of the door (Fig. 2/E). Open the dispenser by twisting the cap ¼ revolution to the left (Fig. 7/arrow) and fill the rinse aid into the filling opening max. up to the dotted line (Fig. 8).

Then close the cap again by twisting it to the right.

Filling quantity is around 150 cm³ (sufficient for around 50 washing programmes).

Wipe off any spilled rinse aid with a cloth, otherwise too much foam will be produced during washing.

Rinse aid replenishment indicator

You must replenish with rinse aid when a dark spot surrounded by a bright ring () appears in the display window on the dosage combination (Fig. 8/arrow). When the rinse aid dispenser is full, the display window appears uniformly dark.

How to operate your machine

Setting the rinse aid quantity to be dosed

The dispensing unit is located inside the filling opening (Fig. 9). You can use it to regulate the rinse aid quantity on a scale of 1—6 corresponding to 1—6 cm³ rinse aid addition.

For this purpose, set the arrow with a coin or screwdriver to the required scale position.

The rinse aid dosage is factory-set to a quantity of 3 cm³ rinse aid (arrow points to "3") per washing programme.

In individual cases, more or less rinse aid can be dispensed, but you should do this only if you discover imperfect crockery results after washing (see page 39 under "If you think your dishwasher is not working properly").

Add dishwashing detergent — before each washing programme

Before starting a washing programme (except "Extra pre-wash"), you must fill the detergent dispenser with dishwasher detergent powder or liquid (Fig. 2/D).

If the lid is closed, press the locking lever (Fig. 10/a), and the lid will spring open. The quantity of detergent used depends on the degree of soiling of the dishes.

For normal soiling, add around 20 ml when using dishwashing powder for heavy soiling, especially with starch and fat, around 30 ml. When using dishwashing liquid, add around 30 ml and 40 ml respectively.

The two marking lines in the rinse aid dispenser are intended to help you achieve the correct dosage. The lower "MIN" mark corresponds to around 20 ml and the upper "MAX" mark to around 30 ml detergent when filled level (Fig. 11). Then press the lid shut. The catch must engage.

The detergent is dispensed automatically into the machine during the washing programme.

During programmes with pre-wash, we additionally recommend you to put detergent in the cap dispenser (Fig. 10/b) (dispenser filled level).

Since the effectiveness of different detergents may vary, please also note the dosage recommendations of the detergent manufacturer concerned.

Important note:

The rinse aid dosage indicated as "MIN" and "MAX" applies to the **full** load which we recommend as being **the most economic and environmentally acceptable** method of machine dishwashing.

You may of course also wash smaller quantities of dishes — with correspondingly smaller rinse aid dosage. **E.g. for half-load, you should add only around 15 ml dishwashing powder (around 25 ml dishwashing liquid) to achieve satisfactory dishwashing results.**

Important!

- **Use only branded dishwasher detergent for domestic dishwashers.** Never use conventional washing-up liquids (they cause heavy frothing, and the dishes will not be cleaned).
- Always store the detergent in a dry place in a sealed container (lumpy detergent will not clean dishes).
- To ensure good economy and as a contribution to environmental protection, never add too much dishwashing detergent. If you add too little detergent, starch residues remain on the dishes and can only be rubbed off by hand.

Loading the dishwasher correctly

Before loading the machine with dishes, remove larger food residues that are not soluble in water, e.g. fishbones and other bones, etc. Pans with burnt-on food residues should be pre-soaked in water.

The easiest way to load the basket is from back to front.

Lower basket (Fig. 12)

Large, heavily soiled dishes are best cleaned in the lower basket. Draw out the lower basket to its fullest extent and place dishes, bowls, plates, and pots according to our illustrated example.

Cutlery basket

Cutlery should be arranged in the basket as follows:

- Arrange cutlery loosely and distribute it in all compartments so that each individual article has good contact with the washing water.
- Arrange knives, forks and spoons with their handles downwards.
- Do not arrange spoons and forks with their dirty side in contact with each other. For coffee- and teaspoons, you can use the special spoon rack on the LH side.
- Exceptionally long cutlery pieces, such as e.g. soup ladles or the like, can be placed in the upper basket (since the upper rotor arm may otherwise be obstructed).

Upper basket (Fig. 13)

Smaller, more fragile dishes are given a gentle wash in the upper basket. Draw out the upper basket to its fullest extent and insert the smaller crockery items, such as saucers, cups, glasses, and small cans according to our illustrated example. For this purpose, also use the hinged cup holders.

Important!

Proper arrangement ensures perfect washing results.

- Arrange all containers, such as cups, glasses, saucepans, etc., with the open downwards so that the water can run out freely. Make sure that no water can collect in the recesses.
- Extremely curved dishes or other items should be placed in holders with wide spacings on the LH side at the back of the lower basket so that the sprayed water has good access to all surfaces.
- Dishes, pots, and pans are best placed upside down over the short angled holders in the lower basket.
- Arrange glasses so that they are not in contact with each other (this prevents marks which may be produced during drying and also prevents glass damage).
- Hinged cup holders: arrange cups in staggered formation to ensure thorough cleaning action from all sides.

Starting and stopping — taking out the dishes

Programme start

(Turn to next page for programme chart)

1. Fully turn on water tap.

Note: Should you ever forget to turn on the water tap even though you have started your dishwasher, switch off your machine, turn on the water tap, and restart the programme from the beginning.

2. Turn programme switch (**Fig. 1/III**) clockwise to symbol **A** or **B** according to programme table.
3. Turn the programme selector (**Fig. 1/I**) to the required programme setting. The programme starts.

Programme cycle indicator

(**Fig. 1/III**)

After starting, the washing programme runs automatically.

During the programme cycle, the programme switch rotates stepwise and thereby indicates the respective status of the washing programme.

During heating for washing with detergent and final rinsing with rinse aid, the programme cycle indicator remains stationary until the required temperature is attained.

Programme correction

If you have set the wrong programme by mistake, you can immediately correct this by turning the programme button or the programme switch clockwise to the correct position.

Important!

On radio interference grounds, operate the programme switch only **when the machine is switched off**. Otherwise this could result in unintentional detergent dosage.



Programme stop

When the programme has ended:

- Turn the programme selector to the  position.
- When the rinse programme has ended, the dishes should be left in the closed dishwasher for a further 15 minutes for complete drying and cooling. Unless the dishes are then taken out, it is recommended to open the door and leave it ajar.
- First take out the dishes from the lower basket and then from the upper basket so that no water from the recesses in the crockery above can drip on to articles in the lower basket.
- Check the condition of the strainers after every washing programme. If they are choked, clean them. Turn to page 38 for cleaning instructions.

To accelerate the drying phase and cooling, the door can also be **fully** opened and left ajar when the programme has ended (note steam escape!) This is recommended, however, only if the underside of the worktop is properly protected with the aluminium foil provided.

Washing programmes

Washing programmes	Suitable for	Set programme: Turn programme switch to symbol	Turn programme selector to:
Extra pre-wash	Used crockery collected in the dishwasher and intended for washing at a later time	A	
Normal 65°C	Normally to heavily soiled tableware and cookware with dried-on food residues (especially vegetables, like spinach, carrots etc.)	A	
Economy 65°C	Short programme for normally to slightly soiled tableware and cookware	B	

Washing programmes

Programme cycle	Programme duration in minutes for cold water connection	Energy consumption (kWh) for cold water connection	Water consumption in litres
Pre-wash	11	0.1	6
Pre-wash, washing with detergent, 2 x intermediate rinse, final rinse with rinse aid, drying with hot air	73	1.6	25
Washing with detergent, intermediate rinse, final rinse with rinse aid, drying with hot air	62	1.6	17

Cleaning the strainers

Coarse strainer

Fig. 15

Remove the coarse strainer and clean it under running water with a brush. If food residues have become stuck, take out the insert (Fig. 16) and remove the food residues.

Then replace the insert firmly in the coarse strainer and place it in the fine strainer.

Fine strainer

Fig. 17

Regularly clean the fine strainer (a) and micro-filter (b) as well. Unscrew it anticlockwise and clean the top and underside of the strainer. Then replace it so that the outside edge rests correctly on the floor of the machine (i.e. forms a tight fit). Then screw on tight in a clockwise direction. **Never carry out a washing programme without a strainer.**

Care instructions

Never clean the screens and controls of your appliance with commercially available furniture cleaners and aggressive detergents.

If cleaning is necessary, use only lukewarm water.

If you think your dishwasher is not working properly

Before calling our service centre, please check whether you can rectify the fault yourself by following the instructions given below.

What should I check ?

... **does the drain pump run continuously (even when the machine is stopped)?**



- The water protection system (see page 43) has responded.
 - **First** close the water tap
 - Unplug the machine (see "Electrical Connection" on page 43)
- In this case, the service centre should **always** be called for fault-finding.

... **the programme will not start?**

- Are the fuses in order?
- Have you closed the door properly?

... **no water flows in?**

- Have you turned on the water tap?
- Check the water supply hose (it must not be kinked).

... **the programme mechanism sticks at the beginning of washing with detergent (symbol ) or rinsing with rinse aid (symbol )?**

- Have you **fully** turned on the water tap (see page 35)?
- Check the strainer on the supply hose connection (if soiled, please clean).
- Is the minimum water pressure of around 1 bar available (see page 42)?

... **the crockery is not clean?**

- Did you select the correct programme? **Remember to use a programme suitable for the nature and degree of soiling of your crockery.**
- Did you arrange the crockery in accordance with the instructions given in this manual? The sprayed water must have access to all surfaces, both internal and external. The baskets must not be overfilled!

If you think your dishwasher is not working properly

- Have the spray arms been obstructed by a piece of crockery or cutlery?
Please make sure that, for better drainage of residual water at the programme end, the upper spray arm obliquely tilts when it comes to rest. When operational, it automatically runs in the horizontal position.
 - Are the strainers clean? Did you replace the strainers properly after cleaning them?
 - Have you used sufficient detergent?
 - Check the drain hose (it must be run according to the instructions given on pages 42/43).
 - In the event of a hot-water connection (up to max. 60°C) — to ensure good economy, only to be recommended if hot water is available "virtually free of charge" — use no 50° programmes so that the detergent has a sufficiently long time to act.
 - Is there still salt in the salt container? Without salt, the water will not be softened. From 8°dH, yellow and white lime deposits will form on the dishes.
 - Was the correct water hardness setting made by the tradesman or by yourself for the water hardness range in your locality? (See also page 31.)
- ... **the dishes do not dry and have no sparkle?**
- Have you used a branded rinse aid?
 - Is there sufficient rinse aid in the dispenser? (Check rinse aid indicator on the dosage combination).
- Was the correct dosage selected?
In case of an overdosage:
If streaks, stripes, and milky shapeless marks (also blue-coloured blooms) form on the crockery, especially on glasses, too much rinse aid is being added. Therefore **decrease the dose!**
 - **In case of an underdosage:**
If dried water droplets (also greyish white drop edges) form on the crockery, especially on glasses, too little rinse aid is being added. Therefore **increase the dose!**
- ... **rust marks can be seen inside the machine?**
- The machine interior, filters, and door interior are made of stainless steel and will not rust. If rust is found on these parts, this must be from another source (rust in water, rust particles from water pipes, saucepans, and cutlery). Remove the marks with a commercially available stainless steel cleaner.

Customer Service

On pages 38/39, we have listed the most important faults which you can remedy yourself.

- If you nevertheless wish to call in our service engineer to eliminate one of the above faults or a fault resulting from incorrect operation, we should like to draw your attention to the fact that repairs are not carried out free of charge even during the warranty period.
- You are therefore strongly advised to adhere to the instructions given in this manual and also to follow our additional tips and recommendations.
- If you find that this instruction manual cannot help you in detecting and eliminating a particular fault, then please call the service centre.
- **Our electrical appliances comply with the valid safety requirements. Repairs to electrical appliances should only be performed by a trained electrician. Improper repairs may place the user at serious risk.**
- **Never operate your dishwasher if**
 - the electrical supply lead is damaged
 - the machine is visibly damaged in the control panel, on the worktop, or in the plinth area.

When calling the service centre, please state the

E-number (product number) and the

F-number (serial number)

which are given on the rating plate (**Fig. 2/G**). Your indication of these numbers enables the after-sales service to make precise identification of the required spare parts so that your dishwasher can be repaired at the engineer's first visit.

You will thus save yourself additional costs due to any possible repeated trips by the service engineer.

Notes on installation

Installation

See the attached Installation and Connection Instructions as well as the separate Installation Instructions for integrated appliances.

Water supply

This dishwasher is equipped with a safety valve (solenoid valve) directly on water tap, see also page 43. To assure the operation of this safety device, the double wall supply hose must be connected to the outlet valve (water tap) in a specific installation position.

Please therefore also note the separate "Safety valve on water tap" connection instructions.

Your dishwasher has been built in accordance with the valid regulations governing water-consuming appliances and is equipped with safety devices which prevent used water from flowing back into the drinking water mains. Your dishwasher can be connected to either a cold or hot water supply of max. 60°C, **but not to open hot water appliances and through-flow heaters.**

The supply hose is fitted with a screwed hose connection (to DIN 259) and can be connected to an outlet valve (water tap) with male thread (3/4").

Suitable washers are supplied with the machine. Do not use any washers other than these! The nut of the screwed hose connections can be tightened by hand.

If you require a supply hose which is longer than the one supplied, use only the VDE-approved complete hose kit continuously and to adequate length.

Never lengthen existing hoses.

Notes on installation

Water supply

Important note:

On appliances with a safety valve on the water tap, extension can also be made with a copper pipeline (8—10 mm dia.) arranged as a fixed installation.

To avoid reductions in water supply to the kitchen, we recommend you to install a separate tap. Failing this, fit a branch piece to the existing water tap.

Minimum water pressure:

around 1 bar (1 atm overpressure, 1 kp/cm², 10 N/cm², 100 kPa). If your water pressure is under 1 bar, please ask our service centre for advice.

Maximum allowable water pressure:

around 10 bar (10 atm overpressure, 10 kp/m², 100 N/cm²). For water pressure over 10 bar, a pressure reducing valve (obtainable from your dealer) must be fitted upstream.

Water drainage

The transport packing for the supply and drain hoses consist of a plastic tape and fastening wire. Remove both before first use and place the drain hose in the plinth recess (**see Fig. 3/b**).

The hose connection (19 mm dia.) supplied with the dishwasher will fit all commonly available makes of sink trap. Secure the hose with the supplied hose clip.

Notes on installation

Water drainage

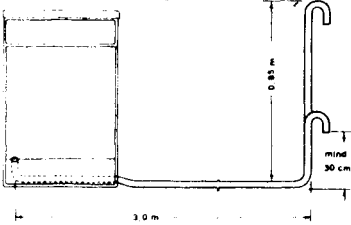

Your dishwasher is equipped with a pump which serves to pump out the used washing water and is controlled by the programme. It pumps the used washing water through the drain hose up to a height of 1 m, up to max. 85 cm above floor level for a horizontally laid hose extension of max. 3 m (see illustration).

Water protection system

To protect your dishwasher from water damage, it is equipped with a water protection system.

Apart from an overflow protection, which prevents uncontrolled rising of water in the appliance, it also features an outlet protection (float switch in the floor tray). This responds in the event of any untightness in the machine.

The double-walled supply hose is additionally monitored by the safety valve directly on the water tap.

Suitable extension hoses with 19 mm inside diameter can be ordered from your retailer or from our service centre. Product liability is retained when an original extension hose is used.

The inside diameter of these extension hoses must be 19 mm so that appliance operation is not impaired.

The drain hose is run from the rear of your dishwasher. It can be laid in the plinth recess either to the right or left of the machine.

Caution! The hose must not be kinked, squashed or twisted. Please also note:

The inlet height must be at least 30 cm above the bottom edge of the machine.

If the hose is connected directly to a sink trap, the inside diameter of the sink trap connection may not be less than 15 mm.

Electrical connection

According to the technical connection conditions of the Electricity Board, a **fixed connection to the mains supply may only be made by an approved electrical installer.**

Details of the electrical connection are given on the rating plate. This is located on the RH inner edge of the door. If the machine is convertible, the changeover diagram directions given on the mains junction box must also be observed.

Comply with the VDE Specifications when connecting the machine and also where necessary with the local regulations of the electricity authority.

In all cases of malfunction, the water supply is immediately interrupted and the drain pump switched on. **The pump also operates even if the machine is switched off.**

This prevents water from either flowing out or overflowing. Any residual water in the appliance is automatically pumped away. A fault is recognizable by the fact that a pump noise is heard when the machine is **switched off.**

If a fault occurs, **first close the water tap.**

Then fully isolate the machine from the mains supply by unplugging it.

During appliance connection, it is essential to ensure that the nominal voltage specified on the rating plate is the same as the mains voltage at the place of installation.

To disconnect the automatic dishwasher from the mains supply, pull out the plug. Should the appliance have a "fixed wiring connection" with the mains supply, it must be disconnected by appropriate measures on the fixed wiring side (fuses — to be unscrewed —, automatic cutout, spurious current protection switch, or the like which have a contact opening width > than 3 mm).

Technical data

Capacity as per IEC Publ. 436

12 standard place settings
including serving utensils

The consumption data stated in this manual refer to the reference programme "Normal 65 °C".

Water pressure:

Min. 1 bar (= 10 N/cm² = 0.1 MPa)
Max. 10 bar (= 100 N/cm² = 1 MPa)

Detergent dosage:

5 g in pre-wash sequence
20 g in wash sequence
(IEC-detergent)

This appliance is radio interference suppressed in accordance with EC Directive 82/499 EC, EN 55014/DIN VDE 0875 Part 1, Dec. 1988, as well as with the Standard relating to the Retroactive Effect on the Mains Supply EN 60555 Parts 1—3/ DIN VDE 0838 Parts 1—3, June 1987.

Examples of crockery arrangement for 12 standard place settings including serving utensils to IEC Publ. 436

Figs. 12 and 13

12 place settings:

12 soup plates of around 24 cm dia.
12 dinner plates of around 24 cm dia.
12 dessert plates of around 19 cm dia.
12 teacups of around 9 cm dia.
12 saucers of around 14.5 cm dia.
12 drinking glasses of around 7 cm dia.
and around ¼ l capacity
12 knives
12 forks
12 spoons
12 teaspoons
12 dessert spoons

Serving utensils:

1 oval platter of around 37.5 x 26 cm
1 round bowl of around 21.5 cm dia.
and around 10 cm depth
1 round bowl of around 17 cm dia.
and around 7.8 cm depth
1 dish of around 15 cm dia.
1 serving fork
2 serving spoons
1 gravy ladle

AEG Hausgeräte AG
Postfach 10 36
D-90327 Nürnberg

© Copyright by AEG

H 246 253 100 -- 0294 5 /31