

MICROMAT-DUO 21TG - d/w

Microwave Oven

Operating Instructions

INSTALLATION

1. Ensure that all packing materials are removed from within the oven cavity.
2. Inspect the oven after unpacking for any visual damage such as:
 - Misaligned Oven Door
 - Damaged Oven Door
 - Dents or Holes in Oven Window and Screen
 - Dents in CavityIf any of the above are visible, DO NOT use the oven, and report the damage to your AEG dealer.
3. This Microwave Oven Micromat-Duo 21 TG d/w weighs 17 kg and must be placed on a horizontal surface that is strong enough to support this weight.
4. The oven must be placed away from high temperatures and steam.
5. DO NOT install above a heat source.
6. DO NOT place anything on the oven.
7. Keep the oven at least 5 cm away from both side-walls, 10 cm away from the underside of an overhead kitchen cupboard, and 10 cm away from rear wall to ensure the correct ventilation.
8. As with any appliance, close supervision is necessary when used by children.

■ PLUG CONNECTION

If the socket outlets in your home are not suitable for the plug supplied with this product, it must be cut off and an appropriate one fitted. Destroy or dispose of safely the plug that has been cut off as there is a shock hazard from the exposed wires if it is inserted into a 13 A socket outlet. Never use the plug without the fuse cover fitted: replacement are available from AEG (0753/87 2550). The correct cover is identified by the markings and / or colour of the insert on the base of the plug. Only fit a 13 A fuse which is approved by BSI or ASTA to BS 1362. If fitting a replacement plug take note of the following.

WARNING — THIS APPLIANCE MUST BE EARTHED.

■ IMPORTANT

The wires in this mains lead are coloured in accordance with the following code:

Green-and-yellow : Earth Blue : Neutral Brown : Live

As the colours of the wires in the mains leads of this appliance may not correspond with the coloured markings identifying the terminals in your plug, proceed as follows:

The wire which is coloured green-and-yellow must be connected to the terminal in the plug which is marked with the letter E or by the earth symbol \perp or coloured green or green-and-yellow.

The wire which is coloured blue must be connected to the terminal which is marked with the letter N or coloured black.

The wire which is coloured brown must be connected to the terminal which is marked with the letter L or coloured red.

1. The power cord is 1.1 m long, the socket should be within easy reach of this cord.
2. If the appliance is not connected through a plug and socket, then a double-pole switch must be provided in the installation.
3. If you have any doubt about the connection of your oven, consult a qualified electrician.

Do not operate this oven if it has a damaged cord or plug, if it is not working properly, or if it has been damaged or dropped.

Do not immerse cord or plug in water. Keep cord away from heated surfaces. Do not let cord hang over edge of table or work surface.

CAUTION

1. Please remember that in the microwave mode the oven only heats the liquid in a container rather than the container itself. Therefore, even though the lid of a container is not hot to the touch when removed from the oven, please remember that the food/liquid inside will be hot and will release the same amount of steam and/or spitting when the lid is removed as in conventional cooking.
2. Always test the temperature of cooked food yourself especially if you are heating or cooking food/liquid for babies. It is advisable never to consume food/liquid straight from the oven but allow it to stand for a few minutes and stir liquids to distribute the heat evenly.
3. Food containing a mixture of fat and water, e.g. stock, should stand for 30 — 60 seconds in the oven after it has been turned off. This is to allow the mixture to settle and to prevent bubbling when a spoon or stock cube is added to the liquid.
4. When heating or cooking foods with a high fat or sugar contents do not use plastic containers.
5. Cooking utensils may become hot because of heat transferred from the heated food. This is especially true if plastic wrap has been covering the top and handles of the utensil. Oven gloves may be needed to handle the utensil.
6. Do not use recycled paper products in this oven. Impurities in these products can cause arcing.

This book is your guide to the use and care of your AEG Microwave Oven.
Please take time to read it before you operate the oven.

Contents

Getting Ready

INSTALLATION	1
CAUTION	2
IDENTIFYING THE OVEN	
PARTS	3 - 5
OPERATION/RESULT	6
TO SET TIME OF DAY	7

Basic Operation

MICROWAVE COOKING	
- MANUAL	8
- AUTO REHEAT	9 - 10
- BEVERAGE REHEAT	11
- AUTO DEFROST (TIME)	12
- WEIGHT DEFROST	13 - 14
- WEIGHT COOK	15 - 16
GRILL COOKING	
- GRILLING	17
- COMBINATION GRILL COOKING	18

Application

PRE-SET FUNCTION	19
MEMORY KEY	20
KITCHEN TIMER	21
CHILD PROOF	21
PROGRAMMING	
COMBINATIONS	22

Warning and Additional Information

WARNING	23
CLEANING AND MAINTENANCE	24
BEFORE YOU CALL FOR	
SERVICE	24
SPECIFICATIONS	25

Appearance

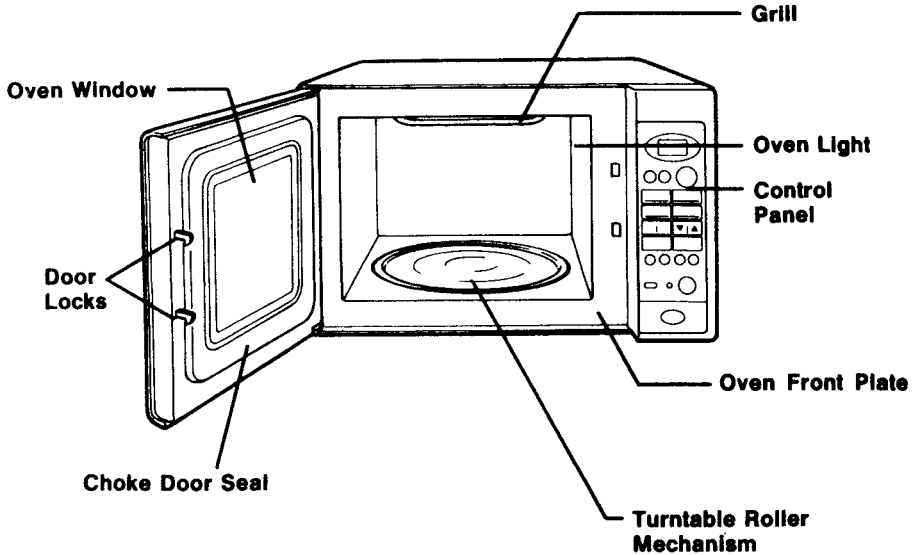

Accessories

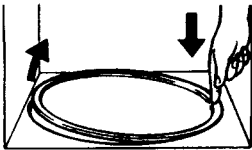

A. Turntable Tray (glass) — It rotates clockwise or anti-clockwise during cooking. To remove the turntable, push the rim down and lift out.

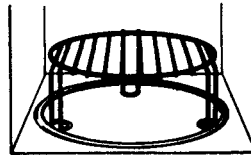

B. Grill Rack — Place onto turntable tray for grilling, and combination grilling. Do not use in the microwave.

CAUTION

- DO NOT remove the turntable tray when any item of food or any dishes etc., are placed on it.
- Remove with care as the turntable tray can get hot during cooking.

Control Panel

Fluorescent Display

Indicates the time, weight of food and other oven features.

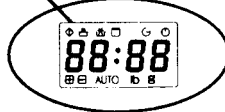

Cooking Selection Pads

used to select Grill or Combi Grill cooking methods.

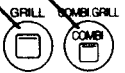

Microwave Auto Pads

used to select Auto function

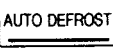

Memory Pad

Clear Pad

used to clear all information previously put into oven control panel except clock and memory.

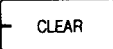
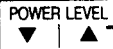
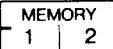

Microwave Power Level Pads

used to set desired power level

Start Pad

used to start selected operations except clock and memory

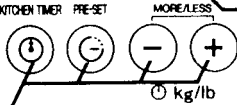

Other function pads for your convenience

- Kitchen Timer
- Pre-set
- Kg/lb Conversion
- Clock
- More/Less

Time/Weight Setting Dial

used to set time and weight of food



Door Opening Button

Push to open the door.

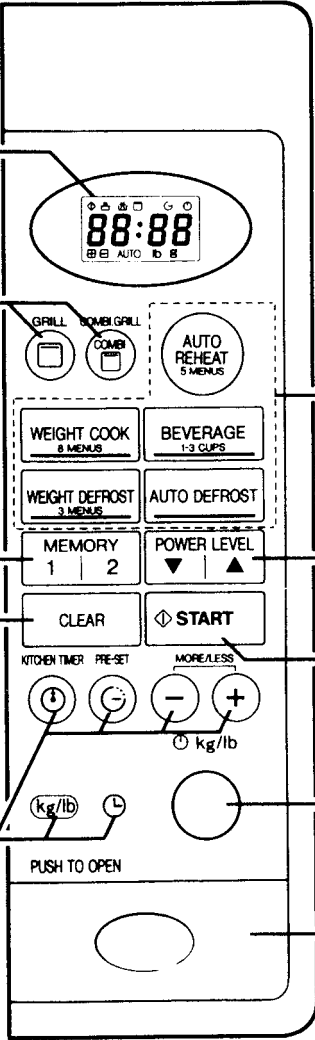

Display window

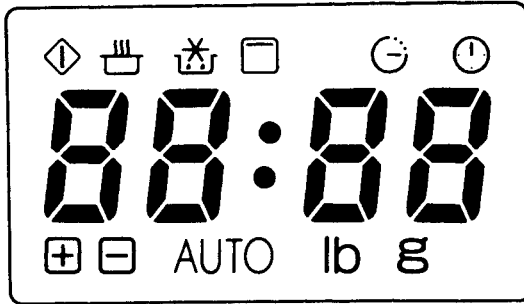

Meaning of Display

88:88: Fluorescent display shows cooking time, time of day, weight and other information.

◇ : START

☰ : MICROWAVE

❄ : DEFROST

☐ : GRILL

⌚ : PRESET

⌚ : TIME

⊕ : MORE

⊖ : LESS

AUTO : Automatic Function

lb g : Weight Indication

Guide Sign Function

To assist you in programming the oven easily, the next operation for you to use is indicated in the display window. The followings are some examples.

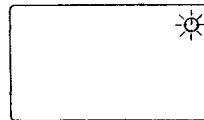

- Turn Dial to set Cooking Time or Time of day.

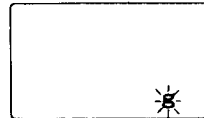

- Turn Dial to set the weight of food.

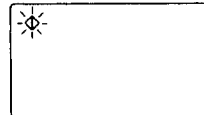





- Touch ◇ START pad to start cooking.

NOTE

Each Pad and Dial has the symbol mark which is exactly the same as the symbols in the display.

OPERATION/RESULT

Your AEG Microwave Oven is easy to operate.

OPERATION	RESULTS
1. Push the "PUSH TO OPEN" button	
2. Place the food, or food in its container, on the Turntable Tray.	
3. Close the door. The latch will snap shut, automatically locking the door. If the door is not closed properly, the oven will not start.	
4. Set the Oven Control, as instructed on the next pages.	
5. Touch the  pad.	The oven will start cooking, and the Cooling Fan, Turntable Tray, Oven Light and Cook Indicator Display will come on.
6. End of Cooking Cycle: The Timer switches off.	The beeper will sound three times. The oven will automatically shut off, and the Cooling Fan, Turntable Tray, Oven Light, the Cook Indicator Display will turn off, and Clock will reappear on the display.
7. During cooking 1) Open the door during cooking.	The oven will automatically shut off. The Cooling Fan, Turntable Tray and Oven Light will turn off and the Cook Indicator Display will stop at the cooking time remaining. The oven will not restart until the door is closed and the  pad is pushed again.
2) Touch  pad during cooking.	The oven will automatically turn off; the Cooling Fan, Turntable Tray Oven Light and the Cook Indicator Display will turn off. To resume cooking the Oven must be reset.
3) If the following pads are touched during cooking. -  pad -  pad - Other pad	Power level in cooking is displayed for 5 seconds and automatically returned to cooking. Time of day is displayed for 5 seconds and automatically returned to cooking. does not act.

NOTE

When you place the Turntable Tray into the oven, ensure the Turntable Roller Mechanism is in position. Always ensure that the Turntable Roller Mechanism is installed correctly. Place the tray onto the Turntable Roller Mechanism. DO NOT forcibly rotate the Turntable Tray. When cooking several individual items, such as potatoes, they can be placed directly on the tray leaving an equal space between them for cooking.

Example: 18:30 24hr clock

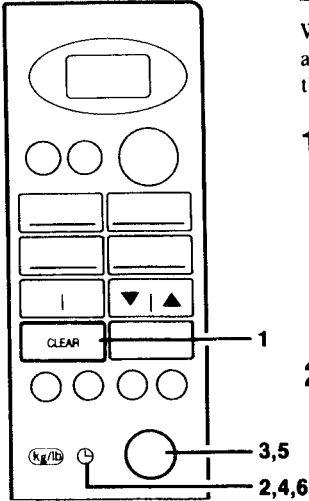

When the oven is plugged in, all indicators will appear in the display window.

1. Touch **CLEAR** pad.
"0" will appear on display.

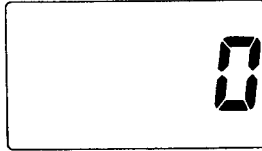

2. Touch **+** pad.
"00" will flash on left of display.

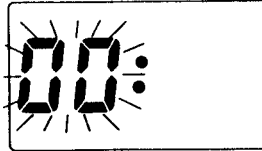

3. Turn DIAL to set hours.

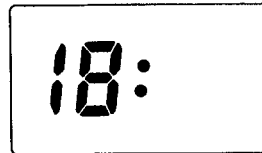

4. Touch **+** pad.
"00" will flash on right of display.



5. Turn DIAL to set minutes.

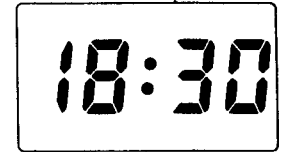

6. Touch **+** pad.
 - Time of day is now set.
 - 2 dots between the hour and the minutes will flash every other second:

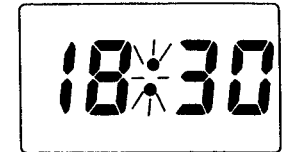

NOTE

- To reset the time of day, repeat the steps from 2 given above.
- To check time of day while oven is operating, touch the **+** pad and the time will be displayed for 5 seconds.

MICROWAVE COOKING

MANUAL MICROWAVE COOKING

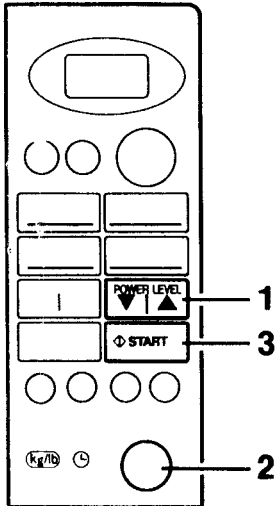

Note:

- To ensure the best microwave and defrosting results, be sure to start with a cool oven. This is important if the grill mode has been used prior to microwave cooking. Let the oven cool for 15 — 20- minutes with the door slightly open.
- This oven has 9 power levels.
If power Level ▼ is touched, P9 will appear and will count down.
If power Level ▲ is touched, P1 will appear and will count up.
- The timer can be set for up to 95 minutes.
- Should a mistake have been made in setting the timer or power level, touch the **CLEAR** pad and start again.
- Should food be cooked and removed from the oven, before the set time is completed (i.e. 1 min. still shows on the display) touch the **CLEAR** pad before cooking a further item.
- If a mistake in the power level or time setting is noticed before cooking has started, the values can be reset. If the mistake is noticed after cooking has

Example: Set oven to cook at power level 9 for 8 minutes.

1. Touch **POWER LEVEL** pad
Power Level ▼ pad Count down from "9" press once.
Power Level ▲ pad Count up from "1" press 9 times.
 and "P9" will light up and will be flashing.

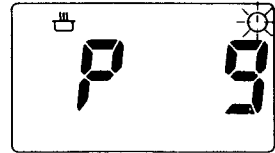

2. Turn DIAL to set cooking time.
Cooking time you set will appear and will be flashing.

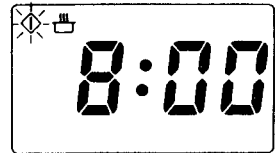

3. Touch **START** pad to commence the cooking operation.
The oven will count down the time on the display in seconds.

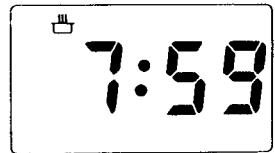

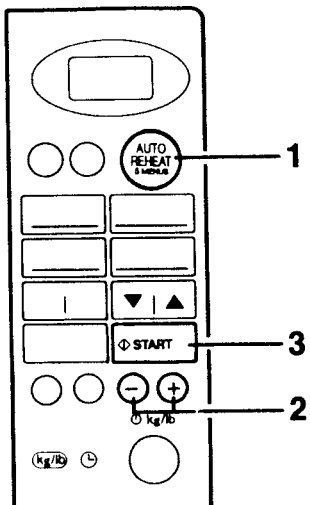

How to set Auto Reheat

1. Touch  pad to select your desired menu.



Touch	
once	Small Plated Meal
twice	Large Plated Meal
three times	Jacket Potato
four times	Pies/Pasties
five times	Casserole

e.g. A5

Menu number, , and AUTO will appear and

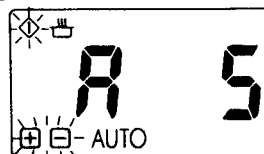
 and  will be flashing.



2. If you wish to reheat food for a longer or shorter time, touch  or  to adjust reheating time.

e.g.  twice

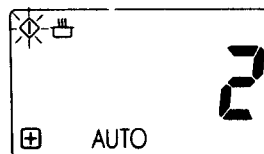

■ Auto Reheat Menu Guide

Touch

once	Small Plated Meal
twice	Large Plated Meal
three times	Jacket Potato
four times	Pies/Pasties
five times	Casserole

3. Touch  **START** pad.

The oven will count down the time for the program being used.

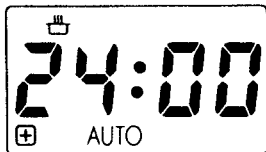

NOTE

- The display will be repeated A1-A2-A3-A4-A5 and back to A1 by touching  **AUTO REHEAT** pad.
- Food should be covered with pierced microwave cling film or a tight fitting lid.
- Liquids should be reheated uncovered.
- Items in foil trays/containers should be transferred to microwave safe dishes.
- Allow program 1, 2, 4 to stand for 1 minute before serving.
- Allow program 5 to stand for 3 minutes before serving.
- Ensure all food is thoroughly reheated before serving; continue cooking manually, if foods are not completely heated after Auto program.

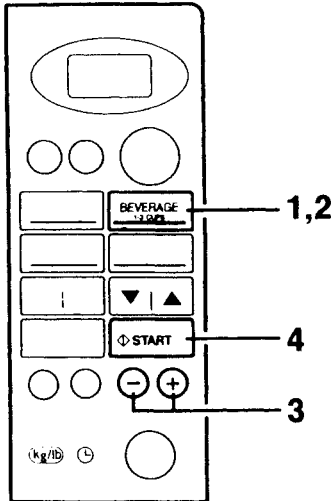

NOTE

- Preprogrammed amount for one cup in this programme is 150 ~ 225 ml. If you wish to reheat more or less amount than this, use (+) or (-) pad to adjust reheating time.
- The display will be repeated CUP1 - CUP2 - CUP3- and back to CUP1 by touching pad.
- Beverages should be reheated uncovered.

When heating liquids, e.g. soups, sauces and beverages in your microwave oven, overheating the liquid beyond boiling point can occur without evidence of bubbling. This could result in a sudden boil over of the hot liquid. To prevent this possibility the following steps should be taken:

1. Avoid using straight-sided containers with narrow necks.
2. Do not overheat.
3. Stir the liquid before placing the container in the oven and again halfway through the heating time.
4. After heating, allow to stand in the oven for a short time, stirring again before carefully removing the container.

How to set BEVERAGE Reheat

1. Touch pad.

"CUP1" , and "AUTO" will appear and and will be flashing.

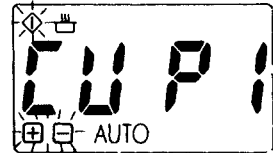

2. If you wish to reheat 2 or 3 cups, touch

pad, until the required number is displayed.
e.g. Cup 3



3. If you wish to adjust reheating times for longer or shorter periods press (+) for more or (-) for less. This feature can be used whether selecting 1, 2 or 3 cups.

e.g. (+) once will be flashing.

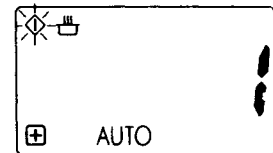

4. Touch pad.

Cooking Time will appear and start to count down in seconds.

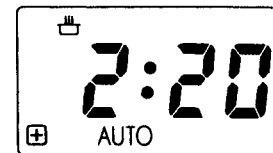

MICROWAVE COOKING AUTO DEFROST (TIME)

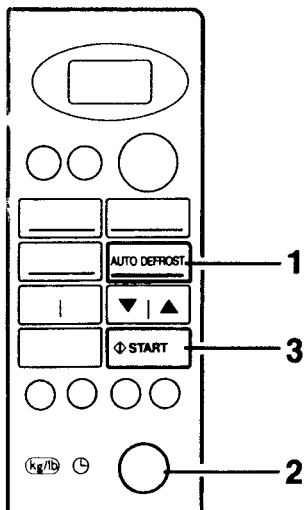

This method of defrosting uses time.



NOTE

- The "Auto Defrost" program can only be used for up to 1 lb/450g in weight.

How to set Auto Defrost

1. Touch **AUTO DEFROST** pad.
 and "AUTO" will appear and  will be flashing.

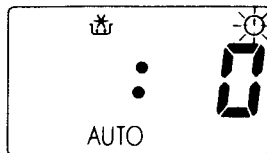

2. Turn DIAL to set the defrosting time.

e.g. 8:00

 will be flashing.



3. Touch **START** pad.
 The oven will count in the display by second



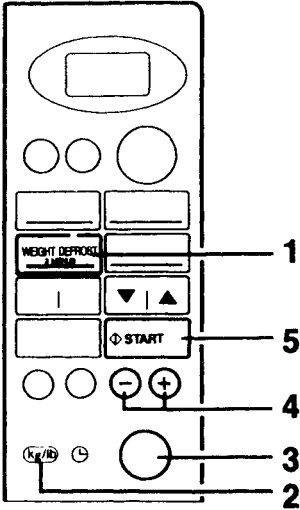

■ Weight Defrost Menu Guide

Touch
 once d1 — Poultry
 twice d2 — Meat
 three times d3 — Fish



How to Set Weight Defrost

1. Touch **WEIGHT DEFROST** pad to select your desired menu.

Touch
 once d1 — Poultry
 twice d2 — Meat
 three times d3 — Fish
 e.g. d3

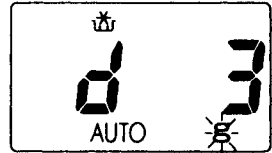
Menu number, , and "AUTO" will appear and "g" will be flashing.



2. If you wish to set weight of food by "lb", touch  pad. Then "g" on display will change to "lb" and you can use lb until you touch  pad again or if the oven is disconnected from the power supply.

e.g. use lb.

"lb" on display will be flashing.

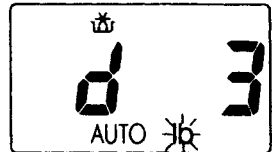

3. Turn DIAL to set the weight of food

e.g. 4 lb 1 oz

⬇ and + - will be flashing.

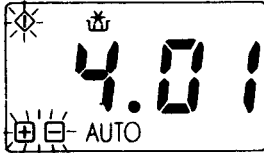

4. If you want to defrost food for a longer or shorter time, touch + or - pad to adjust defrosting time.

e.g. + once

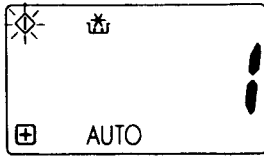

5. Touch START pad.

The oven will automatically calculate the defrosting time necessary and this will show in the display. The oven will count down time in the display in seconds.

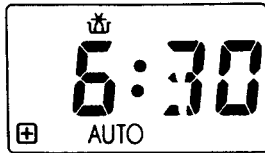

NOTE

- Maximum weight that can be set in this program is 4,000 g or 8lb 12oz.
- Place the item of food on a microwave roasting rack (not supplied with oven) or directly on the turntable.
- For good results, it is necessary to turn meat and poultry weighing more than 499g/ 1 lb 4 oz approx. during the defrosting cycle.
- For meat and poultry weighing more than 499g/ 1 lb 4 oz (approx.) allow 20 minutes standing time.
- For fish more than 499g/ 1 lb 4 oz (approx.) allow 10 minute standing time.
- Always ensure that all meat/fish/poultry is thoroughly defrosted before cooking.
- One third and two thirds of the way through the process, the oven will beep at these points, the food item should be turned or rearranged.

MICROWAVE COOKING WEIGHT COOK

This will enable you to cook a selection of food by weight using the 8 programs.

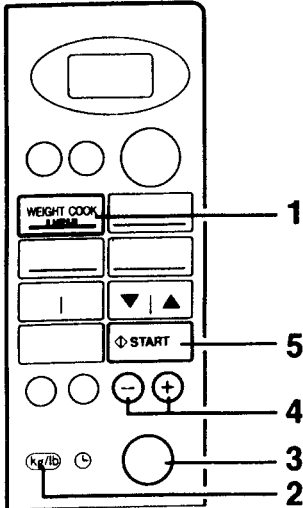

Weight Cook Menu Guide

Touch	
once	Chicken
twice	Jacket Potatoes
three times	Beef Well
four times	Beef Med
five times	Beef/Lamb Rare
six times	Lamb Med
seven times	Lamb Well
eight times	Pork

How to set Weight Cook



1. Touch **WEIGHT COOK** pad to select your desired menu.

Touch	Chicken
once	Jacket Potatoes
twice	Beef Well
three times	Beef Med
four times	Beef/Lamb Rare
five times	Lamb Med
six times	Lamb Well
seven times	Pork
eight times	

e.g. C8

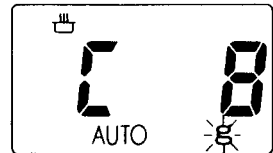
Menu number,  and "AUTO" will appear, and "g" will be flashing.



2. If you wish to set weight of food by "lb", touch  pad. Then, "g" on display will change to "lb" and you can use "lb", until you touch  again or the oven is disconnected from the mains power.

e.g. Use "g"

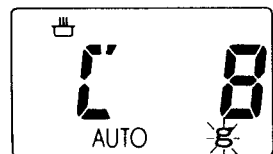

3. Turn DIAL to set the weight of food.

e.g. 950g

⬇️ and + - will be flashing.

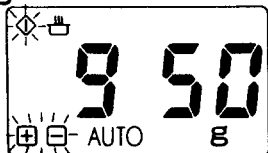

4. If you wish to cook food longer or shorter, touch + or - pad to adjust cooking time.

e.g. + once

⬇️ will be flashing.

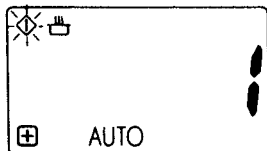

5. Touch **START** pad.

The oven will automatically calculate the cooking time necessary and this will be shown up in the display. The oven will count down the time in the display in seconds.

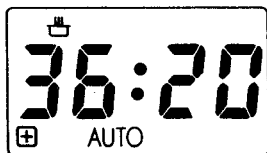

NOTE

- Maximum weight that can be set in this program is 4,000 g or 8lb 12oz.
- Cook meat/poultry on a microwave roasting rack (not supplied with oven) or directly on the turntable.
- Cover all meat/poultry with a split roasting bag.
- The oven will beep half way through the cooking cycle. The food item should be turned or rearranged.
- For program 2 — (a) Prick potato skins.
(b) Wrap each potato in kitchen paper (not recycled)
(c) Place potatoes on turntable.
(d) Do not cook any more than 4 medium sized potatoes at any one time.
- Allow 20 minutes standing time for meat/poultry over 450g.
- Allow 5 minutes standing time for meat/poultry under 450g.
- Always ensure that meat/poultry are cooked thoroughly, continue cooking manually, if the desired result is not achieved after the Weight Cook Program
- In case the door is not opened to turn or rearrange the food half way through the cooking cycle, the oven will stop and count down ten seconds. The oven will restart automatically after ten seconds.
- The display will be repeated C1, C2, C3, C4, C5, C6, C7, C8 and back to C1 by touching **WEIGHT COOK** pad.

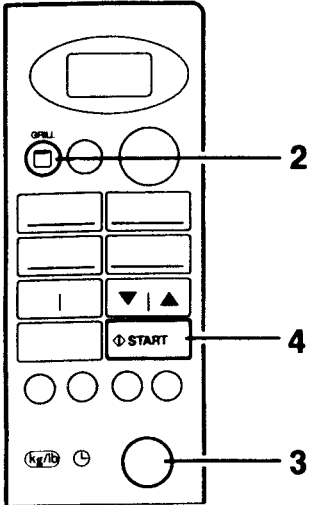

GRILL COOKING GRILLING

This will enable you to grill or brown your favourite dishes.



How to set Grilling

1. Place the food to be grilled on the grill rack on the turntable tray.

2. Touch  pad.
Grill Indicator  will appear and  will be flashing.

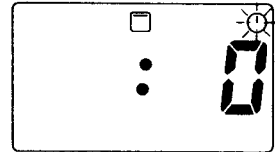

3. Turn DIAL to set the cooking time.

 will be flashing.
e.g. 8 minutes



4. Touch  pad.

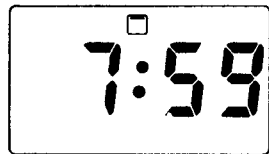

The oven will count down the time in the display in seconds.



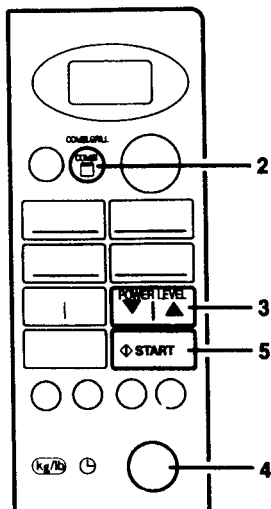

How to set Combi-Grill Cooking

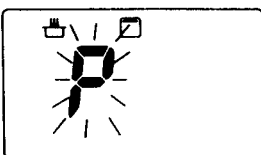

1. Place the food to be cooked on grill rack on the turntable tray.

2. Touch  pad.
Grill  and  will appear and "P" will be flashing on display.



3. Touch   pad to select power level for microwaving.
e.g. PL8

 will be flashing.

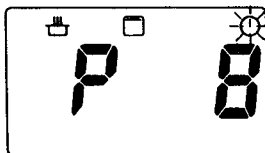

4. Turn DIAL to set the cooking time.
e.g. 8 minutes

 will be flashing.

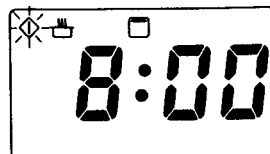

5. Touch  pad.

The oven will count down the time in the display in seconds.

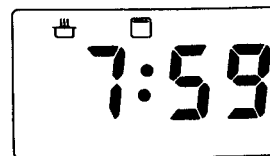

PRE-SET FUNCTION

This oven has Pre-Set feature which means the oven can be set to delay the start of the cooking process.

How to set the Pre-Set function (e.g. Set Preset Time 19:30 to cook on PL 5 for 5 minutes.)

1. Touch  pad. "00" will flash on the left of display.

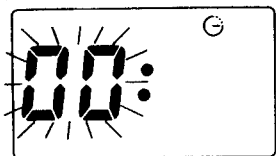

2. Turn DIAL to the required no. of hours to start program.

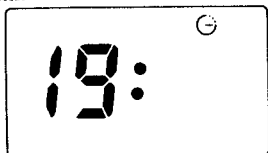

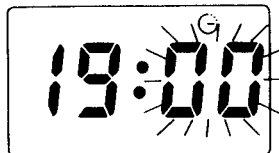

3. Touch  pad. "00" will flash on the right of display.



4. Turn DIAL to the required no. of minutes to start program.
 will be flashing.



5. Touch  pad.
 and Time of day will appear.

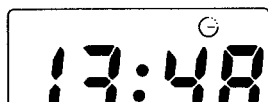

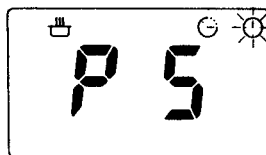

6. Touch  pad to set PL 5.
 will be flashing.





7. Turn DIAL to set cooking time 5 min.
 will be flashing.

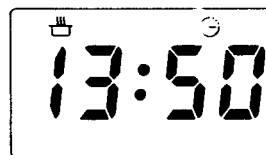

8. Touch  pad. Then, the above program is preset.
Time of day, selected cooking symbol, and  will appear on display.



NOTE

- Because the oven is set to start at a specific time of day, the clock must always be correct.
- If the oven door is opened,  pad must be touched again after closing the door. So that the oven will start at the preset time.
- If it is necessary to reset the preset time, touch the  pad and start again.
- If it is necessary to cancel the preset time, touch the  pad.

1. This oven has two memory functions.
2. Each of these memory functions [1] [2] can store 2 separate programs, (e.g. Auto Defrost — Microwave Cooking — Grill) or to store any individual program.
3. The memory functions are designed for convenience when repeating the same program.

How to set the Memory

Example: Set the following program in MEMORY [1]

Microwave cooking
Power Level: 9 → Grilling 30 minutes
Cooking Time: 10 min.

1. Touch **POWER LEVEL** pad to set PL9.
Ⓜ will be flashing.

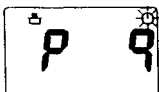

2. Turn DIAL to set cooking time 10 min.
Though Ⓜ will be flashing, go to the next step.

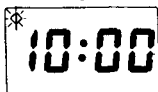

3. Touch **ON** pad.
Ⓜ will be flashing.



4. Turn DIAL to set grilling time 30 min.
Though Ⓜ will be flashing, go to the next step.

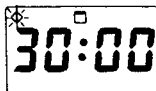

5. Touch MEMORY [1]. 1 will appear in the display
Now the above program is set into MEMORY [1] and set into Memory [1] and time of day will appear in the display window.

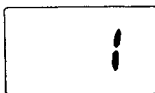

NOTE

- If you want to set some program in MEMORY [2], follow the above step in same way.
- When the oven is unplugged or the power supply is switched off, the memory will be erased and need to be reset.
- Memory will not be erased by the clear pad.

How to store a new program.

1. Set the new program required.
2. Touch any of the memory pads [1] [2] and the new program will be retained; whatever was previously stored in that memory will be erased.

How to use Memory (e.g. Memory 1)

1. Touch MEMORY [1] pad.
Then, the program which is set into memory 1, will appear two seconds in each in the display.

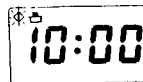
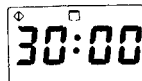
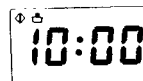
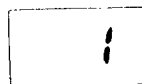

Two
seconds
in each



Application

2. Touch **START** pad.
The oven will operate using the program set into MEMORY [1].

KITCHEN TIMER

This will enable you to use the kitchen timer independently of the microwave oven.

How to set Kitchen Timer

1. Touch  pad.
 will be flashing.

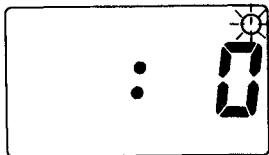

2. Turn DIAL to set your desired time.
e.g. 8 minutes
 will be flashing.

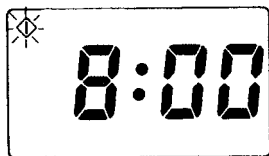

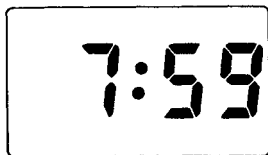

3. Touch  pad.
The oven will count down the time on display in seconds.





CHILD PROOF

To prevent misuse by children, you can lock the oven operation by this function

How to set Child Proof

Touch   at the same time.
All keys will be locked.
The oven will not operate.

How to cancel Child Proof

Touch   at the same time again.
All keys will be in normal position.

NOTE

Child Proof cannot be cancelled by touching  pad, but can be cancelled by unplugging the oven.

below and either the complete program or part of it can be used.

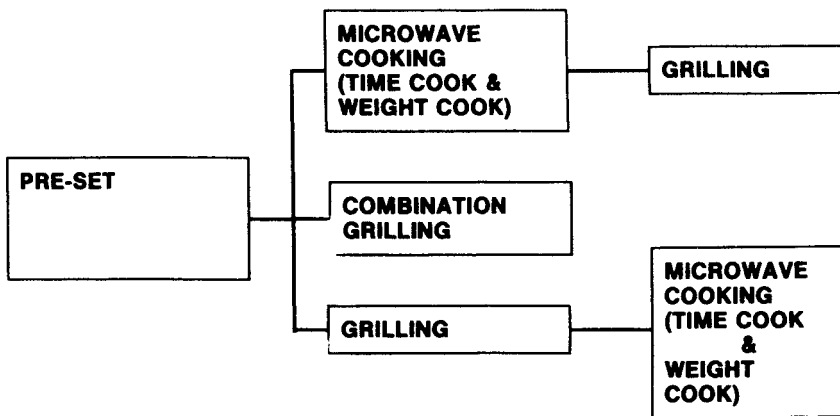
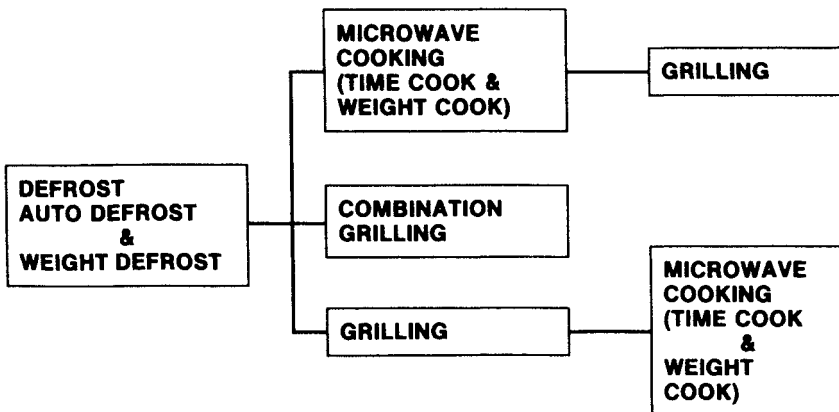

Application

WARNING

Please Read Carefully

- (a) DO NOT allow anyone to service the oven other than an Authorized AEG Service Agent. To do so will void the warranty. It is dangerous for anyone other than a service technician trained by AEG to perform repairs on it.
 - (b) DO NOT, under any circumstances, remove the outer cover, door or control panel. This too will void the warranty.
 - (c) DO NOT place any object between the front plate of the oven and the door.
 - (d) DO NOT operate the oven if the door seal is damaged or the door does not close properly. Inspect these areas for damage. If there is any damage the oven must not be operated until it has been repaired by a service technician trained by AEG.
 - (e) DO NOT operate the oven when empty, as this may damage the appliance.
 - (f) Always keep the doors seals (inside of the door and the oven front plate) clean by wiping regularly with a damp cloth and mild detergent, so that any grease, soil or spatters are not allowed to build up.
- The AEG Microwave Oven is designed to give long, safe and reliable service. With it, as with many electrical appliances, there are some basic rules to follow to assure peak performance.

Utensils

1. DO NOT use metal containers when using the microwave function as microwaves can not penetrate metal. DO NOT use utensils with gold or silver trim as these may cause arcing in the microwave oven. Porcelain or glass are suitable as containers.
2. DO NOT cook, food in a bottle or sealed container.
3. Plastic or paper containers designed for microwave use should only be used for short cooking periods.
4. Only use browning dishes or skillets specially designed for use in a microwave oven. DO NOT exceed manufacturers recommended pre-heat times.

Cooking Food

1. DO NOT cook eggs in their shells.
The expansion and build up of pressure could cause the egg to explode.
After cracking and removing the egg from the shell always pierce yolk with a fork or skewer before frying or poaching.
2. DO NOT heat oil or fat for deep frying in a microwave oven, it may overheat.
3. DO NOT cook food with a shell such as a chestnut. Make a split in the shell with a kitchen knife.
4. When heating liquids, e.g. soups, sauces and beverages in your microwave oven, overheating the liquid beyond boiling point can occur without evidence of bubbling. This could result in a sudden boil over of the hot liquid. To prevent this possibility the following steps should be taken:
 - (a) Avoid using straight-sided containers with narrow necks.

- (d) After heating, allow to stand in the oven for a short time, stirring again before carefully removing the container.
5. Avoid heating baby foods in their glass jars; transfer to a container suitable for use in a microwave oven.

Other Important Points

1. DO NOT use the oven for any other purpose than cooking. (e.g. Drying clothes).
2. DO NOT insert any object into the openings on the outer case.
3. DO NOT touch, or allow any object to cover the opening on the top of the outer case during cooking.
4. When using the grill and combination cooking, the glass door and turntable tray will get hot. It is recommended to use oven gloves.
5. DO NOT use the oven cavity for any type of storage, such as paper, cookbook, etc.
6. Never lean on the door or allow a child to swing on it when the door is open. Injury could result.
7. To reduce the risk of fire in the cavity;
 - (a) Do not overcook food. Carefully attend oven if paper, plastic or combustible material are placed inside the oven to facilitate cooking.
 - (b) Remove wire twist-ties from plastic bags before placing in oven.
 - (c) Do not use the recycled paper in this oven. Impurities in these products can cause arcing which may result in fire.
8. If materials inside the oven should ignite, keep oven door closed, turn oven off, and disconnect the power cord or shut off power.
9. This microwave oven is specifically designed to cook food and for use in homes. It is not designed for industrial laboratory use or commercial use.

MAINTENANCE

Inside the Oven

1. Oven Cavity — A combination oven can be more difficult to clean than a microwave oven due to the direct heat used in the combination. This heat will cause fat etc., to be burnt onto the cavity of the oven. After extensive tests we now recommend the following methods for cleaning.
It is best to clean the oven cavity after every use whilst still warm. Use a non-stick pan cleaner with hot soapy water. This pad is especially designed for cleaning, stainless steel and non-stick surfaces so will not scratch. If the hot soapy water with the pad is not enough use "Jif" cream with it for stubborn stains.
2. Turntable Tray and Grill Rack can be removed from the oven and washed either by hand or in the dishwasher. Handle with care — it's glass, therefore breakable!
3. Inside of Oven Door — This area is part of the sealing system which prevents microwave leakage. It is extremely important that the door be kept clean at all times.
4. Oven Front Face — This is also part of the door seal. It must be kept clean at all times.
5. For brown and burnt deposits it may be necessary to use a more abrasive product, i.e. a special microwave oven cleaner.
6. Do not use any abrasive substances on the door seals, hinges or distribution cover.

Outside the Oven

1. The Outer Casting — This is easily cleaned with a damp cloth.
2. The Door — This should be cleaned with a damp cloth. **DO NOT** use any abrasives as this may scratch the surface and impair vision into the oven.

NOTE

WHEN CLEANING, THE OVEN MUST BE SWITCHED OFF.

CALL FOR SERVICE

1. If the oven does not work at all:
Check that the oven is correctly plugged in.
Check that the wall socket is working properly by plugging in another appliance.
2. If the microwave power will not come on:
Check that the door is securely closed and the timer is set.
Unless the door is closed properly engage the safety interlocks, the microwave energy will not operate.

If there is still a problem, contact:

AEG Service Locations in the United Kingdom

AEG UK Limited

Head Office

217 Bath Road
Slough, Berks. SL1 4AW
Tel: 07 53 87 25 06
Telex: 8 47 541
Telefax: 07 53 51 22 71

AEG Scottish

Service Centre

Block 11, Unit 1
Dundyvan industria Estate
Coatbridge
Lanarkshire ML5 4AQ
Tel: 02 36 44 03 87
Telefax: 02 36 44 02 56

AEG Northern Service Centre

Unit 20, Haigh Park/
Haigh Avenue
Stockport
Gt. Manchester SK4 1QR
Tel: 0 61 4 87 22 05
Telefax: 0 61 4 74 11 91

Service Appointments

Bristol Tel: 02 72 25 28 80
(call diverted to Slough)

Norfolk Tel: 06 03 76 55 15
(call diverted to Slough)

SPECIFICATIONS

This book is your guide to the use and care of your AEG Microwave Oven. Please take the time to read it before you operate the oven.

			MICROMAT DUO 21 TG d/w
Power Supply	Frequency		50 Hz
	Voltage		240 V
Consumption	Microwave (High)		1,300 W
	Grill		1,300 W
	Combination Grill		2,550 W
Microwave	Output		High: 850 W (IEC 705)*
	Frequency		2,450 MHz
Dimensions	Outer	Height	296 mm
		Width	504 mm
		Depth	387 mm
	Inner (Cavity)	Height	207 mm
Width		315 mm	
Depth		315 mm	
Timer	Microwave		95 min.
	Grill		95 min.
	Combination		
	Grill		95 min.
Net Weight			17 kg

Radio Interference Regulations

This apparatus has been produced to comply with "EN55011" and "EN55014".

NOTE

Microwave Output Power varies by output measuring method.

Until recently almost all microwave oven manufacturers used a JIS standard to calculate microwave oven output power. From September 1990 an IEC 705 standard has been adopted; this is the common standard in Europe. If you are following recipes from food manufacturers' instructions, care must be taken to follow the correct timings.

If you are unsure, carefully check the food at the end of the stated cooking time to verify that it is properly cooked and piping hot. The IEC 705 rating will eventually be adopted by all manufacturers and cookery writers. Until this time take care to ensure all foods are thoroughly cooked.

AEG Hausgeräte AG
Postfach 1036
D-90327 Nürnberg 1

© Copyright by AEG

H 259 204 740 - 0294/02.7 - 14007 01

AEG Domestic Appliances Ltd

Customer Care Department
55-77 High Street
Slough
Berkshire SL1 1DZ

Telephone: 08705 350350