

SANTO

Built-In Refrigerators

Operating and Installation Instructions

K 9 88 00-4 i

K 9 12 00-4 i

Dear customer,

Before switching on your new appliance please read these operating instructions carefully. They contain important information for safe use, for installation and for care of the appliance.

Please keep these operating instructions for future reference. Pass them on to possible new owners of the appliance.

These operating instructions are for use with several technically comparable models with varying accessories. Please observe the notes which apply to your model.



Notes which are important for your safety or for the proper functioning of the appliance are stressed with a warning triangle and/or with signal words (**Warning!**, **Caution!**, **Important!**). Please observe the following carefully.



1. This symbol guides you step by step in the operation of the appliance.
2.



Supplementary information regarding operation and practical applications of the appliance appear after this symbol.



Tips and notes concerning economical and environmentally sound use of the appliance are marked with the cloverleaf.

Explanations of the technical terminology used in the operating instructions can be found at the end in the section "Technical Terminology".

The operating instructions contain instructions for the correction of possible malfunctions by the user in the section "What to do if ...". If these instructions should not be sufficient, contact your local Service Force Centre.

Printed on paper manufactured with environmentally sound processes
he who thinks ecologically acts accordingly...

Contents

Important Safety Instructions	4
Disposal	6
Appliance Packaging Information	6
Disposal of Old Appliances	6
Remove Transport Packaging	7
Installation	7
Installation Location	7
Your Refrigerator Needs Air	8
Installation / Power Supply	8
Electrical Connection	9
Description of the Appliance	10
View of the Appliance	10
Control Panel	11
Temperature Setting Buttons	11
Temperature Display	12
Prior to Initial Start-Up	12
Starting Up and Temperature Regulation	12
COOLMATIC	13
Switching Off the Appliance	13
Holiday Setting	14
Interior Accessories	15
Storage Shelves/Glass Shelves	15
Variable Inner Door	15
Humidity Control	16
Variable Storage Box	16
Bottle Holder	17
Correct Storage	17
Defrosting	18
The Fridge Defrosts Automatically	18
Cleaning and Care	18
Energy Saving Tips	19
What to do if ...	19
Correcting Malfunctions	19
Changing the Light Bulb	21
Noises During Operation	22
Regulations, Standards, Guidelines	22
Technical Terminology	23



Important Safety Instructions

These warnings are provided in the interests of your safety. Ensure you fully understand them before installing or using the appliance. Your safety is of paramount importance. If you are unsure about the meaning of these warnings contact the Customer Care Department for assistance.

Intended use

- The refrigerator is intended for use in the home. It is suitable for the storing of food at low temperature. If the appliance is used for purposes other than those intended or used incorrectly, no liability can be accepted by the manufacturer for any damage that may be caused.
- Alterations or changes to the refrigerator are not permitted for reasons of safety.
- If you use the refrigerator in a commercial environment or for purposes other than the cooling of foods, the manufacturer accepts no liability for any damages which may occur.

Prior to initial start-up

- Ensure that the appliance does not stand on the electrical supply cable. **Important:** if the supply cable is damaged, it must be replaced by a cable available from the manufacturer or your local Service Force Centre.
- Check the appliance for transport damage. Under no circumstance should a damaged appliance be plugged in. In the event of damage, please contact your supplier.

Refrigerant

The refrigerant isobutane (R600a) is contained within the refrigerant circuit of the appliance, a natural gas with a high level of environmental compatibility, which is nevertheless flammable.

- **Warning** - During transportation and installation of the appliance, be certain that none of the components of the refrigerant circuit become damaged.
- If the refrigerant circuit should become damaged:
 - avoid open flames and sources of ignition;
 - thoroughly ventilate the room in which the appliance is situated.

Safety of children

- Packaging (e.g. wraps, polystyrene) can be dangerous for children. There is a risk of suffocation! Keep packaging material away from children!
- Please make old appliances unusable prior to disposal. Pull out the mains plug, cut off the mains cable, break or remove spring or bolt catches, if fitted. By doing this you ensure that children cannot lock themselves in the appliance when playing (there is risk of suffocation!) or get themselves into other dangerous situations.
- Often children cannot recognise the hazards present in household appliances. It is therefore important that you ensure adequate supervision and never let children play with the appliance!

Daily Operation

- Containers with flammable gases or liquids can leak at low temperatures. There is a risk of an explosion! Do not store any containers with flammable materials such as spray cans, fire extinguisher refill cartridges etc in the refrigerator and/or freezer.
- **Warning** - Do not operate any electrical appliances in the refrigerator and/or freezer (e.g. electric ice cream makers, mixers etc.).
- **Warning** - In order not to impair the function of the appliance, never cover or obstruct the ventilation openings.
- **Warning** - Do not damage the cooling circuit.
- Before cleaning the appliance, always switch off the appliance and unplug it, or pull the house fuse or switch off the circuit breaker.
- When unplugging always pull the plug from the mains socket, do not pull on the cable.

In case of malfunction

- If a malfunction occurs on the appliance, please look first in the "What to do if ..." section of these instructions. If the information given there does not help, please do not perform any further repairs yourself.
- Under no circumstance should you attempt to repair the appliance yourself. Repairs carried out by inexperienced persons may cause injury or serious malfunctioning. Contact your local Service Force Centre.

Disposal

Appliance Packaging Information

All materials are environmentally sound! They can be disposed of or burned at an incinerating plant without danger.

About the materials: The plastics can be recycled and are identified as follows:

>PE< for polyethylene, e.g. the outer covering and the bags in the interior.

>PS< for polystyrene foam, e.g. the pads, which are all free of chloro-fluorocarbon.

The carton parts are made from recycled paper and should be disposed of at a waste-paper recycling collection location.

Disposal of Old Appliances

For environmental reasons, refrigeration appliances must be disposed of properly. This applies to your old appliance, and - at the end of its service life - for your new appliance as well.



Warning! Before disposing of old appliances make them inoperable. Remove plug from mains, sever the power cable, remove or destroy any snap or latch closures. This ensures that children do not lock themselves inside the appliance (danger of suffocation!) or place themselves into other life-endangering situations.

Disposal:

- The appliance may not be disposed of with domestic waste or bulky refuse.
- The refrigerant circuit, especially the heat exchanger at the back of the appliance, must not be damaged.
- The symbol  on the product or on its packaging indicates that this product may not be treated as household waste. Instead it shall be handed over to the applicable collection point for the recycling of electrical and electronic equipment. By ensuring this product is disposed of correctly, you will help prevent potential negative consequences for the environment and human health, which could otherwise be caused by inappropriate waste handling of this product. For more detailed information about recycling of this product, please contact your local city office, your household waste disposal service or the shop where you purchased the product.

Remove Transport Packaging

The appliance and the interior fittings are protected for transport.

-  1. Pull off the adhesive tape on the left and right side of the door.
2. Remove all adhesive tape and packing pieces from the interior of the appliance.

Installation

Installation Location

The appliance should be set up in a well ventilated, dry room.

Energy use and efficient performance of the appliance is affected by the ambient temperature.

The appliance should therefore

- not be exposed to direct sunlight;
- not be installed next to radiators or other sources of heat;
- only be installed at a location whose ambient temperature corresponds to the climate classification, for which the appliance is designed.

The climate classification can be found on the serial plate, which is located at the left on the inside of the appliance.

The following table shows which ambient temperature is correct for each climate classification:

Climate classification	for an ambient temperature of
SN	+10 to +32 °C
N	+16 to +32 °C
ST	+18 to +38 °C
T	+18 to +43 °C

Installation directly under a hob is not allowed. The temperatures of the hob, which in part are quite high, may damage the appliance.

If a hob is installed near the appliance, the corresponding installation and safety instructions must be adhered to. Considering the numerous installation conditions which are possible, there is no way of providing detailed information here.

It is necessary to avoid overheating of the refrigerator by maintaining adequate distances from heat sources and by the use of a suitable thermal insulation plate. Proper ventilation of the appliance must also be ensured.

Your Refrigerator Needs Air

Integratable models (i-appliances)

The integrated door of the furniture cabinet largely seals the installation recess. i-appliances must therefore be provided with ventilation by having an opening in the furniture plinth. The warmed air must be able to be exhausted upwards through the air shaft on the furniture back. The ventilation cross-sections should be at least 200 cm².

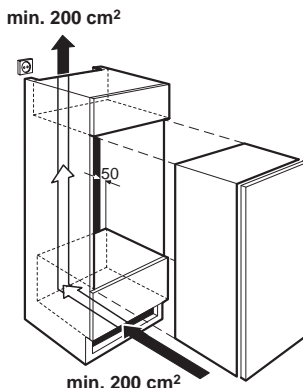

Warning - To ensure the appliance functions correctly, never cover or obstruct the ventilation openings.

Installation

See installation instructions supplied.

Please check whether, after installing your appliance and especially after reversing the door, the door seal seals right round. A badly fitting door seal may lead to heavy frosting and thereby to a higher power consumption (see also „What to do if...“).

Power Supply

A correctly installed, earthed socket is required for the electrical supply. The supply must have a fuse rating of at least 13 Amps. If the socket is not accessible once the appliance is built in, the electrical installation must include suitable means of isolating the appliance from the mains (e.g. a fused spur).



Before initial start-up, refer to the appliance rating plate to ascertain if supply voltage and current values correspond with those of the mains at the installation location.

e.g.: AC 220 ... 240 V 50 Hz or
220 ... 240 V ~50 Hz

(i.e. 220 to 240 volts alternating current, 50 Hertz)

The rating plate is inside the appliance on the left.

The mains cable may only be changed by a qualified electrician or competent person. If your appliance needs repairing, please contact your local Service Force Centre.

Electrical Connection

Any electrical work required to install this appliance should be carried out by a qualified electrician or competent person.



WARNING – THIS APPLIANCE MUST BE EARTHED

The manufacturer declines any liability should these safety measures not be observed.

Before switching on, make sure the electricity supply voltage is the same as that indicated on the appliance rating plate. The rating plate is inside, on the left.

The appliance is supplied with a 13 amp plug fitted. In the event of having to change the fuse in the plug supplied, a 13 amp ASTA approved (BS 1362) fuse must be used.

Important

The wires in the mains lead are coloured in accordance with the following code:

Green and Yellow: Earth
 Blue: Neutral
 Brown: Live

As the colours of the wires in the mains lead of this appliance may not correspond with the coloured markings identifying the terminals in your plug, proceed as follows:

1. The wire coloured green and yellow must be connected to the terminal marked with the letter "E" or by the earth symbol or coloured green and yellow.
2. The wire coloured blue must be connected to the terminal "N" or coloured black.
3. The wire coloured brown must be connected to the terminal marked "L" or coloured red.
4. Upon completion there must be no cut, or stray strands of wire present and the cord clamp must be secure over the outer sheath.



Warning! A cut-off plug inserted into a 13 amp socket is a serious safety (shock) hazard. Ensure that the cut-off plug is disposed of safely.

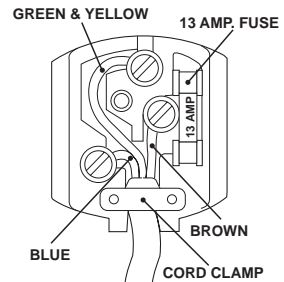

Description of the Appliance

View of the Appliance

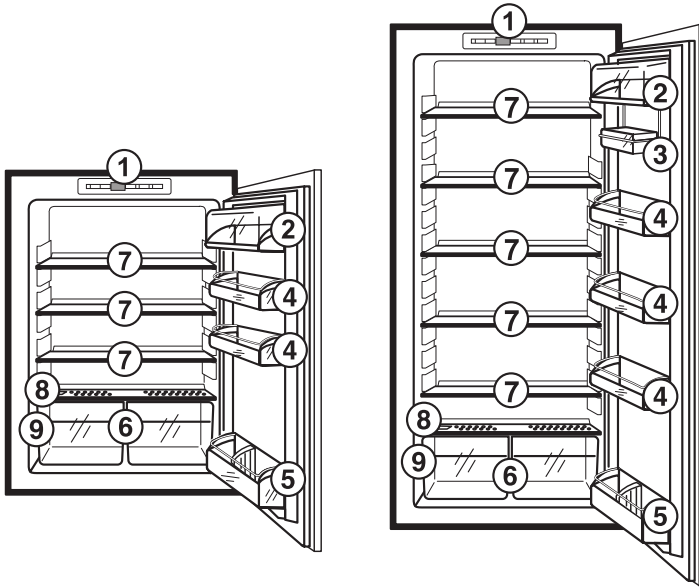

- 1 = Control panel
- 2 = Butter/cheese compartment with flap
- 3 = Variable storage box (not included with all models)
- 4 = Door storage compartment
- 5 = Bottle compartment
Bottle holder (not on all models)
- 6 = Fruit and vegetable drawers
- 7 = Storage shelves
- 8 = Moisture regulation
- 9 = Rating plate

Control Panel

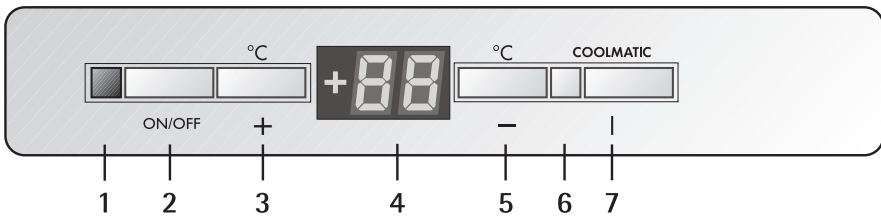

- 1 Pilot light (green)
- 2 ON/OFF switch
- 3 Temperature setting buttons (for warmer temperatures)
- 4 Temperature display
- 5 Temperature setting buttons (for colder temperatures)
- 6 COOLMATIC indicator light (yellow)
- 7 Push button for COOLMATIC

Temperature Setting Buttons

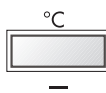
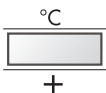

The temperature is adjusted using the „+“ (WARMER) and „-“ (COLDER) buttons.

These buttons are connected to the temperature display.

- The temperature display is switched over from the display of the ACTUAL temperature (temperature display is illuminated) to the display of the DESIRED temperature (temperature display flashes) by pressing one of the two buttons, „+“ or „-“.
- With each further press of one of the two buttons, the DESIRED temperature is adjusted by 1°C.
- If neither button is pressed, the temperature display automatically switches back after a short period (approx. 5 sec.) to the display of the ACTUAL temperature.

DESIRED temperature means:

The temperature that is required in the refrigerator, this can be adjusted to the temperatures shown in the display. The DESIRED temperature is indicated by flashing numbers.

ACTUAL temperature means:

The temperature display indicates the temperature that is currently present in the refrigerator. The ACTUAL temperature is indicated by continuously illuminated numbers.

Temperature Display



The temperature display can indicate several pieces of information.

- During normal operation, the temperature currently present in the refrigerator (ACTUAL temperature) is displayed.
- When the temperature is being adjusted, the temperature currently set flashes (DESIRED temperature).

Prior to Initial Start-Up



Please clean the appliance interior and all accessories prior to initial start-up (see section "Cleaning and Care").

Starting Up and Temperature Regulation



1. Insert the plug into the plug socket. When the refrigerator compartment door is opened, the internal lighting is switched on.
2. Press ON/OFF button.
The green mains pilot indicator illuminates.
3. Press either the „+“ (WARMER) or „-“ (COLDER) button.
The temperature display switches over and the DESIRED temperature currently set flashes on the temperature display.
4. Set the required temperature by pressing the „+“ (WARMER) or „-“ (COLDER) buttons (see section "Temperature setting buttons"). The temperature display will immediately show the changed setting. With each further press of one of the two buttons, the DESIRED temperature is adjusted by 1°C. Adjustable temperature range: +2°C to +8°C.



From a food safety point of view, +5 °C should be considered sufficiently cold for storing food in the fridge.

5. Once the required temperature has been set, after a short period (approx. 5 sec.) the temperature display will change and again indicate the current ACTUAL temperature inside the fridge. The display will change from flashing to continuous illumination.

The compressor will start and then run automatically.

Information! When the setting is changed, the compressor does not start immediately if automatic defrosting is currently taking place.



As the storage temperature within the fridge is reached quickly you can store food immediately after switching on.

COOLMATIC

COOLMATIC Button

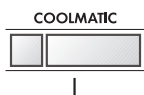

The COOLMATIC function is suited for quick cooling of large quantities of goods in the refrigerator, e.g. drinks and salads for a party.

1. The COOLMATIC function is switched on by pressing the COOLMATIC button. The yellow light illuminates.
 2. The COOLMATIC function now ensures intensive cooling. A DESIRED temperature of +2°C is automatically selected. The COOLMATIC function is ended automatically after a period of 6 hours. The originally selected DESIRED temperature is again valid and the compartment will return to. The temperature display shows the ACTUAL refrigerator temperature.
 3. The COOLMATIC function can be ended manually at any time by pressing the COOLMATIC button again. The yellow light goes out.
-  If the COOLMATIC function is switched on the temperature setting may not be changed.

Switching Off the Appliance

-  To switch off, press the ON/OFF button for approx. 5 seconds. This will result in a countdown from "3" to "1" taking place in the temperature display. On reaching "1" the fridge will switch off. The temperature display will go off.

If the appliance is not going to be used for an extended period:

1. Remove all refrigerated packages.
2. Switch off the appliance by holding down the ON/OFF button until the display goes off (see above).
3. Remove the mains plug or switch off or disconnect the electricity supply.
4. Clean thoroughly (see section "Cleaning and Care").
5. Leave the door open to avoid the build up of odours.

Holiday Setting

In the holiday mode the temperature for the refrigerator is approximately +15°C. In the holiday mode it is therefore possible to leave the door of the empty refrigerator closed during periods of extended absence.

Advantage: Unintentional closing of the door, or accidental closing of the door by persons who have access to your home during your absence, is no longer possible. Without the stand-by mode leaving the door closed would lead to the accumulation of odours and mould.

After emptying and cleaning the appliance, proceed as follows:

-  1. To activate the holiday setting, press the „+“ (WARMER) or „-“ (COLDER) button.
The temperature display will change and indicate in flashing numbers the DESIRED temperature that is currently set.
2. Hold down the „+“ (WARMER) button until the temperature display indicates H (for holiday). The temperature shown in the temperature display will change in steps of 1°C until it reaches +8°C. After +8°C the value +15°C will appear in the display with the letter H. The fridge is now operating in energy-saving holiday mode.
3. After a few seconds the temperature display will again change to the ACTUAL temperature. The display will change from flashing to continuous illumination.



To switch the fridge back to normal operation, press the „-“ (COLDER) button.

Important! Do not store any goods in the refrigerator when the stand-by mode is operational. The temperature is regulated at about +15°C when the stand-by mode is operational. This is too warm for food products.

Interior Accessories

Storage Shelves/Glass Shelves

Various glass or plastic storage shelves and wire trays are included with your appliance - different models have different combinations.

 You should always slide one of the full size glass storage shelves into the lowest set of guides, above the vegetable drawers, and keep it in this position.

The height of the storage shelves can be adjusted:

-  1. To do this pull the storage shelf forward until it can be swivelled upwards or downwards and removed.
2. Please do the same in reverse to insert the shelf at a different height.

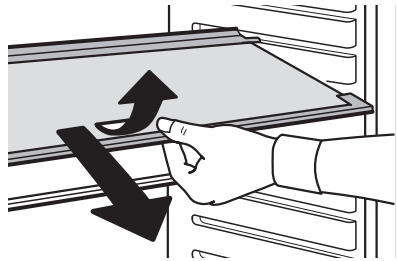

Your appliance is equipped with two half-size glass storage shelves. Storing tall items:

 Slide the front half of the Vario storage shelf in another level to the rear. By this means you will gain space to place tall items on the storage shelf below.

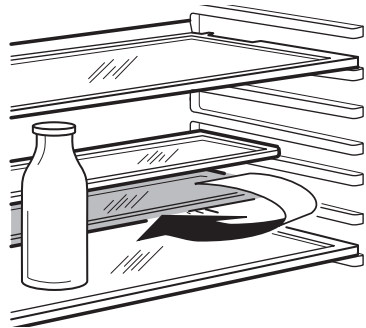

Variable Inner Door

The door compartments can be pulled up and removed, and inserted at other positions as needed.

Humidity Control

On some models, there is an adjustable air grill in front of the shelf above the fruit and vegetable compartments.

The opening in the ventilation slots can be adjusted with a slider.

Slider in right position: Ventilation slots opened.

Slider in left position: Ventilation slots closed.

With the ventilation slots open, the stronger air circulation results in a lower air moisture content in the fruit and vegetable compartments.

When the ventilation slots are closed, the natural moisture content of the food in the fruit and vegetable compartments is preserved for longer.

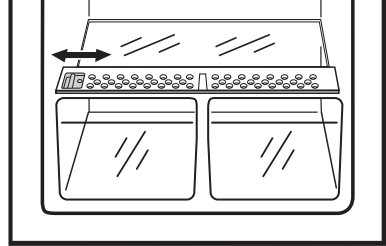

Variable Storage Box

(not on all models, design differs depending on the model)

Some models are equipped with a variable storage box which is fitted under a door shelf compartment and can be slid sideways.

The box can be inserted under every door shelf compartment.

1. To change, lift the shelf compartment with the box upwards and out of the holders in the door and remove the retaining bracket out of the guide under the shelf compartment.
2. Please do the same in reverse to insert the shelf at a different height.

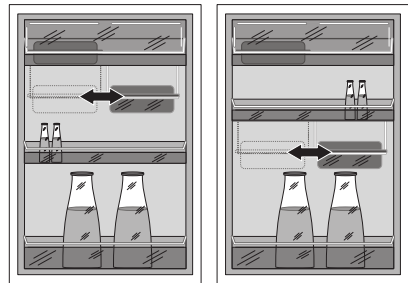

The variable box can be hung from a storage shelf in the refrigerator compartment:

1. Pull the storage shelf forward until it can be tipped up or down and removed.
2. Hang the retaining bracket on the taper on the storage shelf and slide the storage shelf back into the guides.

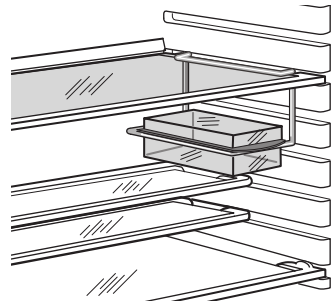

Bottle Holder

Some models are equipped with a bottle holder in the bottle compartment. This is used to prevent individual bottles from falling over and can be slid sideways.

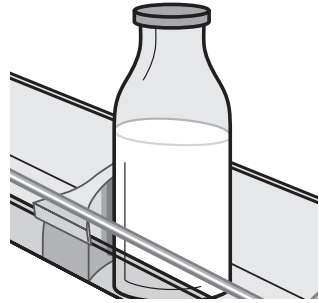

Correct Storage

For physical reasons, there are different temperature regions in the fridge. The coldest region is on the lowest storage shelf. Warmer regions are the top storage shelf, the vegetable drawer and the storage compartments on the door. The arrangement example shows at which places in the refrigerator suitable temperatures for various types of foods exist.

Tip: Food in the fridge should always be covered or packaged, to prevent drying and tainting of other food.

The following are suited for packaging:

- Polyethylene airtight bags and wraps;
- Plastic containers with lids;
- Special plastic covers with elastic;
- Aluminium foil.

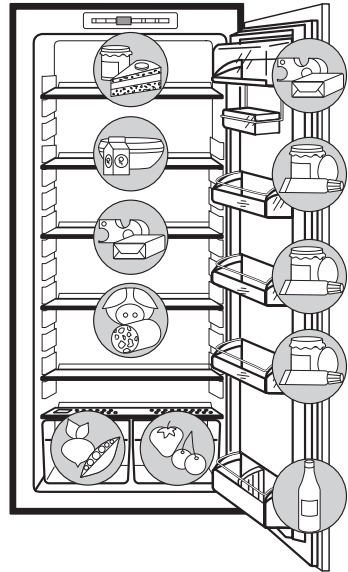

Defrosting

The Fridge Defrosts Automatically

The rear wall of the fridge covers with frost when the compressor is running, and defrosts when the compressor is off. The water from the thawing frost evaporates by itself.

The water drainage hole must be cleaned regularly (see the section "Cleaning and Care").

Cleaning and Care

For hygienic reasons the appliance interior, including interior accessories, should be cleaned regularly.



Warning!

- The appliance may not be connected to the mains during cleaning. Danger of electrical shock! Before cleaning switch the appliance off and remove the plug from the mains, or switch off or turn out the circuit breaker or fuse.
- Never clean the appliance with a steam cleaner. Moisture could accumulate in electrical components, danger of electrical shock! Hot vapours can lead to the damage of plastic parts.
- The appliance must be dry before it is switched back on.

Important!

- Ethereal oils and organic solvents can attack plastic parts, e.g.
 - lemon juice or the juice from orange peel;
 - butyric acid;
 - cleansers which contain acetic acid.

Do not allow such substances to come into contact with appliance parts.

- Do not use any abrasive cleansers.



1. Remove the food from the refrigerator. Store it in a cool place, well covered.
2. Switch the appliance off and remove the plug from the mains, or switch off or turn out the circuit breaker or fuse.
3. Clean the appliance and the interior accessories with a cloth and luke-warm water with a little bicarbonate of soda added (5ml to 0,5 litres of water).

4. After cleaning wipe with fresh water and rub dry.
5. Check the water drain hole on the rear wall of the fridge.
Clear a blocked drain hole with the aid of the green peg in the pack of accessories included with the appliance.
6. After everything is dry switch the appliance back on.

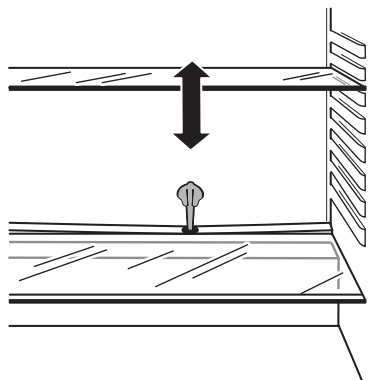

Energy Saving Tips

- Do not install the appliance near cookers, radiators or other sources of warmth. High ambient temperatures cause longer, more frequent operation of the compressor.
- Ensure sufficient air circulation and exhaust at the appliance base and at the back wall of the appliance. Never cover air vent openings.
- Do not place warm foods into the appliance. Allow warm foods to cool first.
- Only leave the door open as long as necessary.
- Do not set temperature any colder than necessary.

What to do if ...

Correcting Malfunctions

A malfunction may be caused by only a minor fault that you can rectify yourself using the following instructions. Do not perform any other work on the appliance if the following information does not provide assistance in your specific case.



Important! Repairs to appliances may only be performed by competent service engineers. Improper repairs can give rise to significant hazards for the user. If your appliance needs repairing, please contact your specialist dealer or your local Service Force Centre.

Symptom	Possible Cause	Remedy
Appliance does not work.	Appliance is not switched on.	Switch on the appliance.
	Mains plug is not plugged in or is loose.	Insert mains plug.
	Fuse has blown or is defective	Check fuse, replace if necessary.
	Socket is defective.	Mains malfunctions are to be corrected by an electrician.
Appliance cools too much.	Temperature is set too cold.	Press „+“ (WARMER) button.
The food is too warm.	Temperature is not properly adjusted.	Please look in the "Starting up and Temperature regulation" section.
	Door was open for an extended period.	Open the door only as long as necessary.
	A large quantity of warm food was placed in the appliance within the last 24 hours.	Turn the temperature regulator to a colder setting temporarily.
	The appliance is near a heat source.	Please look in the "Installation location" section.
Temperature display shows a square.	There is a function fault.	Please inform your local Service Force Centre. Do not open the door of the appliance again.
Interior lighting does not work.	Light bulb is defective.	Please look in the "Changing the light bulb" section.
Heavy build up of frost, possibly also on the door seal.	Door seal is not air tight (possibly after reversing the door).	Carefully warm the leaking sections of the door seal with a hair dryer (on a cool setting). At the same time shape the warmed door seal by hand such that it sits correctly.

Symptom	Possible Cause	Remedy
The compressor does not start immediately after changing the temperature setting.	This is normal, no error has occurred.	The compressor starts after a period of time.
Temperature cannot be set	COOLMATIC function switched on.	Switch off COOLMATIC manually, or wait to set the temperature until the function has reset automatically (refer also to COOLMATIC section).
Water on the floor or on storage shelves.	Water drain hole is blocked.	See the "Cleaning and Care" section.

Changing the Light Bulb



Warning! There is a risk of electric shocks! Before changing the light bulb, switch off the appliance and unplug it, or disconnect from the mains supply.

Light bulb data: 220–240 V, max. 25 W

1. To switch off, press the ON/OFF button until the mains power light goes out.
2. Unplug the mains plug.
3. To change the light bulb, press on the rear hook and at the same time slide the cover in the direction indicated by the arrow.
4. Change the faulty light bulb.
5. Replace the light cover by sliding it into its original position.
6. Switch the refrigerator back on.

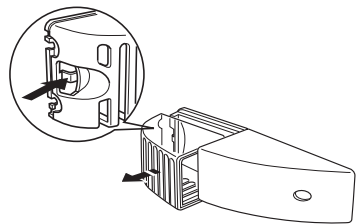

Noises During Operation

The following noises are characteristic of refrigeration appliances:

- **Clicks**

Whenever the compressor switches on or off, a click can be heard.

- **Humming**

As soon as the compressor is in operation, you can hear it humming.

- **Bubbling/Splashing**

When refrigerant flows into thin tubes, you can hear bubbling or splashing noises. Even after the compressor has been switched off, this noise can be heard for a short time.

Regulations, Standards, Guidelines

This appliance was designed for household use and was manufactured in accordance with the appropriate standards. The necessary measures in accordance with appliance safety legislation regulations (GSG), accident prevention regulations for refrigeration appliances (VBG 20) and the regulations of the German Society of Electrical Engineers (VDE) were observed in the manufacture of this appliance.

The refrigerant circuit has been checked for leaks.



This appliance is in accordance with the following EU guidelines:

- 73/23/EWG dated 19 February 1973 - low voltage guidelines.

- 89/336/EWG dated 3 May 1989 (including guideline change notice 92/31/EWG) - EMV guideline

Technical terminology

- **Refrigerant**

Liquids that can be used to generate a cooling effect are known as refrigerants. They have a relatively low boiling-point, indeed so low, that the warmth from the food stored in the fridge or freezer can cause the refrigerant to boil and vaporise.

- **Refrigerant Circuit**

Closed circulation system that contains the refrigerant. The refrigerant circuit comprises primarily of an evaporator, a compressor, a condenser and pipe work.

- **Evaporator**

The refrigerant is evaporated in the evaporator. Similar to all other liquids, refrigerant requires heat to evaporate. This heat is removed from the interior of the appliance, as a result the interior is cooled. The evaporator is therefore located inside the appliance or placed in foam immediately behind the inner wall and thus not visible.

- **Compressor**

The compressor looks like a small drum. It is driven by a built-in electric motor and is mounted on the base of the appliance at the rear. The task of the compressor is to draw in vaporised refrigerant from the evaporator, to compress it, and to pass it on to the condenser.

- **Condenser**

The condenser normally has the form of a grid. The refrigerant compressed in the compressor is liquefied in the condenser. During this process, heat is released to the surrounding air at the surface of the condenser. The condenser is mounted on the base of the appliance.

 **From the Electrolux Group. The world's No.1 choice.**

The Electrolux Group is the world's largest producer of powered appliances for kitchen, cleaning and outdoor use. More than 55 million Electrolux Group products (such as refrigerators, cookers, washing machines, vacuum cleaners, chain saws and lawn mowers) are sold each year to a value of approx. USD 14 billion in more than 150 countries around the world.

AEG Hausgeräte GmbH
Postfach 1036
D-90327 Nürnberg

<http://www.aeg.hausgeraete.de>

© Electrolux plc 2005

2222 634-53 -00- 0405

Subject to change without notice