

SANTO  
Z 91200-4 i

Refrigerator  
Operating Instructions

## Dear customer,

Before **switching on** your new **appliance please** read these operating instructions carefully. They contain important information for safe use, for installation and for care of the appliance.

Please keep these operating instructions for future reference. Pass them on to possible new owners of the appliance.

These operating instructions are for use with several technically comparable models with varying accessories. Please observe the notes which apply to your model.



Notes which are important for your safety or for the proper functioning of the appliance are stressed with a warning triangle and/or with signal words (**Warning!**, **Caution!**, **Important!**). Please observe the following carefully.



1. This symbol guides you step by step in the operation of the appliance.
2. ....



Supplementary information regarding operation and practical applications of the appliance appear after this symbol.



Tips and notes concerning economical and environmentally sound use of the appliance are marked with the cloverleaf.

The operating instructions contain instructions for the correction of possible malfunctions by the user in the section "What to do if ...". If these instructions should not be sufficient, contact your local Service Force Centre.

Printed on paper manufactured with environmentally sound processes  
he who thinks ecologically acts accordingly...

# Contents

Important Safety Instructions .....	4
Disposal .....	6
Appliance Packaging Information / Disposal of Old Appliances .....	6
Remove Transport Packaging .....	7
Installation .....	7
Installation Location .....	7
Your Refrigerator Needs Air / Installation .....	8
Power Supply .....	9
Electrical Connection .....	10
Description of the Appliance .....	11
View of the Appliance .....	11
Control Panel / Temperature Setting Buttons .....	12
Temperature Display / Warning System / Air Filter .....	13
Prior to Initial Start-Up .....	15
Starting Up and Temperature Regulation .....	15
TURBO COOLMATIC .....	16
Switching Off the Appliance .....	16
Interior Accessories .....	17
Storage Shelves .....	17
Variable Inner Door / Bottle Holder .....	18
LONGFRESH 0°C compartment .....	18
Humidity Control .....	19
Drawers .....	19
Correct Storage .....	20
Defrosting .....	23
The Fridge Defrosts Automatically .....	23
Cleaning and Care .....	23
Energy Saving Tips .....	24
What to do if ... ..	25
Correcting Malfunctions .....	25
Changing the Light Bulb .....	26
Noises During Operation .....	26
Regulations, Standards, Guidelines .....	27
Technical Terminology .....	27



## Important Safety Instructions

These warnings are provided in the interest of your safety. Ensure you fully understand them before installing or using the appliance. Your safety is of paramount importance. If you are unsure about the meaning of these warnings contact the Customer Care Department for assistance.

### Intended use

- The refrigerator is intended for use in the home. It is suitable for the storing of food at low temperature. If the appliance is used for purposes other than those intended or used incorrectly, no liability can be accepted by the manufacturer for any damage that may be caused.
- Alterations or changes to the refrigerator are not permitted for reasons of safety.
- If you use the refrigerator in a commercial **environment** or for purposes other than the cooling of foods, the manufacturer accepts no liability for any damages which may occur.

### Prior to initial start-up

- Ensure that the appliance does not stand on the electrical supply cable. **Important:** if the supply cable is damaged, it must be replaced by a cable available from the manufacturer or your local Service Force Centre.
- Check the appliance for transport damage. Under no circumstance should a damaged appliance be plugged in. In the event of damage, please contact your supplier.

### Refrigerant

The refrigerant isobutane (R600a) is contained within the refrigerant circuit of the appliance, a natural gas with a high level of environmental compatibility, which is nevertheless flammable.

- **Warning** - During transportation and installation of the appliance, be certain that none of the components of the refrigerant circuit become damaged.
- If the refrigerant circuit should become damaged:
  - avoid open flames and sources of ignition;
  - thoroughly ventilate the room in which the appliance is situated.

### Safety of children

- Packaging (e.g. wraps, polystyrene) can be dangerous for children. There is a risk of suffocation! Keep packaging material away from children!
- Please make old appliances unusable prior to disposal. Pull out the mains plug, cut off the mains cable, break or remove spring or bolt catches, if fitted. By doing this you ensure that children cannot lock themselves in the appliance when playing (there is risk of suffocation!) or get themselves into other dangerous situations.
- Often children cannot recognise the hazards present in household appliances. It is therefore important that you ensure adequate supervision and never let children play with the appliance!

### Daily Operation

- Containers with flammable gases or liquids can leak at low temperatures. There is a risk of an explosion! Do not store any containers with flammable materials such as spray cans, fire extinguisher refill cartridges etc in the refrigerator and/or freezer.
- **Warning** - Do not operate any electrical appliances in the refrigerator and/or freezer (e.g. electric ice cream makers, mixers etc.).
- **Warning** - In order not to impair the function of the appliance, never cover or obstruct the ventilation openings.
- **Warning** - Do not damage the cooling circuit.
- Before cleaning the appliance, always switch off the appliance and unplug it, or pull the house fuse or switch off the circuit breaker.
- When unplugging always pull the plug from the mains socket, do not pull on the cable.

### In case of malfunction

- If a malfunction occurs on the appliance, please look first in the "What to do if ..." section of these instructions. If the information given there does not help, please do not perform any further repairs yourself.
- Under no circumstance should you attempt to repair the appliance yourself. Repairs carried out by inexperienced persons may cause injury or serious malfunctioning. Contact your local Service Force Centre.

# Disposal

## Appliance Packaging Information

All materials are environmentally sound! They can be disposed of or burned at an incinerating plant without danger.

About the materials: The plastics can be recycled and are identified as follows:

>PE< for polyethylene, e.g. the outer covering and the bags in the interior.

>PS< for polystyrene foam, e.g. the pads, which are all free of chloro-fluorocarbon.

The carton parts are made from recycled paper and should be disposed of at a waste-paper recycling collection location.

## Disposal of Old Appliances

For environmental reasons, refrigeration appliances must be disposed of properly. This applies to your old appliance, and - at the end of its service life - for your new appliance as well.



**Warning!** Before disposing of old appliances make them inoperable. Remove plug from mains, sever the power cable, remove or destroy any snap or latch closures. This ensures **that children** do not lock themselves inside the appliance (danger of suffocation!) or place themselves into other life-endangering situations.

### Disposal:

- The appliance may not be disposed of with domestic waste or bulky refuse.
- The refrigerant circuit, especially the heat exchanger at the back of the appliance, must not be damaged.
- The symbol  on the product or on its packaging indicates that this product may not be treated as household waste. Instead it shall be handed over to the applicable collection point for the recycling of electrical and electronic equipment. By ensuring this product is disposed of correctly, you will help prevent potential negative consequences for the environment and human health, which could otherwise be caused by inappropriate waste handling of this product. For more detailed information about recycling of this product, please contact your local city office, your household waste disposal service or the shop where you purchased the product.

# Remove Transport Packaging

The appliance and the interior fittings are protected for transport.

-  1. Pull off the adhesive tape on the left and right side of the door.
2. Remove all adhesive tape and packing pieces from the interior of the appliance.

## Installation

### Installation Location

The appliance should be set up in a well ventilated, dry room.

Energy use and efficient performance of the appliance is affected by the ambient temperature.

The appliance should therefore

- not be exposed to direct sunlight;
- not be installed next to radiators or other sources of heat;
- only be installed at a location whose ambient temperature corresponds to the climate classification, for which the appliance is designed.

The climate classification can be found on the serial plate, which is located at the left on the inside of the appliance.

The following table shows which ambient temperature is correct for each climate classification:

Climate classification	for an ambient temperature of
SN	+10 to +32 °C
N	+16 to +32 °C
ST	+18 to +38 °C
T	+18 to +43 °C

Installation directly under a hob is not allowed. The temperatures of the hob, which in part are quite high, may damage the appliance.

If a hob is installed near the appliance, the corresponding installation and safety instructions must be adhered to. Considering the numerous installation conditions which are possible, there is no way of providing detailed information here.

It is necessary to avoid overheating of the refrigerator by maintaining adequate distances from heat sources and by the use of a suitable thermal insulation plate. Proper ventilation of the appliance must also be ensured.

## Your Refrigerator Needs Air

### Integratable models (i-appliances)

The integrated door of the furniture cabinet largely seals the installation recess. i-appliances must therefore be provided with ventilation by having an opening in the furniture plinth. The warmed air must be able to be exhausted upwards through the air shaft on the furniture back. The ventilation cross-sections should be at least 200 cm<sup>2</sup>.

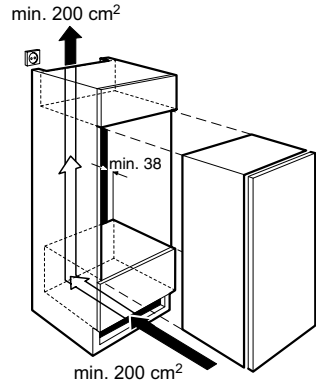

**Warning** - To ensure the appliance functions correctly, never cover or obstruct the ventilation openings.

## Installation

### Dimensioned drawing

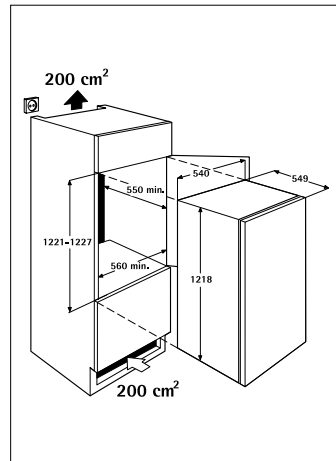

See installation instructions supplied.  
Please check whether, after installing your appliance and especially after reversing the door, the door seal seals right round. A badly fitting door seal may lead to heavy frosting and thereby to a higher power consumption (see also „What to do if...“).



## Power Supply

A correctly installed, earthed socket is required for the electrical supply. The supply must have a fuse rating of at least 10 Amps. If the socket is not accessible once the appliance is built in, the electrical installation must include suitable means of isolating the appliance from the mains (e.g. a fused spur).



Before initial start-up, refer to the appliance rating plate to ascertain if supply voltage and current values correspond with those of the mains at the installation location.

e.g.: AC 220 ... 240 V 50 Hz or  
220 ... 240 V ~50 Hz

(i.e. 220 to 240 volts alternating current, 50 Hertz)

The rating plate is inside the appliance on the left.

The mains cable may only be changed by a qualified electrician or competent person. If your appliance needs repairing, please contact your local Customer Care Department.

## Electrical Connection

Any electrical work required to install this appliance should be carried out by a qualified electrician or competent person.



### WARNING – THIS APPLIANCE MUST BE EARTHED

The manufacturer declines any liability should these safety measures not be observed.

Before switching on, make sure the electricity supply voltage is the same as that indicated on the appliance rating plate. The rating plate is inside, on the left.

The appliance is supplied with a 13 amp plug fitted. In the event of having to change the fuse in the plug supplied, a 13 amp ASTA approved (BS 1362) fuse must be used.

### Important

The wires in the mains lead are coloured in accordance with the following code:

Green and Yellow: Earth  
Blue: Neutral  
Brown: Live

As the colours of the wires in the mains lead of this appliance may not correspond with the coloured markings identifying the terminals in your plug, proceed as follows:

1. The wire coloured green and yellow must be connected to the terminal marked with the letter "E" or by the earth symbol or coloured green and yellow.
2. The wire coloured blue must be connected to the terminal "N" or coloured black.
3. The wire coloured brown must be connected to the terminal marked "L" or coloured red.
4. Upon completion there must be no cut, or stray strands of wire present and the cord clamp must be secure over the outer sheath.

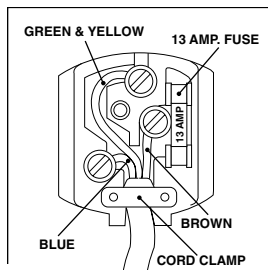

**Warning!** A cut-off plug inserted into a 13 amp socket is a serious safety (shock) hazard. Ensure that the cut-off plug is disposed of safely.

# Description of the Appliance

## View of the Appliance

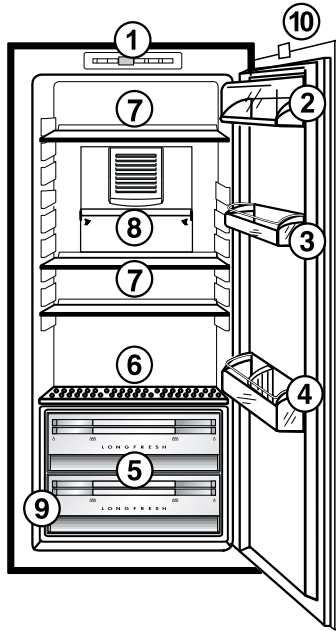

- 1 = Control panel
- 2 = Butter/cheese compartment with flap
- 3 = Door storage compartment
- 4 = Bottle shelf
- 5 = LONGFRESH 0°C compartment with humidity control
- 6 = Storage shelf (suitable for cans and bottles)
- 7 = Storage shelves
- 8 = Air filter
- 9 = Rating plate
- 10 = Magnet holder for interior lighting and door alarm

## Control Panel

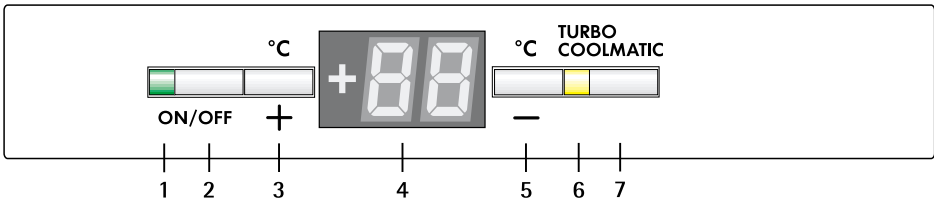

- 1 Pilot light (green)
- 2 ON/OFF switch
- 3 Temperature setting buttons (for warmer temperatures)
- 4 Temperature display
- 5 Temperature setting buttons (for colder temperatures)
- 6 FROSTMATIC indicator light (yellow)
- 7 Push button for FROSTMATIC
- 8 **TURBO COOLMATIC** indicator light (yellow)
- 9 Push button for **TURBO COOLMATIC**

## Temperature Setting Buttons

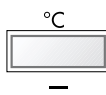
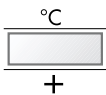

The temperature is adjusted using the "+" (WARMER) and "-" (COLDER) buttons.

These buttons are connected to the temperature display.

- The temperature display is switched over from the display of the ACTUAL temperature (temperature display is illuminated) to the display of the DESIRED temperature (temperature display flashes) by pressing one of the two buttons, "+" or "-".
- With each further press of one of the two buttons, the DESIRED temperature is adjusted by 1°C.
- If neither button is pressed, the temperature display automatically switches back after a short period (approx. 5 sec.) to the display of the ACTUAL temperature.

DESIRED temperature means:

The temperature that is required in the refrigerator, this can be adjusted to the temperatures shown in the display. The DESIRED temperature is indicated by flashing numbers.

ACTUAL temperature means:

The temperature display indicates the temperature that is currently present in the refrigerator. The ACTUAL temperature is indicated by continuously illuminated numbers.

## Temperature Display



The temperature display can indicate several pieces of information.

- During normal operation, the temperature currently present in the refrigerator (ACTUAL temperature) is displayed.
- When the temperature is being adjusted, the temperature currently set flashes (DESIRED temperature).
- If the electronics in the appliance have detected a fault that prevents the ACTUAL temperature being measured, the temperature display shows a square. The appliance will continue to function using a backup programme until your local Service Force has repaired the appliance.

## Warning System

The warning system comprises of an acoustic warning tone. The warning tone sounds if the door is left open for more than 3 minutes.

You can switch off the warning tone by closing the door.

## Air Filter

Your appliance is equipped with a charcoal filter "AIR FILTER" in the rear wall of the fridge compartment.

The filter purifies the air from unwanted odours in the fridge and LONGFRESH compartment meaning that the storage quality will be further improved.



**Note:** Always keep the air ventilation flap closed.

The charcoal filter is a consumable accessory and as such is not covered by the guarantee.

### Installation of the charcoal filter

On delivery the charcoal filter is placed in a plastic bag to secure the length of life of the charcoal filter. The filter should be placed behind the flap before the appliance is turned on.

- 1. Pull the cover outward (1).

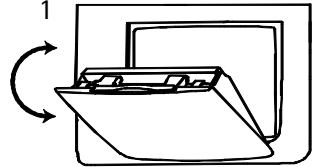

- 2. The charcoal filter is then mounted in the slot found in the back of the cover (2).
- 3. Close the flap.

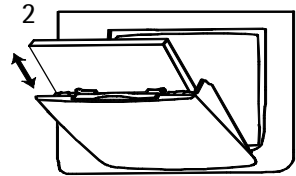

#### Important!

During operation, always keep the air ventilation flap closed.

The filter should be handled carefully so fragments do not loosen from the surface.

### Changing the charcoal filter

To maintain the best performance the carbon filter should be changed every year.

New charcoal filters can be purchased from your local dealer.

- 1. The filter is placed behind the cover and can be reached by pulling the cover outward (1).

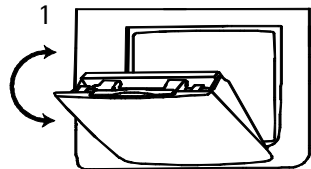

- 2. The charcoal filter is then pulled out of its slot.
- 3. The new charcoal filter is placed in the existing slot (2). Close the flap.

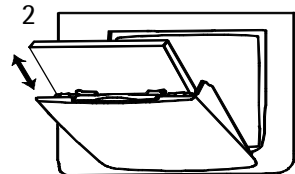

## Prior to Initial Start-Up

-  Please clean the appliance interior and all accessories prior to initial start-up (see section: "Cleaning and Care").

### Standby time

The oil for automatic lubrication contained in the compressor may flow into the refrigeration circuit if the appliance is transported in an inclined position. To allow the oil to flow back into the compressor, wait approximately 1 hour before placing the appliance in operation.

## Starting Up and Temperature Regulation

-  1. Insert the plug into the plug socket. When the refrigerator compartment door is opened, the internal lighting is switched on.
- 2. Press ON/OFF button.  
The green mains pilot indicator and the temperature display illuminate.
- 3. Press either the "+" (WARMER) or "-" (COLDER) button.  
The temperature display switches over and the DESIRED temperature currently set flashes on the temperature display.
- 4. Set the required temperature by pressing the "+" (WARMER) or "-" (COLDER) buttons (see section "Temperature setting buttons"). The temperature display will immediately show the changed setting. With each further press of one of the two buttons, the DESIRED temperature is adjusted by 1°C.

Adjustable temperature range: +3°C to +8°C.

-  **Note:** From a food safety point of view, +5°C for the refrigerator compartment should be considered cold enough as a storage temperature.
- 5. Once the required temperature has been set, after a short period (approx. 5 sec.) the temperature display will change and again indicate the current ACTUAL temperature inside the fridge. The display will change from flashing to continuous illumination.

The compressor will start and then run automatically.

**Information!** When the setting is changed, the compressor does not start immediately if automatic defrosting is currently taking place.

-  Goods to be refrigerated can be loaded immediately after switching on, because the storage temperature in the refrigerator is quickly reached.



In the LONGFRESH 0°C compartment the temperature is controlled automatically. It stays constantly at about 0°C, no adjustment is necessary.

**Note:** The refrigerator compartment is fitted with a fan. This quickly cools food stuffs and ensures optimal distribution of the temperature between the fridge and the LONGFRESH 0°C compartment. This results in the fan operating at different speeds for different lengths of time. This is quite normal and not a fault with the appliance.

## TURBO COOLMATIC

### TURBO COOLMATIC Button

**TURBO  
COOLMATIC**



The TURBO COOLMATIC function is suited for quick cooling of large quantities of goods in the refrigerator, e.g. drinks and salads for a party.

1. The TURBO COOLMATIC function is switched on by pressing the TURBO COOLMATIC button. The yellow light illuminates.
2. The TURBO COOLMATIC function now ensures intensive cooling. A DESIRED temperature of +3°C is automatically selected. The TURBO COOLMATIC function is ended automatically after a period of 6 hours. The originally selected DESIRED temperature is again valid and the compartment will return to. The temperature display shows the ACTUAL refrigerator temperature.
3. The TURBO COOLMATIC function can be ended manually at any time by pressing the TURBO COOLMATIC button again. The yellow light goes out.

## Switching Off the Appliance

- To switch off, press the ON/OFF button for approx. 5 seconds. This will result in a countdown from "3" to "1" taking place in the temperature display. On reaching "1" the fridge will switch off. The temperature display will go off.

**Note:** The appliance cannot be switched on or off if unplugged, or if there is no power being supplied to it. Following connection to the



mains power supply, the appliance returns to the same operating state as before the interruption of main power.

**If the appliance is not going to be used for an extended period:**

1. Remove all refrigerated packages.
2. Switch off the appliance by holding down the ON/OFF button until the display goes off (see above).
3. Remove the mains plug or switch off or disconnect from the electricity supply.
4. Clean thoroughly (see section "Cleaning and Care").
5. Leave the doors open to avoid the build up of odours.

## Interior Accessories

### Storage Shelves

On the bottom of the refrigerator compartment, just above the LONGFRESH 0°C compartment, you can easily place cans and bottles in horizontal position. The structure of this area will prevent the bottles and cans from moving around.

The height of the storage shelves can be adjusted:

1. To do this pull the storage shelf forward until it can be swivelled upwards or downwards and removed.
2. Please do the same in reverse to insert the shelf at a different height.

Your appliance is equipped with two half-size glass storage shelves.

Storing tall items:

1. Slide the front half of the Vario storage shelf in another level to the rear. By this means you will gain space to place tall items on the storage shelf below.

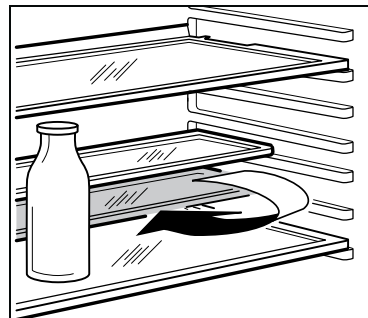
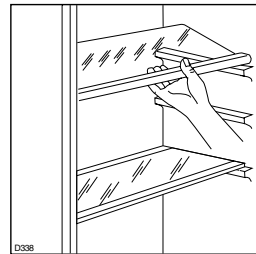

## Variable Inner Door

The door compartments can be pulled up and removed, and inserted at other positions as needed.

## Bottle Holder

Your model is equipped with a bottle holder in the bottle compartment. This is used to prevent individual bottles from falling over and can be slid sideways.

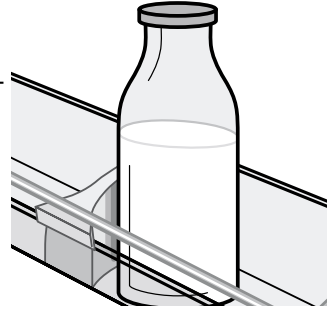

## LONGFRESH 0°C Compartment

In the LONGFRESH 0°C compartment the temperature is controlled automatically. It stays constantly at about 0°C, no adjustment is necessary.

The constant storage temperature of about 0°C and the relative humidity of between 45 and 90 % provide optimal conditions for the various kinds of food.

**i** You can therefore store a variety of fresh food in the LONGFRESH 0°C compartment, where it will last up to 3 times longer with better quality compared to normal refrigerator compartments.

This allows you to stock more fresh food. Taste, degree of freshness, quality and nutritional values (vitamins and minerals) are well preserved. Loss of weight in vegetables and fruit diminishes. Food yields a higher degree of nutritional value.

**i** The LONGFRESH 0°C compartment is also suitable for defrosting food. In this case the thawed food can be stored up to two days in the LONGFRESH 0°C compartment.

## Humidity Control

Both drawers can be used according to the desired storage conditions independently of each other with lower or higher humidity.

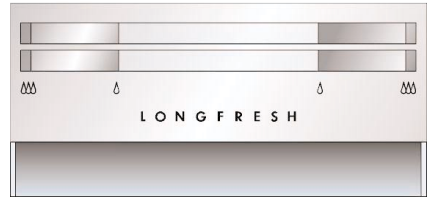

Regulation for each drawer is separate and is controlled using the slide valve at the front of the drawer.

- **“Dry”**: low air humidity - up to 50 % relative humidity

This humidity level is reached when both sliders are set into this position Δ and the ventilation openings are wide open.

- **“Humid”**: high relative humidity - up to 90%

This humidity level is reached when both sliders are set in this position ∩ and the ventilation openings are closed. Humidity is kept and can not escape.

## Drawers



The wire shelves inside the drawers permit that air can circulate freely and consequently a better conservation of foods.

The top drawer is equipped with a removable divider. Depending on the individual need the divider can be placed in different positions. Thereby various food can be stored clear and separated. Storage conditions are equal in both sections. It is not possible by using the divider to split up the basket in a dry and humid compartment.



The design of the upper drawer permits you to clean it, by removing the divider.

The compartment has stops to prevent the drawers from falling out when fully extended.

To remove the drawers (e.g. for cleaning purposes), pull them out as far as the stops, lift and extract.

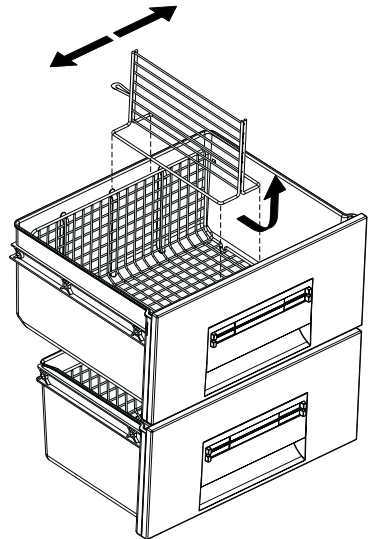

# Correct Storage

The refrigerator compartment is fitted with a fan. This quickly cools food stuffs and ensures optimal distribution of the temperature between the fridge and the LONGFRESH 0°C compartment.

The following can be conserved in the refrigeration compartment:

- beverages, preserves, jars, bottles;
- baked goods, prepared foods;
- products with short-term expiration;
- foods which are not suitable for conservation at the temperature of the LONGFRESH 0°C compartment.

## Tips:



- Do not place warm foods or uncovered liquids in the refrigerator.
- Place foods in such a way that air can circulate freely.
- Keep butter and cheese in the special compartment to guarantee their consistency and aroma.
- Foods, especially salad, must be kept well covered or packaged in such a way that they do not dry out and that their flavours and fragrances remain unchanged.





The following are suited for packaging:

- Polyethylene airtight bags and wraps;
- Plastic containers with lids;
- Special plastic covers with elastic;
- aluminium foil.
- High-proof spirits should only be conserved tightly closed and in a vertical position.
- Do not keep explosive or flammable materials in the refrigerator.

Conserve in the LONGFRESH 0°C compartment all foods which are suited to it.



## Storage time in the LONGFRESH 0°C compartment for fresh food

Type of food	Air humidity adjustment	Storage time
Onion	 "dry"	up to 5 months
Butter	 "dry"	up to 1 month
Large pork cuts	 "dry"	up to 10 days

Type of food	Air humidity adjustment	Storage time
Beef, venison, small pork cuts, poultry	 "dry"	up to 7 days
Tomato sauce	 "dry"	up to 4 days
Fish, shellfish, cooked meat products	 "dry"	up to 3 days
Cooked seafood	 "dry"	up to 2 days
<b>Salad, vegetables</b> Carrots, herbs, Brussels sprouts, celery	 "humid"	up to 1 month
Artichokes, cauliflower, chicory, iceberg lettuce, endive, lamb's lettuce, lettuce, leeks, radicchio	 "humid"	up to 21 days
Broccoli, Chinese leaves, kale, cabbage, radishes, Savoy cabbage	 "humid"	up to 14 days
Peas, kohlrabi	 "humid"	up to 10 days
Spring onions, asparagus, spinach	 "humid"	up to 7 days
<b>Fruit (*)</b> Pears, dates (fresh), strawberries, peaches (*)	 "humid"	up to 1 month
Plums (*), rhubarb, gooseberries	 "humid"	up to 21 days
Apples (not sensitive to cold), quinces	 "humid"	up to 20 days
Apricots, cherries	 "humid"	up to 14 days
Damsons, grapes	 "humid"	up to 10 days

(\*) The riper the fruit, the shorter the storage time

## Correct Storage

Type of food	Air humidity adjustment	Storage time
Blackberries, currants	 "humid"	up to 8 days
Figs (fresh)	 "humid"	up to 7 days
Blueberries, raspberries	 "humid"	up to 5 days



Cakes containing cream and other kinds of pastry products can be stored in the LONGFRESH 0°C compartment for 2 or 3 days.

### Important!

Not to be placed in the LONGFRESH 0°C compartment:

- cold sensitive fruit which have to be stored at cellar or room temperature like pineapple, bananas, grapefruit, melons, mango, papaya, oranges, lemons, kiwi fruit.
- The types of food not mentioned above should be stored in the refrigerator compartment (e.g. all sorts of cheese, cold cuts, etc.).



The level of air humidity in the drawers depends on the content of humidity in the stored food, vegetable and fruit and on the frequency of door opening



The LONGFRESH 0°C compartment is also suitable for slow thawing of food. In this case the thawed food can be stored in the LONGFRESH 0°C compartment for up to two days.

### Tips:

- Pay attention to the freshness of the food, especially on the expiry date. Quality and freshness influence the storage time.
- The whole storage cycle time will depend on the preservation conditions made prior to the final storage in the fridge.
- Food, fruit or vegetables should always be packed or wrapped up before storage.
- Animal food always store packed and dry.
- Food rich in proteins will go bad quicker. This means seafood will spoil before fish which in turn will spoil before meat. While storing food in a 0°C compartment storage time for that kind of food can be increased by up to three times as well without loss on quality.
- All food stored in a 0°C compartment should be taken out of the drawers roughly 15-30 min before consumption, particularly fruit and vegetables to be consumed without any additional cooking

process. Allowing fruit and vegetables to return to room temperature will improve the texture and flavour.

## Defrosting

### The Fridge Defrosts Automatically

Defrosting of the **fridge** compartment is **automatic**.

During defrosting, the air re-circulation fan is off.

The water that forms flows into a dish on the compressor and evaporates. This dish cannot be removed.

## Cleaning and Care

For hygienic reasons the appliance interior, including interior accessories, should be cleaned regularly.



### Warning!

- The appliance **must** not be connected to the mains during cleaning. Danger of electrical shock! Before cleaning switch the appliance off and remove the plug from the mains, or switch off or turn out the circuit breaker or fuse.
- Never clean the appliance with a steam cleaner. Moisture could accumulate in electrical components, danger of electrical shock! Hot vapours can lead to the damage of plastic parts.
- The appliance must be dry before it is **switched back on**.

### Important!

- Ethereal oils and organic solvents can attack plastic parts, e.g.
  - lemon juice or the juice from orange peel;
  - butyric acid;
  - cleansers which contain acetic acid.

Do not allow such substances to come into contact with appliance parts.

- Do not use any abrasive cleansers.

1. Remove the food from the refrigerator. Store it in a cool place, well covered.

2. Switch the appliance off and remove the plug from the mains, or switch off or turn out the circuit breaker or fuse.
3. Clean the appliance and the interior accessories with a cloth and luke-warm water with a little bicarbonate of soda added (5ml to 0,5 litres of water).
4. After cleaning wipe with **clean** water and rub dry.
5. After everything is dry **switch the appliance back on**.



The lowest shelf, dividing the cooler compartment from the LONGFRESH 0°C compartment can be removed for cleaning. To remove pull out the shelf straight.

The cover plates above the drawers in the 0°C compartment can be taken out for cleaning. To make sure fully functionality of the LONGFRESH 0°C compartment the cover must be put back in their original position after cleaning.



## Energy Saving Tips

- Do not install the appliance near cookers, radiators or other sources of warmth. High ambient temperatures cause longer, more frequent operation of the compressor.
- Ensure sufficient air circulation and exhaust at the appliance base and at the back wall of the appliance. Never cover air vent openings.
- Do not place warm foods into the appliance. Allow warm foods to cool first.
- Only leave **the** door open as long as necessary.
- Do not set temperature any colder than necessary.



# What to do if ...

## Correcting Malfunctions

A malfunction may be caused by only a minor fault that you can rectify yourself using the following instructions. Do not perform any other work on the appliance if the following information does not provide assistance in your specific case.



**Important!** Repairs to refrigerators/freezers may only be performed by competent service engineers. Improper repairs can give rise to significant hazards for the user. If your appliance needs repairing, please contact your specialist dealer or your local Service Force Centre.

Symptom	Possible Cause	Remedy
Appliance does not work.	Appliance is not switched on.	Switch on the appliance.
	Mains plug is not plugged in or is loose.	Insert mains plug.
	Fuse has blown or is defective	Check fuse, replace if necessary.
	Socket is defective.	Mains malfunctions are to be corrected by an electrician.
Appliance cools too much.	Temperature is set too cold.	Press „+“ (WARMER) button.
The refrigerator and/or freezer compartment temperature is insufficient.	Temperature is not properly adjusted.	Please look in the "Starting up and Temperatur regulation" section.
	Door was open for an extended period.	Open the door only as long as necessary.
	A large quantity of warm food was placed in the appliance within the last 24 hours.	Press <b>TURBO COOLMATIC</b> button.
	The appliance is near a heat source.	Please look in the "Installation location" section.
Interior lighting does not work.	Light bulb is defective.	Please look in the "Changing the light bulb" section.
The compressor does not start immediately after pressing the <b>TURBO COOLMATIC</b> button, or after changing the temperature setting.	This is normal, no error has occurred.	The compressor starts after a period of time.

## Changing the Light Bulb



**Warning!** There is a risk of electric shocks! Before changing the light bulb, switch off the appliance and unplug it, or disconnect from the mains supply.

Light bulb data: 220–240 V, max. 25 W

1. To switch off, press the ON/OFF button until the mains power light goes out.
2. Unplug the mains plug.
3. To change the light bulb, press on the rear hook and at the same time slide the cover in the direction indicated by the arrow.
4. Change the faulty light bulb.
5. Replace the light cover by sliding it into its original position.
6. Switch the refrigerator back on.

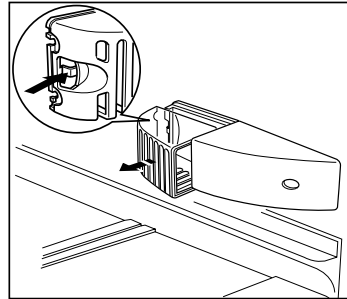

## Noises During Operation

The following noises are characteristic of refrigeration appliances:

- **Clicks**

Whenever the compressor switches on or off, a click can be heard.

- **Humming**

As soon as the compressor is in operation, you can hear it humming.

- **Bubbling/Splashing**

When refrigerant flows into thin tubes, you can hear bubbling or splashing noises. Even after the compressor has been switched off, this noise can be heard for a short time.

- **Rustling**

Your appliance is equipped with a dynamic air ventilation system. To ensure optimal cooling performance in the refrigerator and LONGFRESH 0°C compartment the fan is operates with various power levels. This results in the fan operating at different speeds for different lengths of time. This is quite normal and not a fault with the appliance.

# Regulations, Standards, Guidelines

This appliance was designed for household use and was manufactured in accordance with the appropriate standards. The necessary measures in accordance with appliance safety legislation regulations (GSG), accident prevention regulations for refrigeration appliances (VBG 20) and the regulations of the German Society of Electrical Engineers (VDE) were observed in the manufacture of this appliance.

The refrigerant circuit has been checked for leaks.



This appliance is in accordance with the following EU guidelines:

- 73/23/EWG dated 19 February 1973 - low voltage guidelines.
- 89/336/EWG dated 3 May 1989 (including guideline change notice 92/31/EWG) - EMV guideline

## Technical terminology

- **Refrigerant**

Liquids that can be used to generate a cooling effect are known as refrigerants. They have a relatively low boiling-point, indeed so low, that the warmth from the food stored in the fridge or freezer can cause the refrigerant to boil and vaporise.

- **Refrigerant Circuit**

Closed circulation system that contains the refrigerant. The refrigerant circuit comprises primarily of an evaporator, a compressor, a condenser and pipe work.

- **Evaporator**

The refrigerant is evaporated in the evaporator. Similar to all other liquids, refrigerant requires heat to evaporate. This heat is removed from the interior of the appliance, as a result the interior is cooled. The evaporator is therefore located inside the appliance or placed in foam immediately behind the inner wall and thus not visible.

- **Compressor**

The compressor looks like a small drum. It is driven by a built-in electric motor and is mounted on the base of the appliance at the rear. The task of the compressor is to draw in vaporised refrigerant from the evaporator, to compress it, and to pass it on to the condenser.

- **Condenser**

The condenser normally has the form of a grid. The refrigerant compressed in the compressor is liquefied in the condenser. During this process, heat is released to the surrounding air at the surface of the condenser. The condenser is mounted on the base of the appliance.

 **From the Electrolux Group.** The world's No.1 choice.

*The Electrolux Group is the world's largest producer of powered appliances for kitchen, cleaning and outdoor use. More than 55 million Electrolux Group products (such as refrigerators, cookers, washing machines, vacuum cleaners, chain saws and lawn mowers) are sold each year to a value of approx. USD 14 billion in more than 150 countries around the world.*

AEG Hausgeräte GmbH  
Postfach 1036  
D-90327 Nürnberg

<http://www.aeg.hausgeraete.de>

© Electrolux plc 2005

2222 722-81 -00- 0306

Subject to change without notice