

# JLBIGGH 704

## Electronic gas hob

### Instruction manual

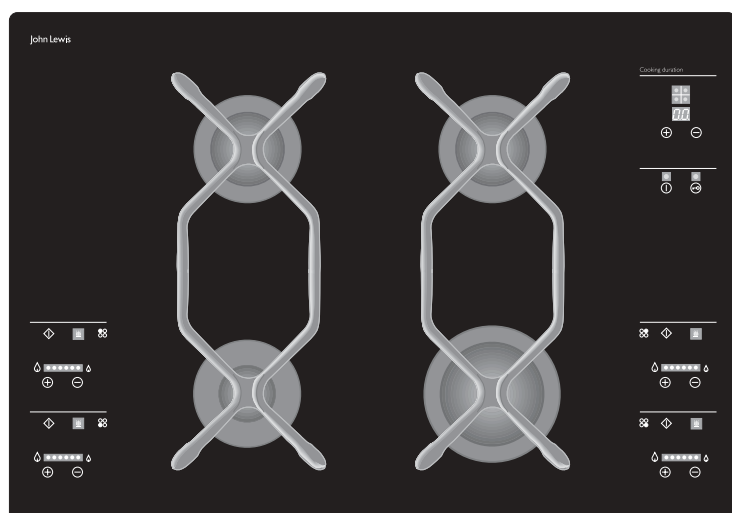

# John Lewis

GB

IE

# Important Safety Information



It is most important that this instruction manual should be retained with the appliance for future reference. Should the appliance be sold or transferred to another owner, or should you move house and leave the appliance, always ensure that the book is supplied with the appliance in order that the new owner can get to know the functioning of the appliance and the relevant warnings. These warnings have been provided in the interest of safety.

You **MUST** read them carefully before use or installation by a qualified person. If you are unsure of the meanings of these warnings contact the John Lewis branch from which you purchased the appliance.

## Installation

- This appliance must be installed and serviced by a competent person as stated in the Gas Safety (Installation and Use) Regulations Current Editions and the IEE Wiring Regulations.
- For appliances installed in the Republic of Ireland please refer to NSAI-Domestic Gas Installations I.S.813 Current Editions and the ETCI Rules for Electrical Installations.
- Installation of the appliance and connection to the power supply must only be carried out by **QUALIFIED PERSONNEL**. Before any intervention, make sure the appliance is **DISCONNECTED** from the power supply.
- Ensure that air can freely circulate around the appliance. Poor ventilation produces a lack of oxygen.
- Ensure that the gas and electrical supply complies with the type stated on the rating plate, located below the front edge of the glass top.
- This appliance is not connected to a combustion products evacuation device. It must be installed and connected in accordance with current installation regulations. Particular attention shall be given to the relevant regulations regarding ventilation.
- When in use a gas cooking appliance will produce heat and moisture in the room in which it has been installed. Ensure there is a continuous air supply, keeping air vents in good condition or installing a cooker hood with a venting hose.
- When using the hob for a long period time, the ventilation should be improved, by opening a window or increasing the extractor speed.
- After unpacking the appliance, make sure the product is not damaged and that the power cable is in perfect condition. Otherwise, contact the dealer before installing the appliance.
- The manufacturer declines any liability should these safety measures not be observed.

## Child Safety

- Keep packaging away from children.
- This hob is designed to be operated by adults. Do not allow children to play near or with the hob. It is highly recommended to activate the child safety function every time the hob is not operated.
- The hob gets hot during use and some time after it is switched off. The hob is supplied with special indicators for the residual heat (see chapter “How to light a burner”). Children should be kept away from the appliance until it has cooled down and the residual heat indicators are off.

## Use

- This hob is intended for domestic cooking only. It is not designed for commercial or industrial purposes.
- It is dangerous to modify or try to modify the characteristics of this product.
- Keep the appliance clean. Food residuals increase the risk of fire.
- This appliance cannot be cleaned with steam or with a steam cleaning machine.
- In case of malfunctions, never attempt to repair the appliance on your own. Repairs carried out by unqualified persons can cause damage and accidents. Refer to the contents of this booklet (see chapter “Something not working”). If you do not find the information required, contact the nearest Service Force Centre. Servicing of this appliance must be carried out by an authorised Service Engineer. Always insist on genuine spare parts.
- After using the appliance, deactivate it by using the main ON/OFF touch control and make sure the relevant red indicator is off. Then, lock all the hob controls by touching the “Key” Control .
- When using other electrical appliances, ensure the cable does not come into contact with the hot surfaces of this cooking appliance.

## Service

- This hob should only be repaired or serviced by an authorised Service Engineer and only genuine approved spare parts should be used.



## Environmental Information

- After installation, please dispose of the packaging with due regard to safety and the environment.
- When disposing of an old appliance, make it unusable, by cutting off the cable.



- The symbol  on the product or on its packaging indicates that this product may not be treated as household waste. Instead it shall be handed over to the applicable collection point for the recycling of electrical and electronic equipment. By ensuring this product is disposed of correctly, you will help prevent potential negative consequences for the environment and human health, which could otherwise be caused by inappropriate waste handling of this product. For more detailed information about recycling of this product, please contact your local city office, your household waste disposal service or the shop where you purchased the product.

# Contents

## For the User





|   |           |
|---|-----------|
| <b>Important Safety Information</b>                           | <b>2</b>  |
| <b>Description of the Appliance</b>                           | <b>4</b>  |
| <b>The Control Panel</b>                                      | <b>16</b> |
| Touch controls  | 16        |
| How to light a burner   | 17        |
| How to turn off a burner                                      | 18        |
| In case of ignition failure                                   | 18        |
| In case of accidental extinguishing<br>(automatic reignition) | 18        |
| How to turn off all the burners at once                       | 19        |
| Burner safety cut-off function                                | 19        |
| Hob safety cut-off function                                   | 19        |
| Protection against overheating                                | 19        |
| Child safety function   | 20        |
| The electronic timer  | 20        |
| How to programme the burner to switch off                     | 21        |
| How to set the minute minder function                         | 22        |
| <b>Safety and energy-saving advice</b>                        | <b>23</b> |
| <b>Cooking table</b>  | <b>24</b> |
| <b>Maintenance and Cleaning</b>                               | <b>25</b> |
| <b>Something Not Working</b>                                  | <b>26</b> |
| <b>Repairs - After Sales Service</b>                          | <b>27</b> |
| Spare parts   | 27        |

## For the Installer

|   |           |
|---|-----------|
| <b>Installation</b>                       | <b>5</b>  |
| Technical Specifications                  | 5         |
| <b>Electrical Connection</b>              | <b>6</b>  |
| <b>Wiring Diagram</b>                     | <b>7</b>  |
| <b>Important Safety Requirements</b>      | <b>8</b>  |
| <b>Conversion from Natural Gas to LPG</b> | <b>10</b> |
| <b>Building In</b>                        | <b>13</b> |
| <b>Installation Possibilities</b>         | <b>15</b> |

## Guide to Use the instructions

The following symbols will be found in the text to guide you throughout the Instructions:

-  Safety Instructions
-  Step by step instructions for an operation
-  Hints and Tips
-  Environmental Information

 This appliance complies with the following EEC Directives:  
-**73/23** and **90/683** (on Low Voltage);  
-**89/336** (on Electromagnetic Compatibility);  
-**90/396** (on Gas Appliances);  
-**93/68** (on General Standards) and subsequent amendments;  
-**2002/95**;  
-**2002/96**.

# Description of the Appliance

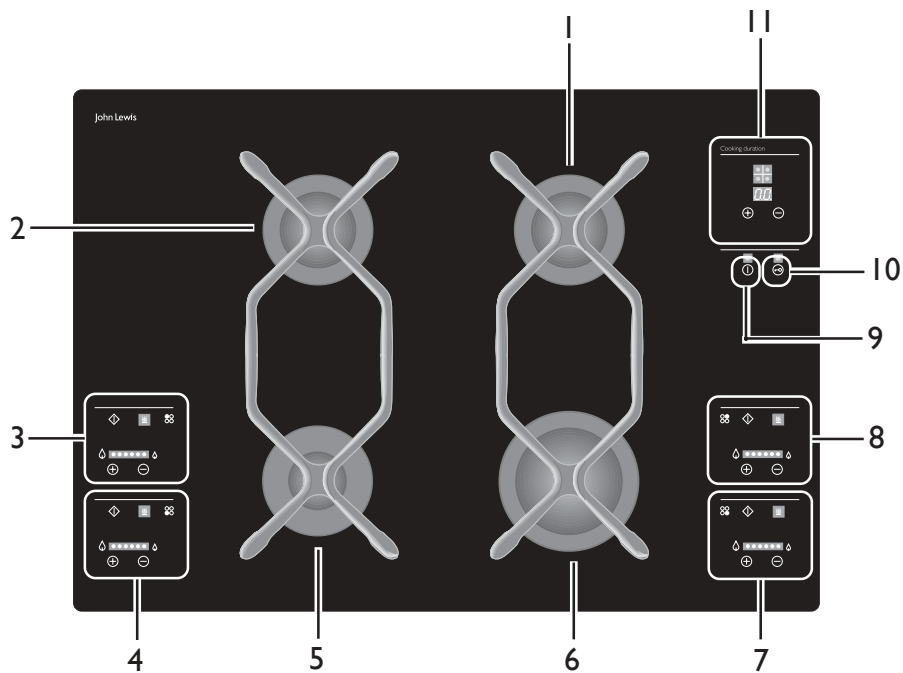

1. Semi-rapid burner
2. Semi-rapid burner
3. Rear left burner control zone
4. Front left burner control zone
5. Auxiliary burner
6. Rapid burner
7. Front right burner control zone
8. Rear right burner control zone
9. Main ON/OFF switch
10. Child safety control
11. Timer control zone

Your new gas hob offers several innovative functions that distinguish it from conventional gas hobs.

- **Electronic control** of all functions.
- **Touch controls** to activate the hob functions simply by touching them with a finger.
- **Electronic Timer** to programme your cooking.
- **Automatic reignition** of the burners if the flame is accidentally extinguished.
- **Residual heat indicator** to advise that the pan supports and the burners are still hot.
- **Children safety device** to prevent the controls from being accidentally operated.
- **General shutdown** to turn off all the burners at once for an emergency.
- **Safety device** in case of power failure or burner ignition failure.

# Installation



It is dangerous to alter the specifications or attempt to modify this product in any way.



Care must be taken to ensure that the appliance does not stand on the electrical supply cable.



Any electrical work required to install this appliance should be carried out by a qualified electrician or competent person.

## Technical Specifications

|                           |   |
|---------------------------|---|
| <b>Gas burner power</b>   |   |
| Rapid burner (large)      | 2.9 kW (Natural gas 20 mbar)<br>2.7 (LPG 28-30/37 mbar) |
| Semirapid burner (medium) | 1.9 kW  |
| Auxiliary burner (small)  | 1.0 kW  |

## Supply connections

### Gas:

R 1/2 inch (1/2 inch male)

### Electric:

230 V 50 Hz supply

|                             |                           |
|-----------------------------|---------------------------|
| <b>Appliance class</b>      | 3                         |
| <b>Appliance category</b>   | II2H3+                    |
| <b>Appliance gas supply</b> | Natural gas G20 / 20 mbar |
| <b>Overall dimensions</b>   |                           |
| Width                       | 730 mm                    |
| Depth                       | 510 mm                    |
| <b>Cut out dimensions</b>   |                           |
| Width                       | 710 mm                    |
| Depth                       | 470 mm                    |

# Electrical Connection



**THIS HOB MUST BE EARTHED.**



Any electrical work required to install this hob should be carried out by a qualified electrician or competent person, in accordance with the current regulations.

## Electrical requirements

Any permanent electrical installation must comply with the latest I.E.E. Regulations and local Electricity Board regulations. For your own safety this should be undertaken by a qualified electrician, e.g. your local Electricity Board, or a contractor who is on the roll of the National Inspection Council for Electrical Installation Contracting (NICEIC).

## Electrical connections

This hob is designed to be connected to a 230 V 50 Hz AC electrical supply.

Before switching on, make sure the electricity supply voltage is the same as that indicated on the hob rating plate. The rating plate is located on the bottom of the hob. A copy is attached on the back cover of this book.

The hob is supplied with a 3 core flexible supply cable.

This has to be provided with a proper plug, able to support the load marked on the identification plate. The plug has to be fitted in a proper socket.

In the event of having to change the fuse, a 3amp ASTA approved (BS 1362) fuse must be used.

Should the plug need to be replaced for any reason, the wires in the mains lead are coloured in accordance with the following code:

Green and Yellow - Earth  
Blue - Neutral  
Brown - Live



- Connect the green and yellow (earth) wire to the terminal in the plug which is marked with the letter 'E' or the earth symbol  or coloured green and yellow.
- Connect the blue (neutral) wire to the terminal in the plug which is marked with the letter 'N' or coloured black.
- Connect the brown (live) wire to the terminal in the plug which is marked with the letter 'L' or coloured red.

Upon completion there must be no cut, or stray strands of wire present and the cable clamp must be secure over the outer sheath.



A cut off plug inserted into a 13 amp socket is a serious safety (shock) hazard. Ensure that the cut off plug is disposed of safely.

## Permanent connection

In the case of a permanent connection, it is necessary that you install a double pole switch between the hob and the electricity supply (mains), with a minimum gap of 3 mm between the switch contacts and of a type suitable for the required load in compliance with the current electric regulations.



**The switch must not break the yellow and green earth cable at any point. It is necessary that the yellow / green earthwire is about 2 cm longer than the live and neutral ones.**

Ensure that the hob supply cable does not come into contact with surfaces with temperatures higher than 50 deg. C.

## Supply cable replacement

The cable used to connect the hob to the electrical supply must comply to the specifications given below.

| Min. size Cable/flex | Cable / flex type | Fuse |
|----------------------|-------------------|------|
| 0.75 mm <sup>2</sup> | H05 V2V2-F (T90)  | 3 A  |

**The manufacturer declines any liability should these safety measures not be observed.**

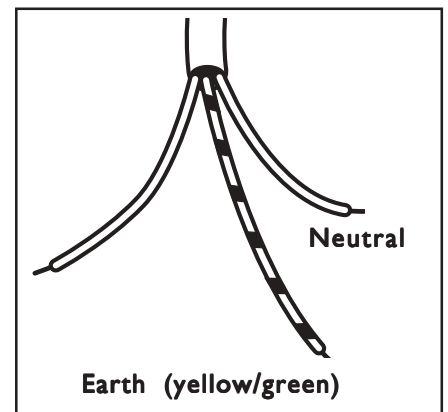

# Wiring Diagram

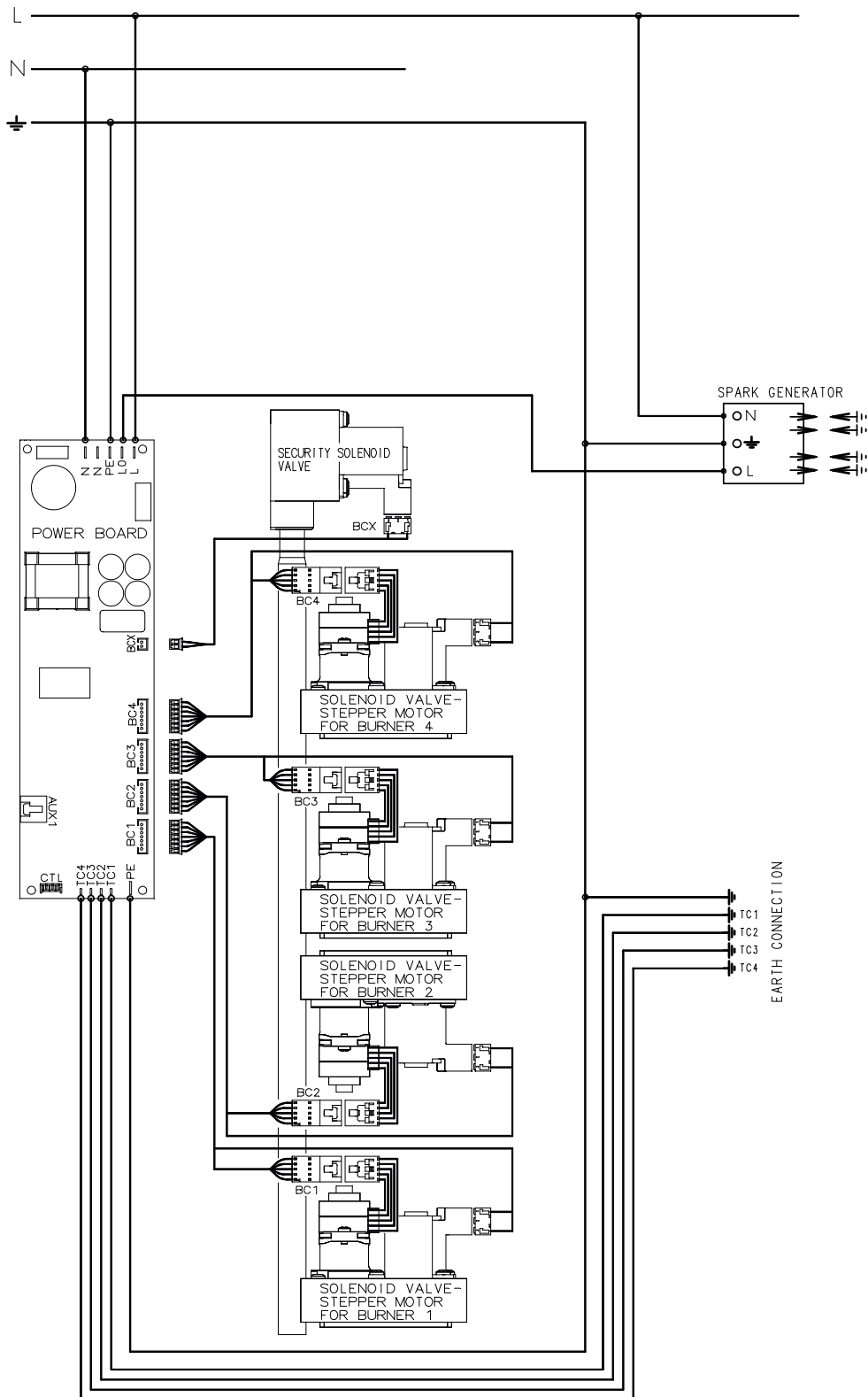

# Important Safety Requirements

This hob must be installed in accordance with the Gas Safety (Installation and Use) Regulations (Current Edition) and the IEE Wiring Regulations (Current Edition).

For appliances installed in the Republic of Ireland please refer to NSAI- Domestic Gas Installation I.S. 813 Current Editions and the ETCI Rules for Electrical Installations.

## Provision for ventilation

Detailed recommendations are contained in the following British Standards Codes Of Practice: B.S. 6172/ B.S. 5440, Part 2 and B.S. 6891 Current Editions.

The hob should not be installed in a bed sitting room with a volume of less than 20 m<sup>3</sup>. If it is installed in a room of volume less than 5 m<sup>3</sup> an air vent of effective area of 110 cm<sup>2</sup> is required. If it is installed in a room of volume between 5 m<sup>3</sup> and 10 m<sup>3</sup> an air vent of effective area of 50 cm<sup>2</sup> is required, while if the volume exceeds 11 m<sup>3</sup> no air vent is required. However, if the room has a door which opens directly to the outside no air vent is required even if the volume is between 5 m<sup>3</sup> and 11 m<sup>3</sup>. If there are other fuel burning appliances in the same room, B.S. 5440 Part 2 Current Edition, should be consulted to determine the requisite air vent requirements.

For appliances installed in the Republic of Ireland please refer to the NSAI- Domestic Gas Installation I.S. 813 Current Editions Table Four.

## Location

The hob may be located in a kitchen, a kitchen/diner or bed sitting room, but not in a bathroom or shower room.

Before making the cut out in the worktop ensure that the edges of the hob that are to be near either a side or rear wall have a minimum distance of 55 mm. between the edge of the hob and the wall.

The minimum distance combustible material can be fitted above the hob is 400 mm. If it is fitted below 400 mm. a space of 50 mm. must be allowed from the edges of the hob. The minimum distance combustible material can be fitted directly above the hob is 700 mm.

A minimum distance of 100 mm. must be left between the side edges of the hob and any adjacent cabinets or walls.

For appliances installed in the Republic of Ireland please refer to NSAI- Domestic Gas Installation I.S 813 Current Edition Section 7- Permitted Locations of Appliance.

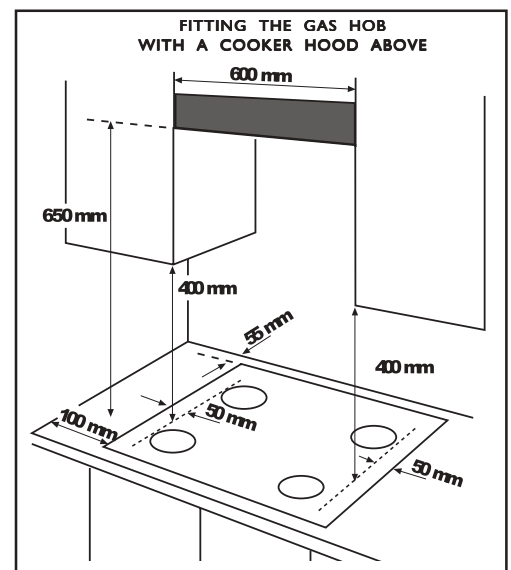
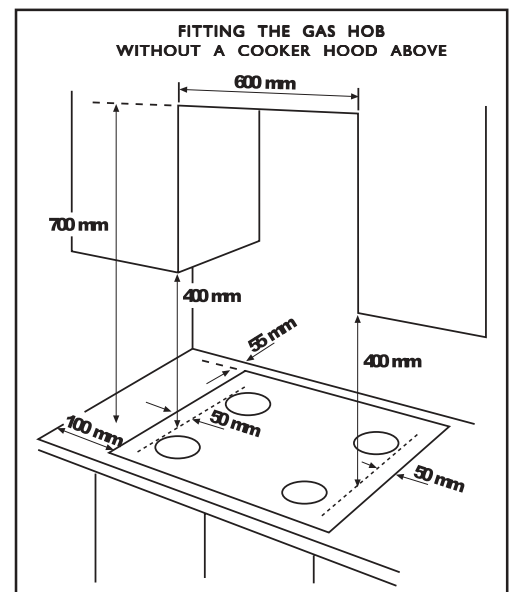



## Connection



**IMPORTANT:** This hob must be installed by a competent person to the relevant Gas Standards.

Any gas installation must be carried out by a competent person.

The manufacturer will not accept liability, should the above instructions or any of the other safety instructions incorporated in this book be ignored.

Carry out connection to the gas supply using a rigid metal pipe with connections conforming to the rules in force, or with a flexible s/steel tube conforming to the relevant rules in force, limited to those whose max. length is 2 m. If flexible metal tubes are used, make sure they do not come into contact with mobile parts or are crushed. Pay the same attention also when an oven and top combination is provided for. The appliance gas inlet connection is 1/2" cylindrical threaded male. Screw the parts together without using excessive force.



**IMPORTANT:** After installation, always check the perfect tightness of all the connections, using a soapy solution. NEVER carry out this check with a flame.

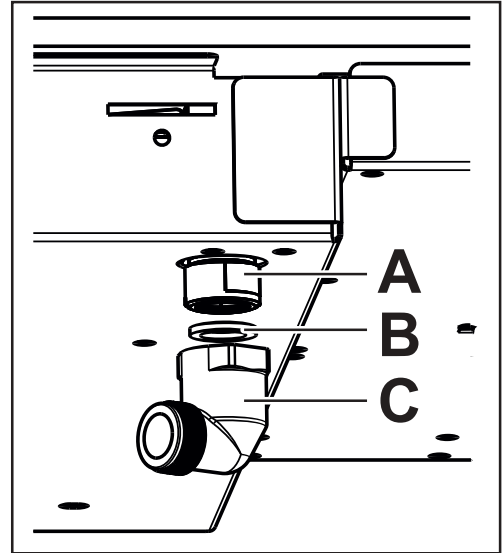

- A) Gas ramp end with nut
- B) Washer
- C) Elbow

# Conversion from Natural Gas to LPG

## Replacing the injectors

1. Remove the pan supports.
2. Remove the burner caps and crowns.
3. Using a 7 mm socket spanner unscrew and remove the injectors, then replace them with the ones required for the new type of gas (see the table "Burner characteristics").
4. Reassemble the parts, following the same procedure backwards.
5. Replace the Gas Type Label (located near the gas supply connection) with the one corresponding to the new type of gas. The label is supplied in the accessories plastic bag.

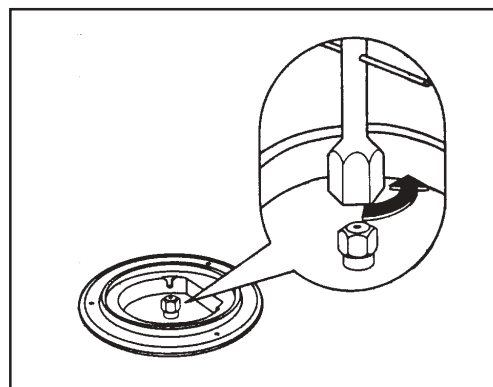



Should the feeding gas pressure be different or variable compared with the required pressure, an appropriate pressure regulator must be fitted on the gas supply pipe, in compliance with the rules in force.



## Burner characteristics

| GAS TYPE                           | BURNER TYPE | INJECTOR REFERENCE<br>I/100 mm | NOMINAL THERMAL POWER<br>kW | REDUCED THERMAL POWER<br>kW | NOMINAL FLOW RATE |     | FEEDING PRESSURE<br>mbar |
|------------------------------------|-------------|--------------------------------|-----------------------------|-----------------------------|-------------------|-----|--------------------------|
|                                    |             |                                |                             |                             | m <sup>3</sup> /h | g/h |                          |
| NATURAL GAS (G20)                  | Rapid       | 119                            | 2.9                         | 0.65                        | 0.276             | -   | 20                       |
|                                    | Semirapid   | 96                             | 1.9                         | 0.45                        | 0.181             | -   |                          |
|                                    | Auxiliary   | 70                             | 1.0                         | 0.33                        | 0.095             | -   |                          |
| LIQUID GAS<br>(Butane/<br>Propane) | Rapid       | 86                             | 2.7                         | 0.65                        | -                 | 196 | 28-30/37                 |
|                                    | Semirapid   | 71                             | 1.9                         | 0.45                        | -                 | 138 |                          |
|                                    | Auxiliary   | 50                             | 1.0                         | 0.33                        | -                 | 73  |                          |

## Setting the hob for the new gas type

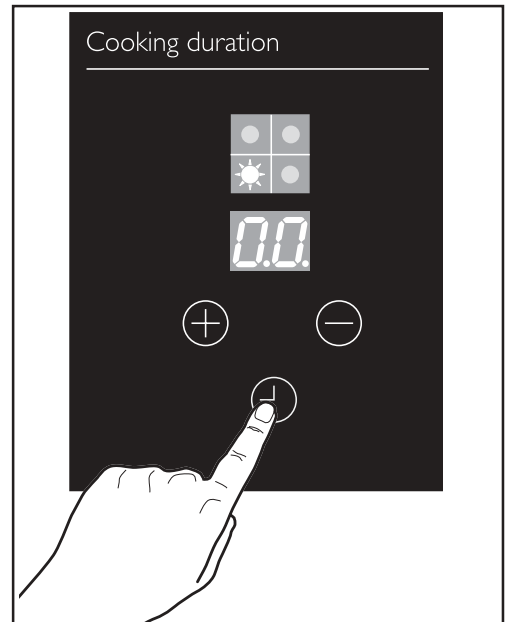
1. If necessary, activate the hob by touching the main ON/OFF Control  for about 3 seconds.
2. Touch the Timer Control  repeatedly to select the auxiliary burner (front left burner) on the burner selection display .



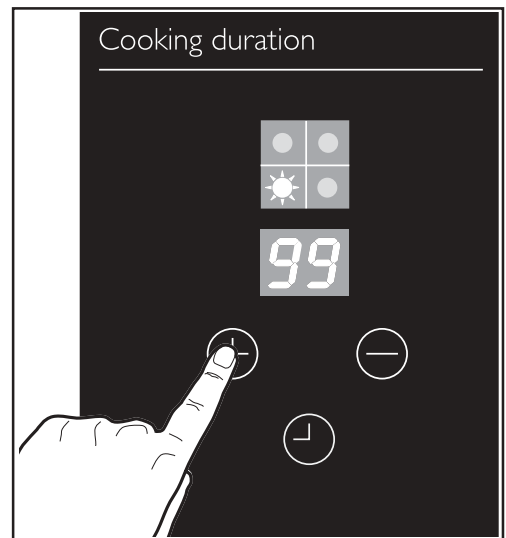

3. Touch the Increasing Control  and hold the finger on it until the value 99 appears on the time display. Then, touch the Decreasing Control  and hold the finger on it until the value 80 is displayed.



4. Then, touch the Increasing Control  until 83 is displayed. At this point, the hob is set to the “Gas Change” mode and the current gas setting appears on the display:
  - **n0** stands for gas G20 (20 mbar)
  - **n1** for gas G30 (28-30/37 mbar).



IMPORTANT: setting **n2** does not allow the hob to function.

5. Touch the Decreasing Control  to select the required type of gas.
6. After selecting the type of gas, switch off the hob touching the main ON/OFF Control .
7. Touch the main ON/OFF Control  again to reactivate the hob. The appliance is automatically set to the normal “User Mode”.
8. Light all the burners and adjust their flame to minimum, in order to check the flame stability (visual check).
9. At the same time, check the flame aspect (visual check). If both the flame stability and the flame aspect are satisfactory, the setting of the hob for the new gas type is completed. If the flame stability is not satisfactory, carry out an additional adjustment as described in the following paragraph.

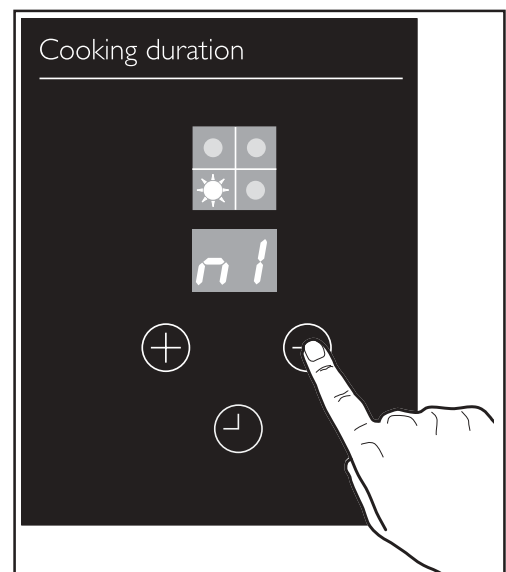



## Minimum flame adjustment

If it is necessary to adjust the minimum flame setting, proceed as follows:

1. Carry out the steps described in the paragraph "Setting the hob for the new gas type" - points 1, 2, 3, 4 and 5.
2. Light the burner to be adjusted by touching the Burner Ignition Control .

The burner lights at the maximum flame level and, after a regular flame is obtained, it sets at the minimum flame level.

3. If the minimum level is too low or not satisfactory to maintain the burner lit, touch the Increasing  or Decreasing  Control to carry out a fine adjustment (visual check).
4. Switch off the hob touching the main ON/OFF Control .

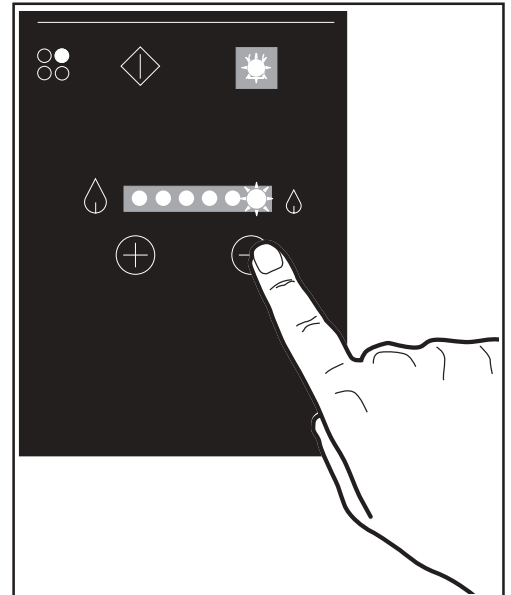

# Building In

A = Auxiliary burner  
SR = Semirapid burner  
R = Rapid burner

Dimensions are given  
in millimetres

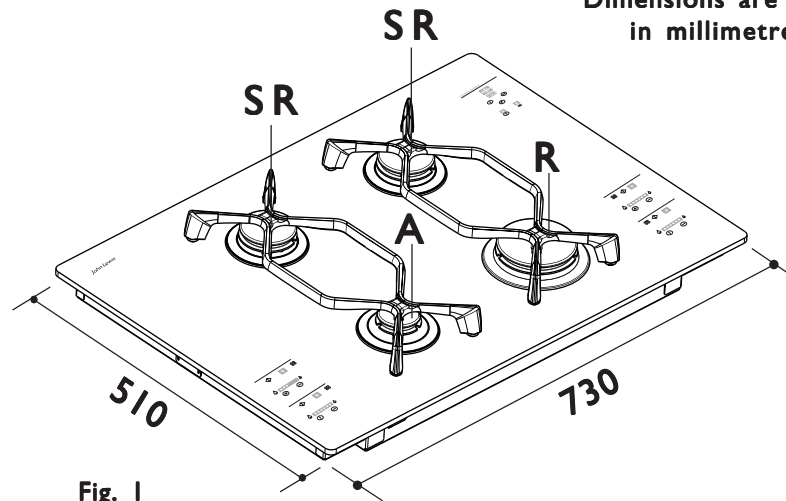

The hob is designed to be inserted in modular kitchen units with depth of 550 - 600 mm and having proper characteristics. The building-in is also possible in modular units with a 600 mm width: in this case, the cut-out in the worktop must be carried out as shown in Fig. 2.

The worktop must be at least 30 mm thick.

If the worktop is thicker than 50 mm, it is possible to install the hob on modular units of any width.

Any unit (furniture unit, household appliance, etc..) placed near the unit which the hob is built in, shall not exceed the worktop height.

 A minimum clearance of 100 mm between the cut-out in the worktop and any side wall exceeding the worktop height must be observed.

The hob dimensions and the cut-out dimensions are given in fig. 1 and 2.

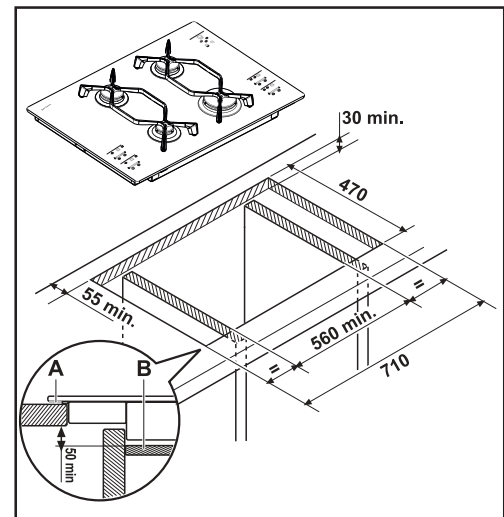

A) Worktop  
B) Removable Panel

## Fitting the hob to the worktop

Before fitting the hob into the cut out, an adhesive seal must be fitted to the underside outside edge of the hob. It is essential that no gaps are left in this seal in order to prevent spillage near the hob seeping into the cabinet below.

 Proceed as follows:

1. Remove the pan supports, the burner caps and crowns and turn the hob upside down, taking care that the spark plugs and the thermocouples are not damaged in this operation.
2. Place the sealing gasket all around the glass top edge as shown in Fig. 3.
3. Fit the hob in the cut out and push it down until the glass top and the worktop make contact, as shown in Fig. 4.  
The side springs ensure centering.

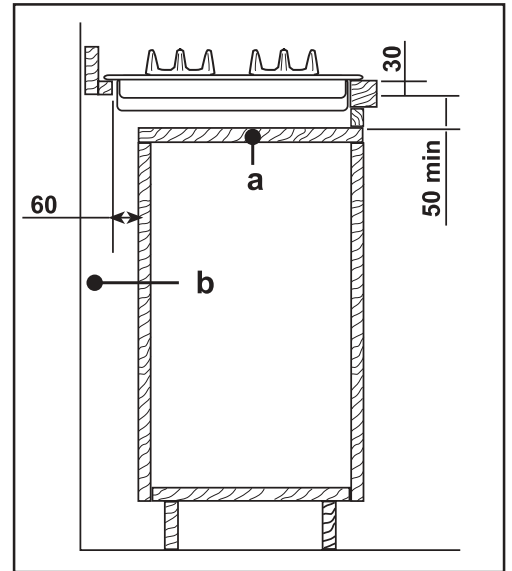
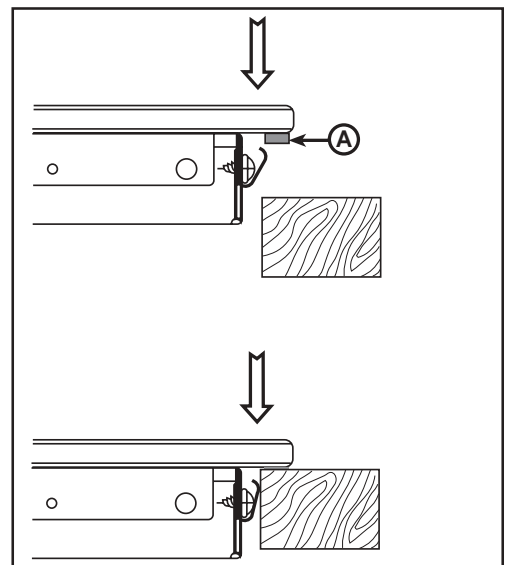

Fig. 3



A) Seal

Fig. 4

# Installation Possibilities

## Building over a kitchen unit with door

Proper arrangements must be taken in designing the furniture unit, in order to avoid any contact with the bottom of the hob which can be heated when it is operated. The recommended solution is shown in Fig. 5.

The panel fitted under the hob ("a") should be easily removable to allow easy access if technical assistance is needed. See also Fig. 2.

The space behind the kitchen unit ("b") can be used for connections.

**Dimensions are in mm**

## Building over a unit with an oven

The recesses for the hob and the oven must comply the indication given in Figs. 6 and must be provided with openings to allow a continuous supply of air.

Two possible solutions to avoid excessive overheating are described in Fig. 7 and 8.

The electrical connection for the hob and the oven must be carried out separately, for safety reasons and also to allow the oven to be easily removed from the unit, if necessary.

Hanging furniture units or hoods must be placed at 650 mm. minimum from the hob (Fig. 6).

 The electronic gas hob can only be installed over a built-in oven equipped with cooling fan.

 If the hob is installed over a built-in oven equipped with pyrolytic cleaning function, the hob must not be in use while the pyrolytic cleaning cycle of the oven is running.

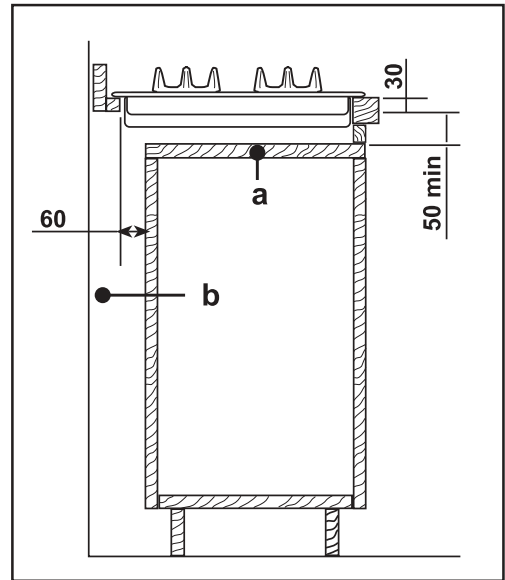

a) removable panel  
b) space for connections

**Fig. 5**

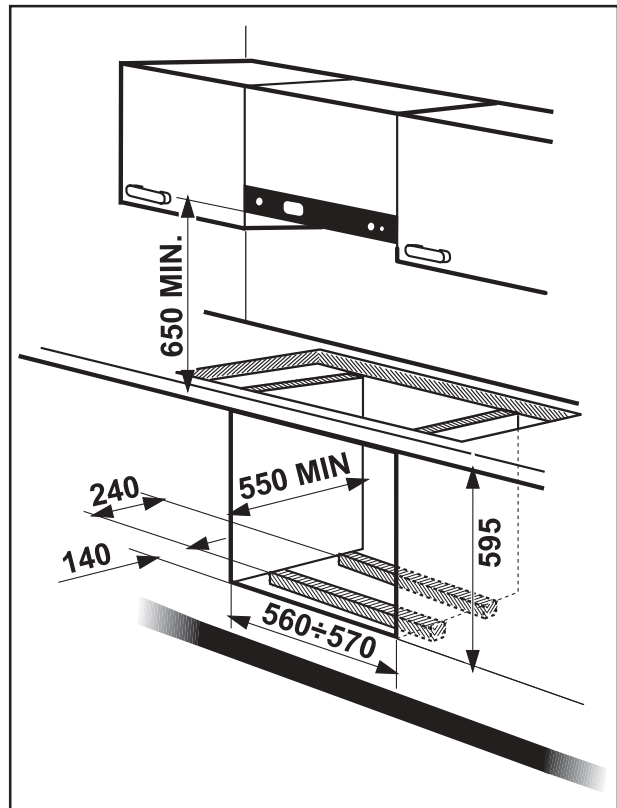

**Fig. 6**

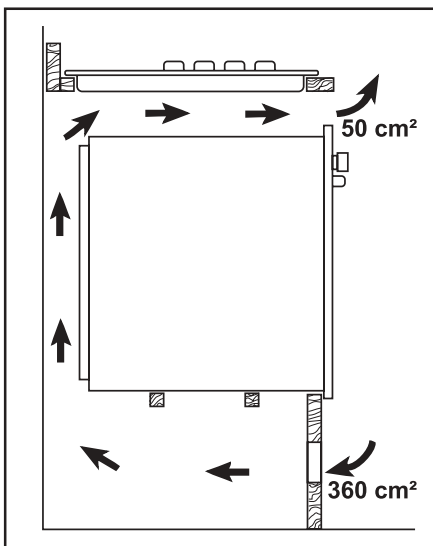

**Fig. 7**

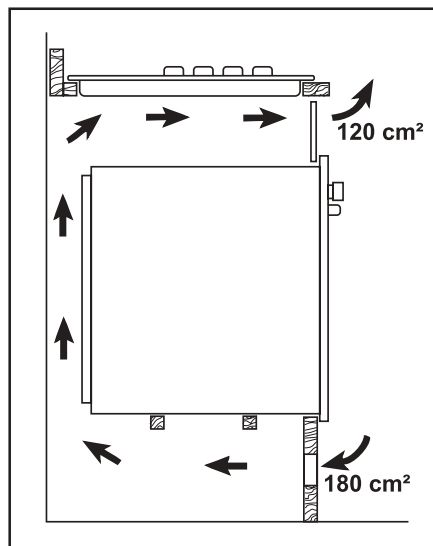

**Fig. 8**

# The Control Panel



Before using the appliance, remove all packaging, including the advertising labels and any protective film.



Keep packaging away from children.

## Touch controls

The hob is supplied with special Touch Controls. To operate your hob, simply touch the required control with a fingertip. Ensure to only touch one control at a time during use.

Here follow the symbols for the main Touch Controls, and the relevant indicators



Main ON/OFF Touch Control



Burner Ignition Touch Control



Flame level indicators



Increasing Touch Control for the flame level



Decreasing Touch Control for the flame level



Residual heat indicator

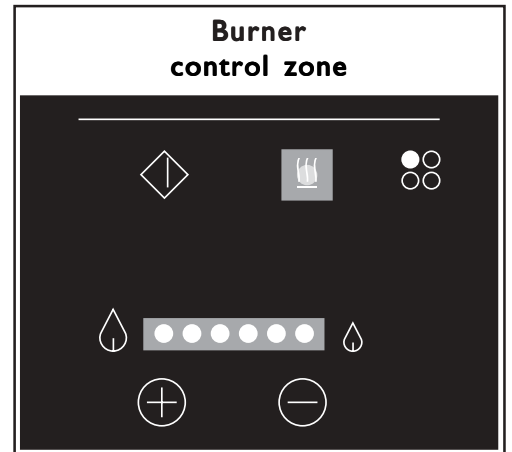





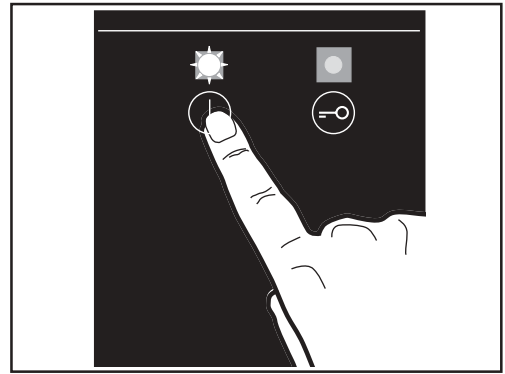

## How to light a burner

1. Touch the main ON/OFF Control  for about 3 seconds to switch on the hob. The red indicator above the touch control lights up, an acoustic signal sounds and the hob is ready to use.



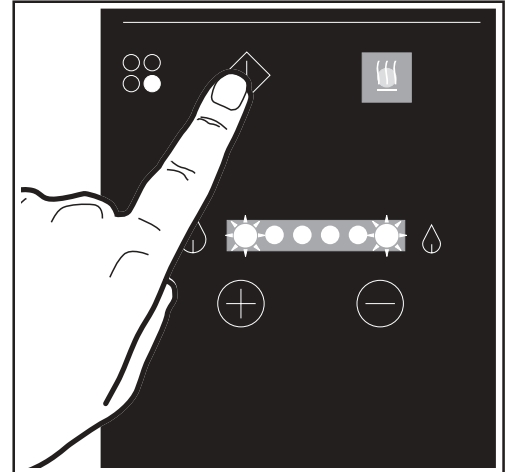

2. Touch the Burner Ignition Touch Control  of the required burner. The flame level indicators located right above the symbols  and  illuminate.



3. Within about 3 seconds, touch the Increasing  or Decreasing  Touch Control to light the burner.

- If touch control  is selected, the burner automatically lights at maximum flame level (all the flame level indicators illuminate).

- If touch control  is selected, the burner automatically lights at medium flame level (three flame level indicators illuminate).

4. To adjust the burner flame level, use the Increasing  or Decreasing  Touch Control.

The residual heat indicator  lights up immediately after the burner is lit.

This means that the cooking zone is getting hot: the indicator remains on until the pan support and the burner have cooled down.

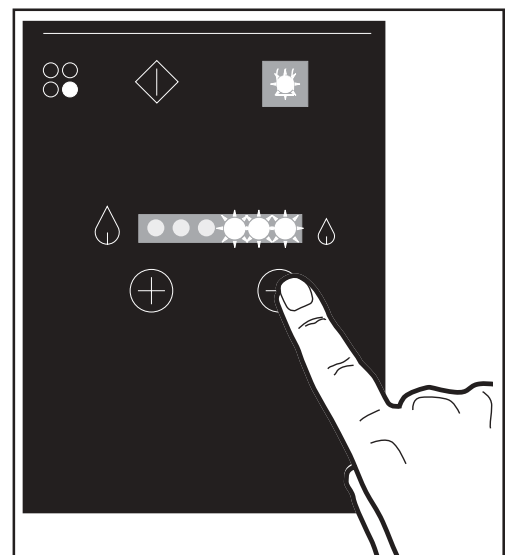
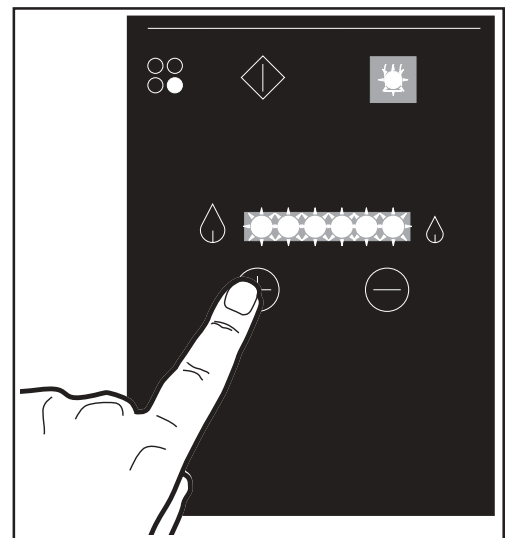

## How to turn off a burner

- To turn off a burner press the relevant Burner Ignition Touch Control . All the flame level indicators go off.  
The residual heat indicator remains on until the pan support and the burner have cooled down.



## In case of ignition failure

The hob ignition device generates a series of small sparks for about 6 seconds.

If the flame does not light during this period, the gas flow to the burner is interrupted. After 3 seconds, the ignition device automatically repeats the ignition procedure for another 6 seconds.

After three failed ignition attempts, a safety device is set on the burner. The flame level indicators flash.

 **Caution!** When the safety device is set on a burner, the burner controls cannot be operated for about 60 seconds.

After 60 seconds, you can remove the safety device on the burner by touching both the Increasing Controls  and the Decreasing Control  at the same time.

Then, follow the instructions given in the paragraph “How to light a burner”.

 **Caution!** Check that the burner cap is correctly positioned (see diagram).  
If the ignition problem persists, refer to chapter “Something not working”.

 Never use a manual spark gas-lighter if the burner ignition device does not work correctly. If necessary, use a match.

## In case of accidental extinguishing (automatic reignition)



If the burner flame is accidentally extinguished (draughts, spilling of liquids, etc.), the gas flow is immediately interrupted.

After about 20 seconds, the ignition device automatically repeats the ignition procedure.

Upon reignition, the burner flame is first set at maximum level, then it is automatically adjusted to the level set before it was accidentally extinguished.

If three consecutive reignition attempts fail, a safety device is set on the burner. The flame level indicators and the residual heat indicator flash.

 **Caution!** When the safety device is set on a burner, the burner controls cannot be operated for about 60 seconds.

After 60 seconds, you can remove the safety device on the burner by touching both the Increasing Controls  and the Decreasing Control  at the same time.

Then, follow the instructions given in the paragraph “How to light a burner”.

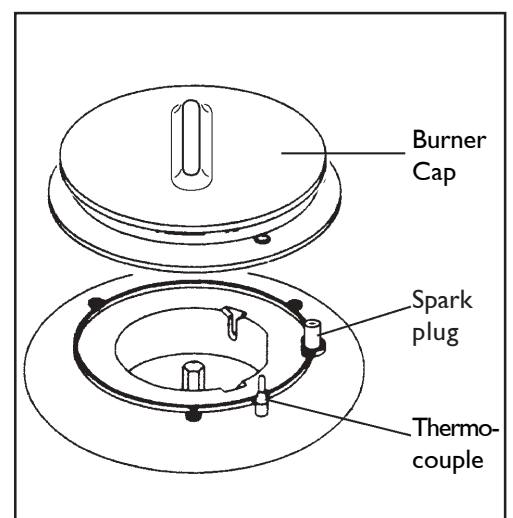
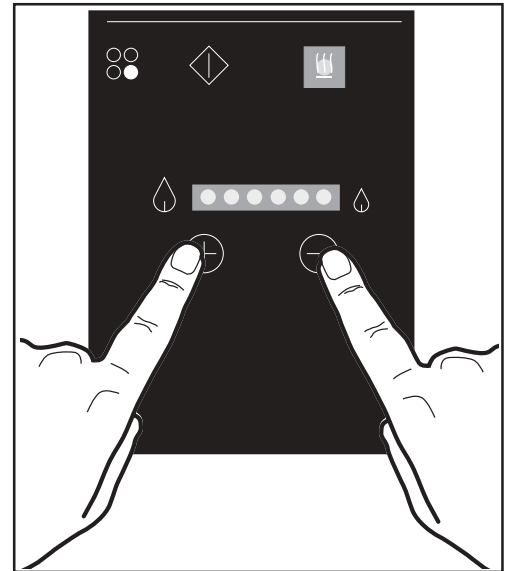



## How to turn off all the burners at once

In case of unexpected safety hazard (spilling of liquids, children hazard, etc.), you can immediately turn off all the hob burners at once by touching the main ON/OFF Control





## Burner safety cut-off function

If you leave one or more burners lit and unattended for a long time (that is, you do not touch any control for at least 4 hours), each lit burner is automatically turned off and a safety device is set on it.

 If you select the burner that does not work with the Timer Control  **Code number 10** flashes in the cooking time display.

 Caution! When the safety device is set on a burner, the burner controls cannot be operated for about 60 seconds.

After 60 seconds, you can remove the safety device on the burner by touching both the Increasing Controls  and the Decreasing Control  at the same time.

Then, follow the instructions given in the paragraph "How to light a burner".



## Hob safety cut-off function

If no burner is on but the hob is activated (the red indicator above the touch control  is on), the hob is automatically switched off if no control is operated within 30 minutes.



## Protection against overheating

If the hob is used intensively, e.g. several burners at maximum level for a long time, a temperature sensor detects possible overheating and automatically adjusts all the lit burners to minimum.

If the hob temperature keeps rising although the flame level has been reduced, all the lit burners are automatically turned off and a safety device is set on all the four burners.

 If you select all the burners with the Timer Control  (one at a time) **Code number 9** flashes in the cooking time display.

 Caution! When the safety device is set on all the burners, their controls cannot be operated for about 60 seconds.

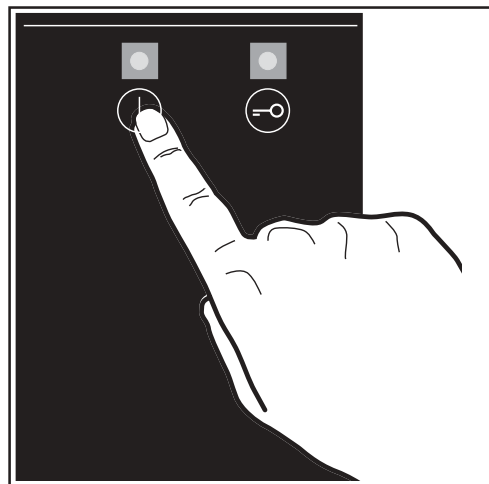

After the 60 seconds, you can reactivate all the burners by touching the Increasing Control  and the Decreasing Control  of one of the four burners at the same time.

Once the safety device has been removed, wait until the hob has cooled down before using it again.





## Child safety function

To avoid children operating the hob controls, it is possible to lock them.

1. Touch the “Key” Control  for about 3 seconds. The red indicator above the “Key” symbol  lights up and an acoustic signal sounds.

Now all the hob controls are locked, except the main ON/OFF Touch Control.

Any lit burner keeps operating, but cannot be adjusted.

2. To unlock the hob controls, touch the “Key” Control  for about 3 seconds. The red indicator above the “Key” symbol  goes off and an acoustic signal sounds.

 It is highly recommended to activate the child safety function every time the hob is not operated.

 In case of a power failure, the hob stores the children safety function setting in the system memory. If the controls are locked at the time of the power failure, they will still be locked when the power is restored.

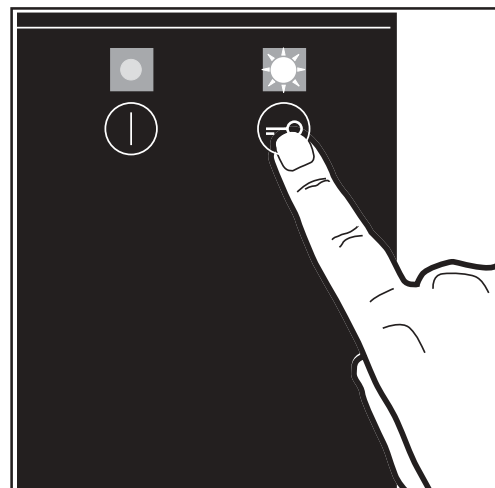

## The electronic timer

Your hob is supplied with an electronic timer enabling you to programme the cooking duration. The timer can also be used as a minute minder, when the hob is not in use.

 The hob can even be used manually, i.e. without any programming.

The timer only operates when the hob is switched on by means of the main ON/OFF Control .

Here follow the symbols in the Timer Control Zone:

 Touch Control to activate the Timer and select a burner.

 Cooking time display

 Burner selection display



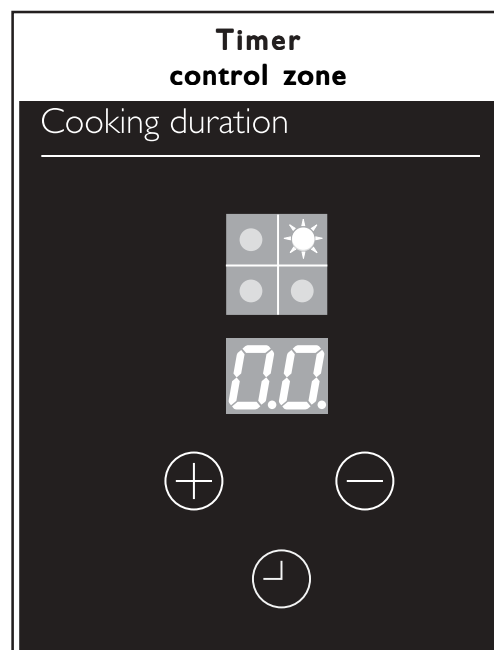

 Increasing Touch Control for the time setting.

 Decreasing Touch Control for the time setting.





## How to programme a burner to switch off

To programme a burner to switch off, proceed as follows:

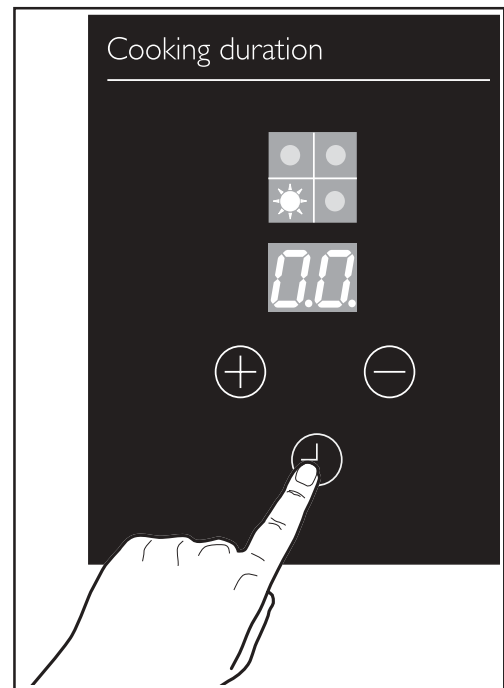

1. If necessary, activate the hob by touching the main ON/OFF Control  for about 3 seconds.
2. Light the burner and adjust the flame level using the Increasing  or Decreasing  controls (see par: "How to light a burner").
3. Activate the Timer by touching the Timer Control  and select the required burner by repeatedly touching the Timer Control .



4. Set the required cooking time touching the Increasing  and Decreasing  Controls.  
(max. time: 99 minutes).



Once the cooking time has been set, the burner selection can no longer be changed.

If you want to change burner, you must set the cooking time to zero by means of the Decreasing  control,

-  and then change the burner selection by touching the Timer Control .

5. The timer starts the countdown a few seconds after the cooking time has been set.
6. During the last ten seconds, the timer starts beeping to advise that the cooking time is about to end.
7. An acoustic signal sounds at the end of the cooking time.  
To stop the acoustic signal, touch the Timer Control .

### To adjust the cooking time:

1. Touch the Increasing  or Decreasing  Control or at any time to adjust the time setting.

### To cancel the time setting:

1. Touch the Decreasing  Control to set the cooking time to zero.

 It is possible to programme the switch-off of **ONLY** one burner at a time.

 You can set the cooking time as well when the burner is already lit.

For example, you can bring a pot of water to the boil, then put some vegetables, meat or pasta and programme the required time for their cooking.

 The residual heat indicators remain on even when the hob is off, until the burner and the pan supports have cooled down.

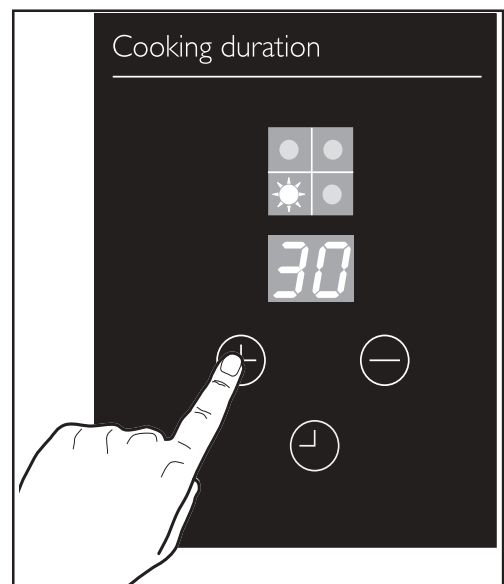



## How to set the minute minder function



You can use the timer as a simple minute minder when none of the burners are operating.

The hob must be activated in order to use the timer as a minute minder.

Proceed as follows:

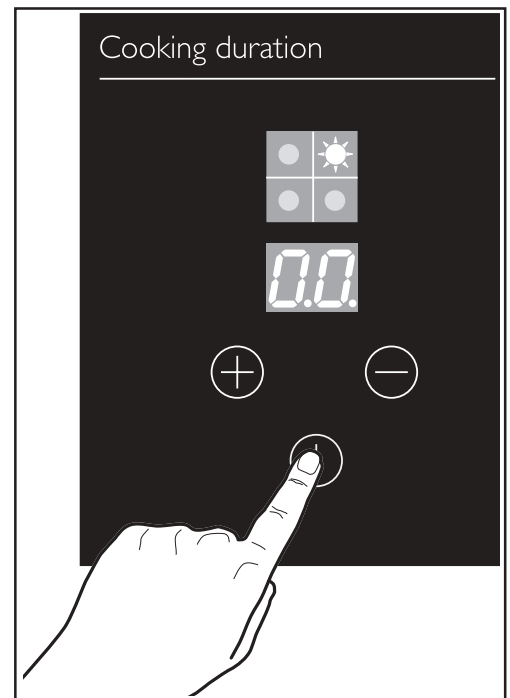
1. If necessary, activate the hob by touching the main ON/OFF Control  for about 3 seconds.
2. Touch the Timer Control  to activate the timer.



3. Touch the Increasing  or Decreasing  controls to set the required time (max. time: 99 minutes).
4. The timer begins the countdown a few seconds after the time has been set.
5. During the last ten seconds, the timer starts beeping to advise that the timed period is about to end.
6. An acoustic signal sounds at the end of the timed period. To stop the acoustic signal, touch the Timer Control .

### To adjust the time setting:

1. Touch the Increasing  or Decreasing  Control or at any time to adjust the minute minder setting.

### To cancel the time setting:



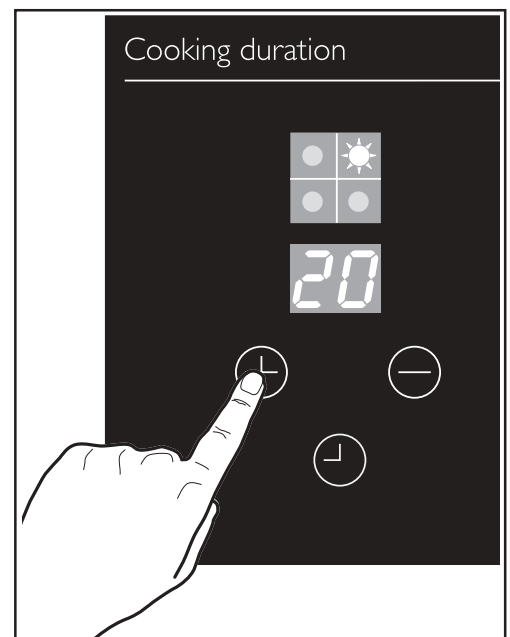







1. Touch the Decreasing  Control to set the minute minder to zero.



# Safety and energy-saving advice

## For a correct use of the hob







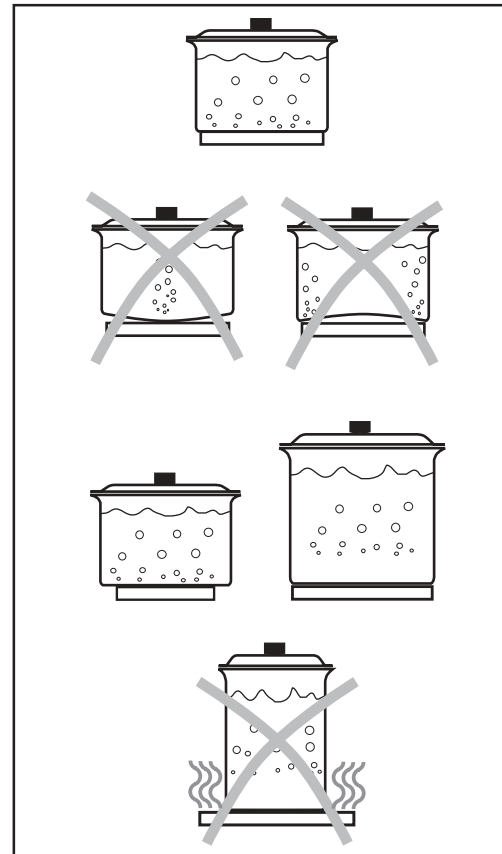









To ensure maximum burner efficiency and lower gas consumption, you should only use pots and pans with a flat bottom fitting the size of the burner used (see table).

-  If you use a saucepan which is smaller than the recommended size, the flame will spread beyond the bottom of the vessel, causing the handle to overheat.
-  Pots must never be placed onto the control zones.
-  Always turn the flame down or off before removing pots from the burners.
-  Take care when frying food in hot oil or fat, as the overheated splashes could easily ignite.
-  For an easier ignition of the burner, light it before placing the pan on the pan support.
-  Unstable or misshapen pans should not be used on the hob as unstable pans can cause an accident by tipping or spillage.
-  It is advisable to cook with lids on.
-  By using a pressure cooker you will obtain further energy-saving and shorter cooking times.
-  As soon as a liquid starts boiling, turn down the flame so that it will barely keep the liquid simmering.
-  Avoid cooking with potstones, earthenware pots or cast iron plates. Also, avoid using aluminium foil for protecting the top during operation.

| Burner             | diameter min. | diameter max. |
|--------------------|---------------|---------------|
| Large (rapid)      | 160 mm        | 240 mm        |
| Medium (semirapid) | 120 mm        | 220 mm        |
| Small (Auxiliary)  | 80 mm         | 160 mm        |

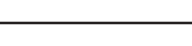

# Cooking table

| DISHES            |                   | Recommended cooking time<br>(Where no recommendation is given, times should be set according to your personal requirements) | RAPID<br> | AUXILIARY<br> | SEMI-RAPID<br> | BURNER POWER<br> |
|-------------------|-------------------|---|---|--|---|---|
| <b>Soups</b>      | Broths            | 15-20 minutes   | x   |  |   |                  |
| <b>Fish</b>       | Court-bouillon    |   | x   |  |   |                  |
| <b>Sauces</b>     | Hollandaise       |   |   |  | x   |                  |
|                   | Bechamel          | 10 minutes  |   |  | x   |                  |
|                   | Endives           |   | x   |  |   |                  |
| <b>Vegetables</b> | Peas in sauce     | 25-30 minutes   | x   | x  |   |                  |
|                   | Provence tomatoes | 15-20 minutes   | x   | x  |   |   |
|                   | Fried potatoes    |   | x   | x  |   |                  |
| <b>Meat</b>       | Pasta             |   | x   |  |   |   |
|                   | Steak (in pot)    |   | x   |  |   |   |
|                   | Fried escalope    | 10-12 minutes   | x   |  |   |   |
| <b>Frying</b>     | Chips             | 18-22 minutes   | x   |  |   |                  |
| <b>Desserts</b>   | Rice pudding      | 35 minutes  |   |  | x   |                  |
|                   | Stewed fruit      |   | x   |  | x   |                  |
|                   | Pancakes          | 3-4 minutes   |   |  | x   |                 |
|                   | Chocolate         | 5-6 minutes   |   |  | x   |                |
|                   | Custard           | 20-25 minutes   |   |  | x   |                |

 Where two burners are indicated in the table, it is recommended that you choose the burner taking into consideration the quantity of food to be cooked.



# Maintenance and Cleaning

 Before any maintenance or cleaning can be carried out, you must **DISCONNECT** the hob from the electricity supply and wait until it has cooled down.

 This appliance cannot be cleaned with steam or with a steam cleaning machine.

## The hob top

Regularly wipe over the hob top using a soft cloth well wrung out in warm water to which a little washing up liquid has been added. Avoid the use of the following:

- household detergent and bleaches;
- impregnated pads unsuitable for non-stick saucepans;
- steel wool pads;
- bath/sink stain removers.

Should the hob top become heavily soiled, it is recommended that proper cleaning product is used.

 If scratches or cracks are noticed on the glass top, immediately disconnect the appliance from the electrical supply to avoid the risk of electrical shock. Then, contact your local Service Force Centre and avoid using the appliance until it has been repaired.

## Pan supports

The pan supports are dishwasher proof. If washing them by hand, take care when drying them as the enamelling process occasionally leaves rough edges. If necessary, remove stubborn stains using a paste cleaner.

 Pay attention when replacing the pan supports in order to avoid scratching the glass hob top.

## The burners

The cap and the crown of each burner are secured with two screws. To separate the two pieces, lift the cap, turn it upside down, then undo the two fixing screws as shown in the diagram.

After a thoroughly cleaning, reassemble the two parts and refit the cap in its correct position on the burner.

Frequently wash the burner caps and crowns using hot soapy water and remove marks with a mild paste cleaner. A well moistened soap impregnated steel wool pad can be used with caution, if the marks are particularly difficult to remove.

For stubborn stains, use normal non-abrasive cleaners or specific products available on the market. **NEVER** use scouring pads, steel wool or acids for cleaning.

## The ignition system

The electric ignition is obtained through a spark plug and a metal electrode (letter A).

Keep these components clean, to avoid difficult lighting, and check that the burner crown holes are not obstructed.

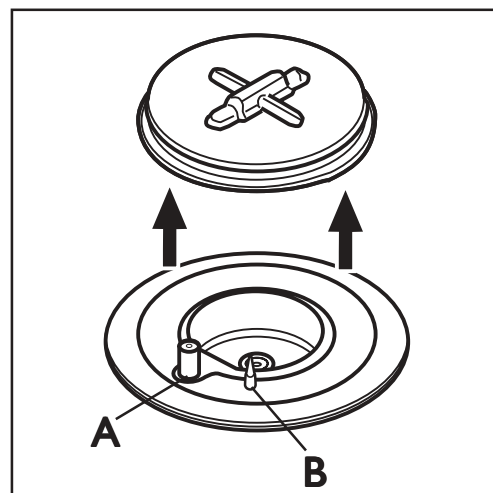
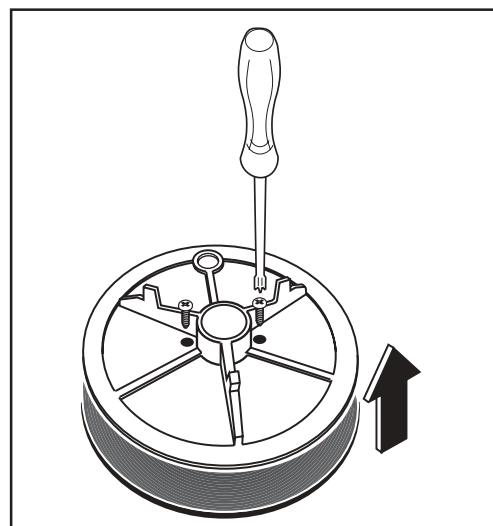
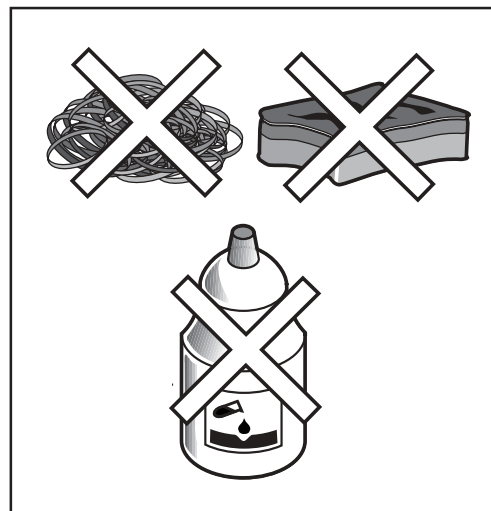

- A** - Spark plug  
**B** - Thermocouple

# Something Not Working

If the hob is not working correctly, please carry out the following checks, before contacting your local Service Force repair agent.

In the event of any other fault codes that arise, disconnect the appliance from the electrical supply for a few seconds (take out the fuse from the housing wiring system). If the fault code is displayed again, please call your local Service Force repair agent and report the fault code.

**IMPORTANT:** If you call out an engineer to a fault listed below, or to repair a fault caused by incorrect use or installation, a charge will be made even if the appliance is under guarantee.

| Sympton  | Possible cause  | Solutions   |
|--|---|---|
| THE HOB DOES NOT WORK.   | <p>There are blown fuses in the domestic electrical system. Switches are turned off or there is no power at the power outlet.</p> <p>The hob is not activated.</p> <p>The main gas supply tap is closed.</p> <p>The gas bottle is empty.</p> <p>The hob has overheated and a safety device has been set on the four burners.</p> <p>The Child Safety function has been inadvertently activated.</p> | <p>Have the fuses replaced.</p> <p>Reset the switches.</p> <p>Touch the main On/Off Control ①.<br/>Open the tap.</p> <p>Purchase a new bottle.</p> <p>Allow the top to cool (see par. "Protection against overheating").</p> <p>Deactivate the Child Safety function (see par. "Child Safety Function").</p>                |
| A BURNER DOES NOT WORK.  | <p>The safety device has been set on the burner due to repeated ignition failures. The flame level indicators and the residual heat indicator flash.</p> <p>The pan support or the burner cap and crown were not correctly positioned after cleaning.</p> <p>The burner crown holes are obstructed.</p> <p>The defect persists.</p>   | <p>Wait 60 seconds, then follow the instructions given in chapter: "In case of ignition failure".</p> <p>Check the correct position (see par. "In case of ignition failure").</p> <p>Follow the instructions given in the section "Cleaning and maintenance".</p> <p>Contact an authorized technical assistance centre.</p> |
| IT TAKES TOO LONG TO FINISH THE DISHES / THEY ARE COOKED TOO FAST. | <p>The flame level adjustment is not appropriate.</p>   | <p>See paragraph "How to light a burner".</p>   |

# Repairs - After Sales Service

If your hob is not performing satisfactorily; consult the fault finding guide within this instruction manual (“Something Not Working” on the previous page). If a fault occurs which you can not resolve through following the advice and information contained within this instruction manual, the next step is to contact our extended warranty administrators on

**0870 0107887**

They will give you details for your local Service Force Centre. Before calling out an engineer, please ensure you have read the details under the heading “Something Not Working”.

When you contact your local Service Force Centre you will need to give the following details:

1. Your name, address and post code
2. Your telephone number
3. Clear and concise details of fault
4. The purchase date and found on your receipt
5. The model and serial number of the appliance.

These details have been provided separately within the pack containing this instruction manual.

Mod. :.....

PNC :.....

S.N. :.....

**Your hob is covered by a 3 year parts and labour guarantee (see separate details given at point of sale).**

**Please retain your purchase receipt safely for the service engineer to verify the purchase details.**

## Spare parts

This product should be serviced by an authorised service engineer, and only genuine spare parts should be used.

Under no circumstances should you attempt to repair the hob yourself.

Repairs carried out by inexperienced persons may cause injury or serious malfunctioning. Contact our extended warranty administrators on

**0870 0107887**

who will give you details for your local repair agent.

Always insist on genuine spare parts.

**John Lewis Partnership**  
171 Victoria Street  
London SW1E 5NN  
[www.johnlewis.com](http://www.johnlewis.com)