

JLBIIH603

Ceramic glass induction hob

Instruction manual

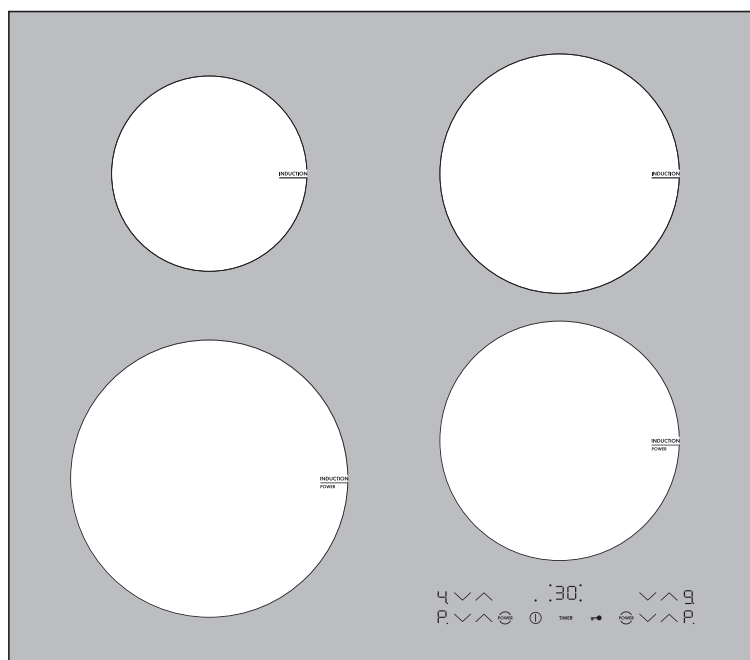

John Lewis

Important Safety Information



It is most important that this instruction manual should be retained with the appliance for future reference. Should the appliance be sold or transferred to another owner, or should you move house and leave the appliance, always ensure that the book is supplied with the appliance in order that the new owner can get to know the functioning of the appliance and the relevant warnings. These warnings have been provided in the interest of safety. You **MUST** read them carefully before use or installation by a qualified person. If you are unsure of the meanings of these warnings contact the John Lewis branch from which you purchased the appliance.

Installation

- This hob must be installed by qualified and competent personnel to the relevant National Standards.
- Refer to Installation Information in chapter “Installation”.
- Remove all packaging, both inside and outside the hob, before using the hob.
- The appliance must not be used as a work surface or as a storage surface.
- Additions or modifications to the appliance are not permitted. Repairs to the appliance must only be carried out by trained registered service engineers.
- Do not place or store flammable liquids, highly inflammable materials or fusible objects (e.g. plastic film, plastic, aluminium) on or near the appliance.
- Built-in appliances may only be used after they have been built in to suitable built-in units and work surfaces that meet the relevant National Standards.
- In the event of faults with the appliance or damage to the glass ceramic (cracks, scratches or splits), the appliance must be switched off and disconnected from the electrical supply to prevent the possibility of an electric shock.

Child safety

- This appliance is designed to be operated by adults. Children should not be allowed to tamper with the controls or play with the product.
- Keep all packaging away from children.

Use

- This hob is intended for domestic cooking only. It is not designed for commercial or industrial purposes.
- Remove stickers and film from the glass ceramic.
- There is the risk of burns from the appliance if used carelessly.
- Cables from electrical appliances must not touch the hot surface of the appliance or hot cookware.
- Overheated fat and oil can ignite quickly. When cooking with fat or oil (e.g. frying chips) do not leave the appliance unattended.
- Switch the cooking zones off after each use.
- The ceramic glass can be damaged by objects falling onto it.
- The edge of the ceramic glass can be damaged by being knocked by the cookware.

- Cookware made of cast iron, cast aluminium or with damaged bottoms can scratch the ceramic glass if pushed across the surface.
- Objects that melt and things that boil over can burn onto the ceramic glass and should be removed straightaway.
- Do not use the cooking zones with empty cookware or without cookware.

Maintenance and Cleaning

- Only clean this hob in accordance with the instructions.
- For cleaning, the appliance must be switched off and cooled down.
- For safety reasons, the cleaning of the appliance with steam jet or high-pressure cleaning equipment is not permitted.
- Always allow the hob to cool down and switch off the electrical supply before carrying out any cleaning or maintenance work.

Service

- This hob should only be repaired or serviced by an authorised Service Engineer and only genuine approved spare parts should be used.



Environmental Information

- After installation, please dispose of the packaging with due regard to safety and the environment.
- When disposing of an old appliance, make it unusable, by cutting off the cable. Remove any door catches, to prevent small children being trapped inside.
- The symbol  on the product or on its packaging indicates that this product should not be treated as normal household waste. Instead it shall be handed over to an approved collection facility for the recycling of electrical and electronic equipment. By ensuring this product is disposed of correctly, you will help prevent potential negative consequences for the environment and human health, which could otherwise be caused by inappropriate waste handling of this product. For more detailed information about recycling of this product, please contact your local city office, your household waste disposal service or the shop where you purchased the product.

Contents

For the User

Important Safety Information	2
Description of the Appliance	4
The control panel	11
· Touch Control sensor fields	11
· Displays	11
· Residual heat indicator	12
· Switching the appliance on and off	12
· Selecting the heat setting	12
· Locking/unlocking the control panel	12
· Using the child safety device	13
· Switching the power function on and off	14
· Using the timer	15
· Selecting a cooking zone	15
· Safety cut-out	17
When the hob is first installed	18
Hints and Tips on Cooking and Frying	19
· Cookware for induction cooking zones	19
· Tips on energy saving	19
Cooking chart	20
Maintenance and Cleaning	21
· Cleaning the appliance after each use	21
· Removing deposits	21
Something Not Working	22
Repairs - After Sales Service	23
Spare parts	23
· Rating Plate	23

For the Installer

Installation	5
· Technical Specifications	5
· Electrical Connection	6
· Electrical Requirements	6
Building In	7

Guide to use the Instruction Manual

The following symbols will be found in the text to guide you throughout the Instructions:



Safety Instructions



Hints and Tips



Environmental Information



This appliance complies with the following E.E.C. Directives:

- * **73/23 or 19.2.73 (Low Voltage Directive) and subsequent modifications;**
- * **89/336 or 3.5.89 (Electromagnetic Compatibility Directive) and subsequent modifications.**

Description of the Appliance

Cooking surface layout

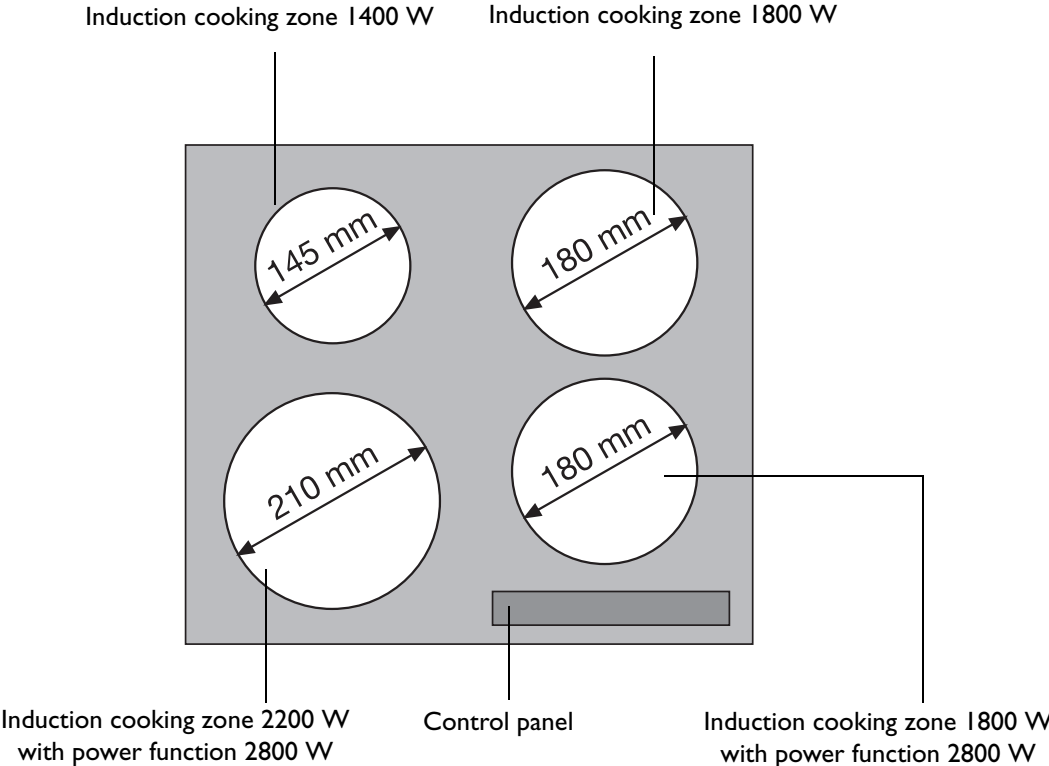

Installation



It is dangerous to alter the specifications or attempt to modify this product in any way.



Care must be taken to ensure that the appliance does not stand on the electrical supply cable.



Any electrical work required to install this appliance should be carried out by a qualified electrician or competent person.

Technical Specifications

Appliance dimensions	Width Depth Height	590 mm 520 mm 55 mm
Worktop cut-out dimensions	Width Depth	560 mm 490 mm
Connection voltage	230 V ~ 50Hz	
Maximum connected load power	7,2 kW	

Cooking rings

Position	Diameter	Power
Front left	210 mm	2800 W
Rear left	140 mm	1400 W
Rear right	180 mm	1800 W
Front right	180 mm	2800 W

Electrical Connection



This hob must be earthed.

Electrical Requirements

Any permanent electrical installation must comply with the latest I.E.E. Regulations and local Electricity Board regulations. For your own safety this should be undertaken by a qualified electrician, e.g. your local Electricity Board, or a contractor who is on the roll of the National Inspection Council for Electrical Installation Contracting (NICEIC).

Electrical Connection

The hob is designed to be connected to 230 V (50 Hz) electricity supply. Before connecting to the mains supply ensure that the mains voltage corresponds to the voltage on the rating plate underneath the hob.

For UK only

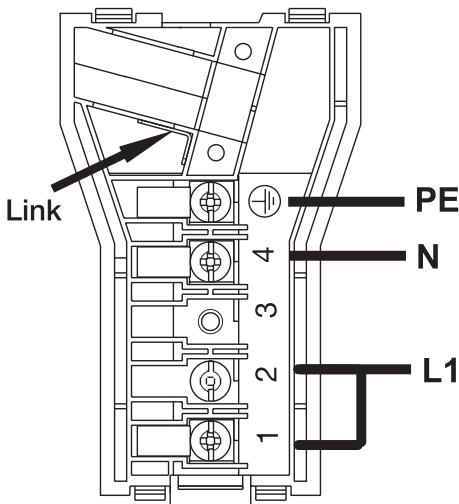

It is necessary that you install a double pole switch between the hob and the electricity supply (mains), with a minimum gap of 3 mm between the switch contacts and of a type suitable for the required load in compliance with the current rules.



The switch must not break the yellow and green earth cable at any point.

It is necessary that the yellow / green earth wire is about 2 cm longer than the live and neutral ones.

Important

After installation and connecting, the cable must be placed so that it cannot at any point reach a temperature of more than 60°C above the ambient temperature.

Before the hob is connected, check that the main fuse and the domestic installation can support the load; and that the power supply is properly earthed.

The manufacturer disclaims any responsibility should these safety measures not be carried out.

Building In

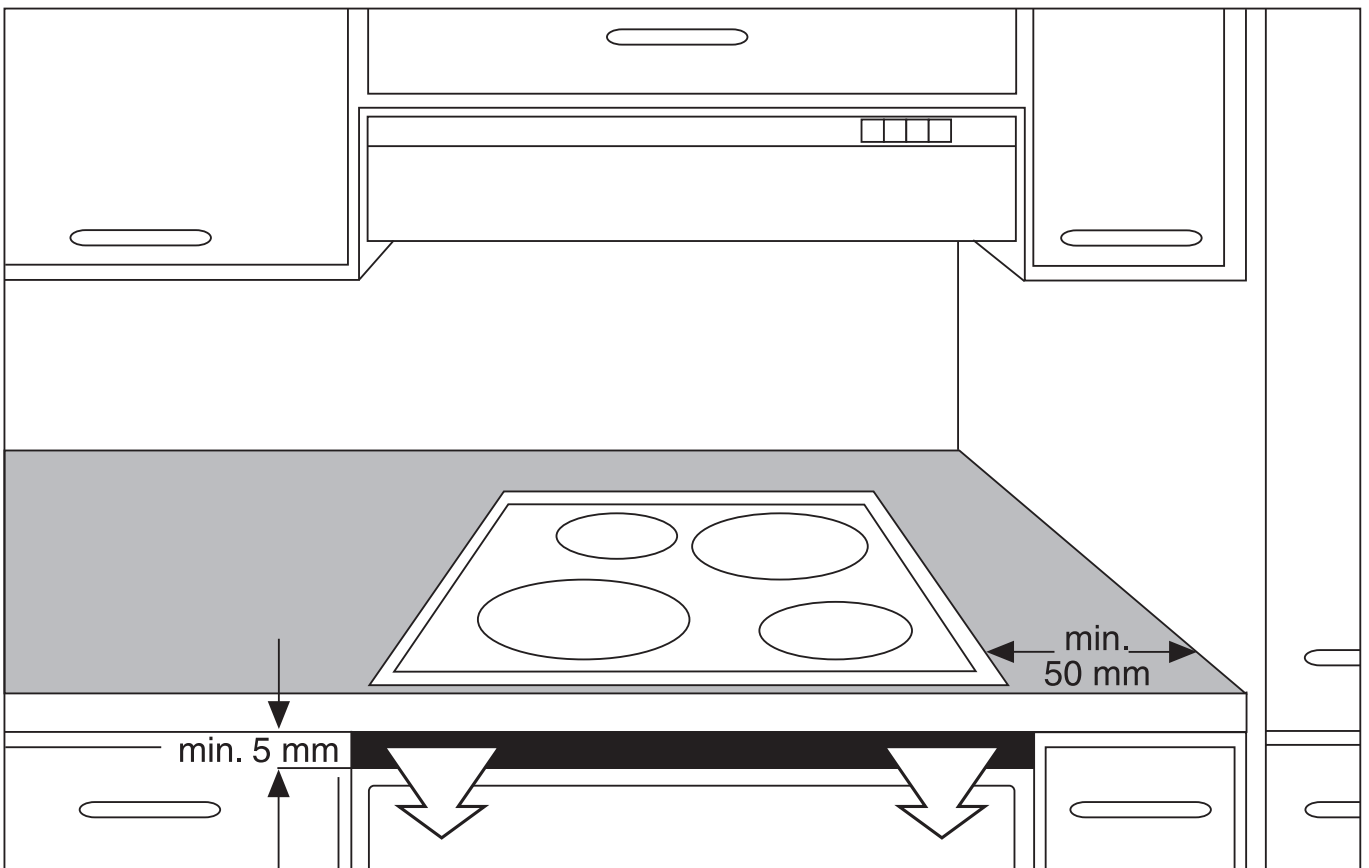
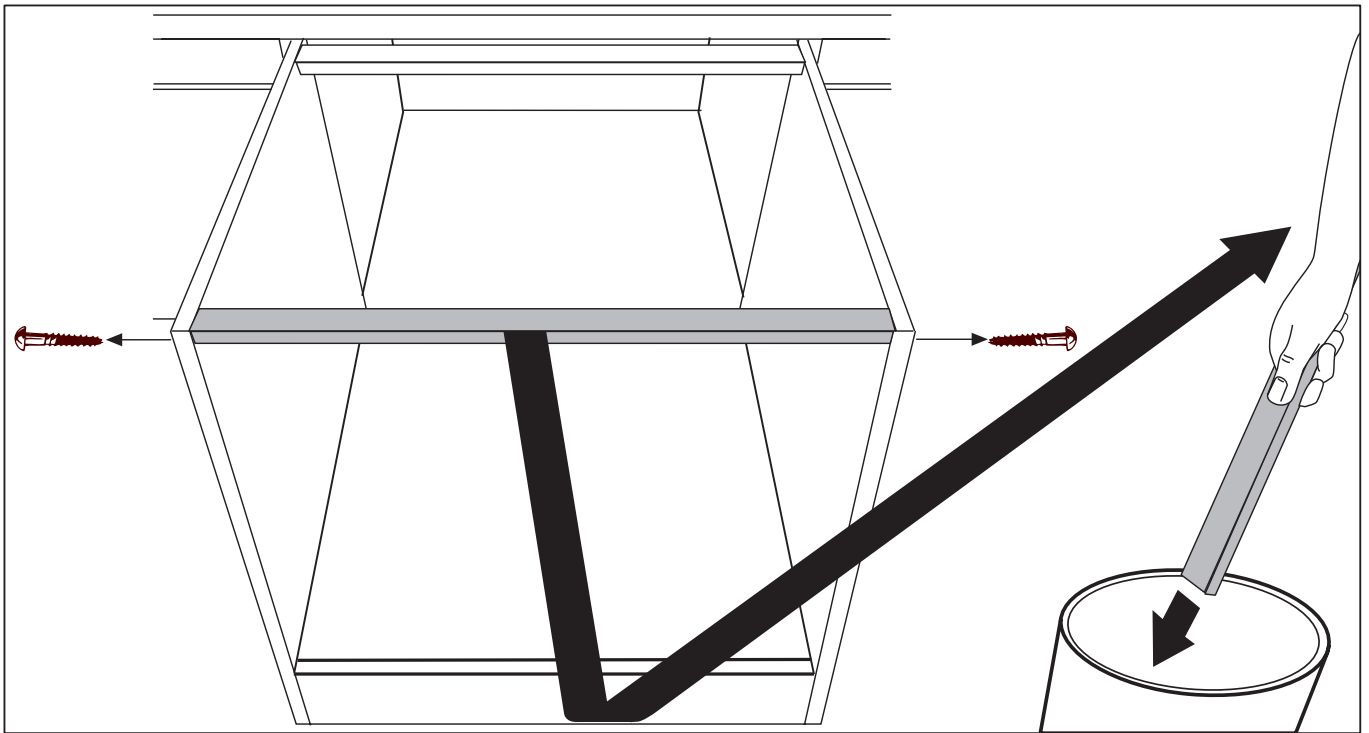

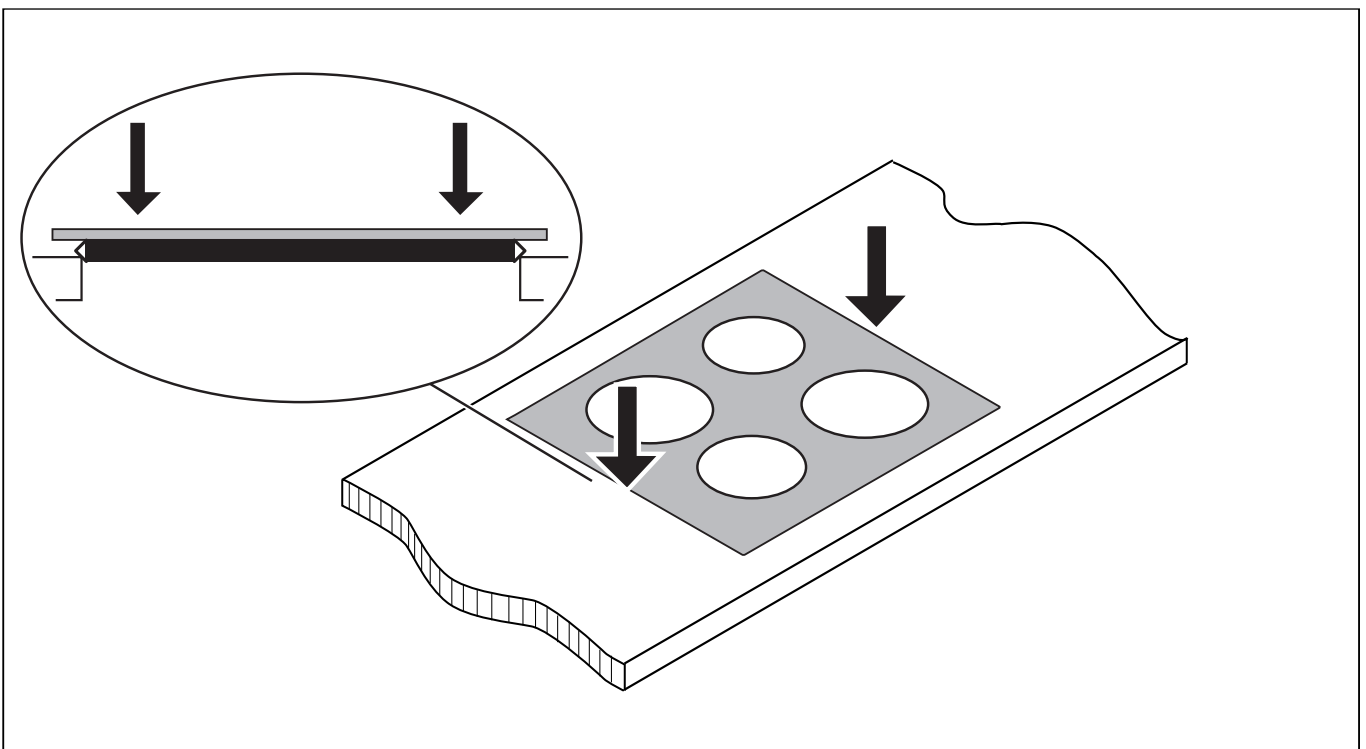
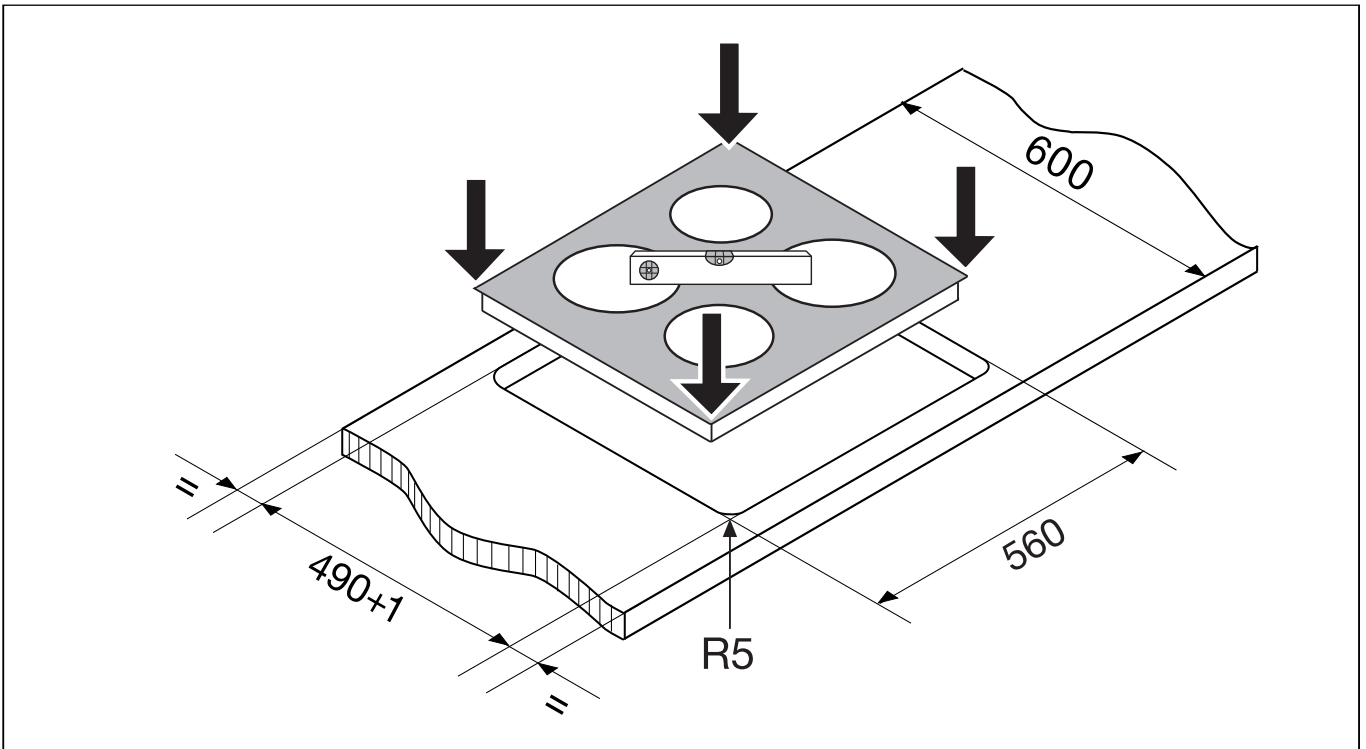
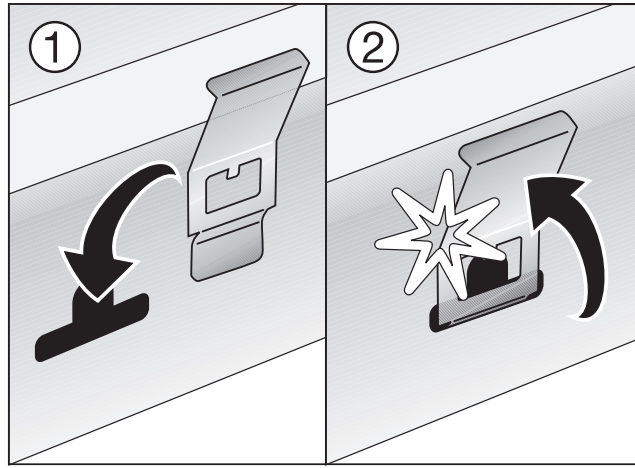

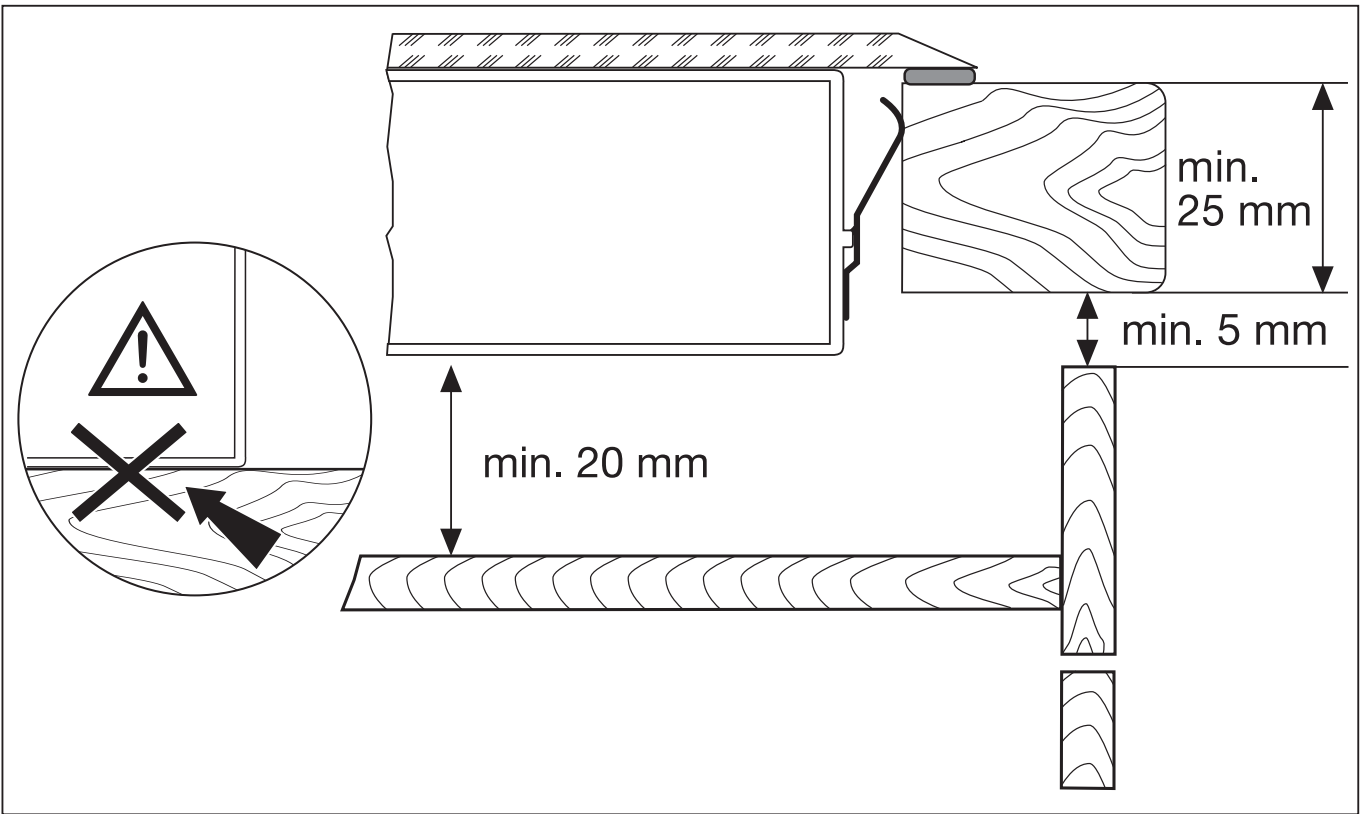
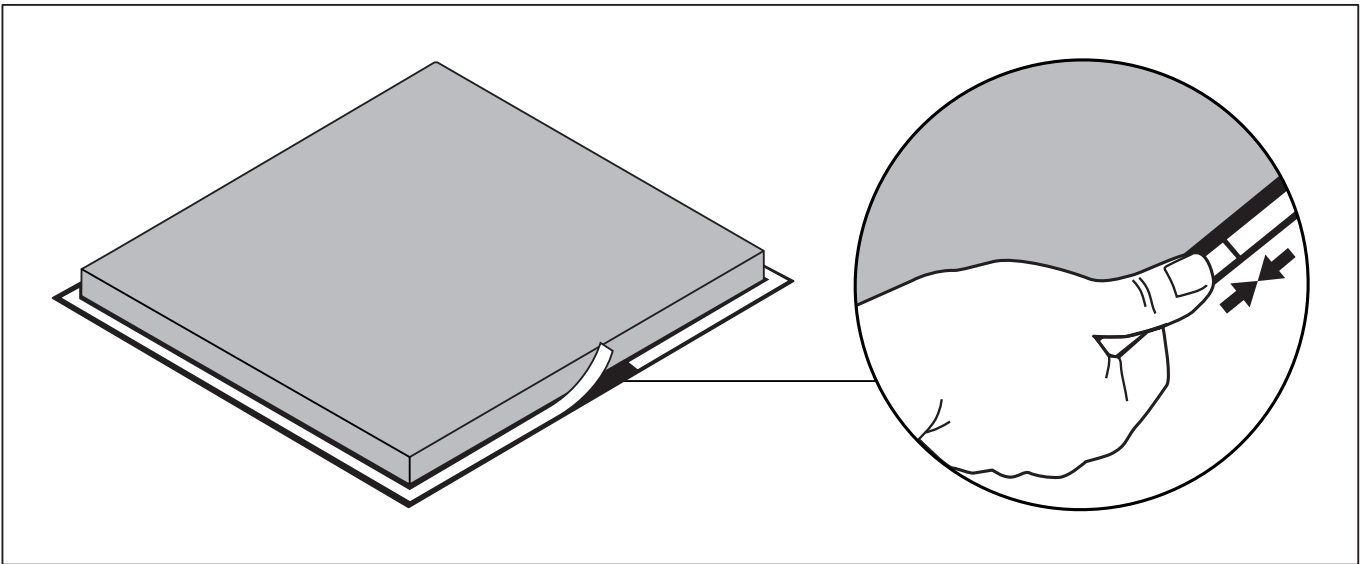

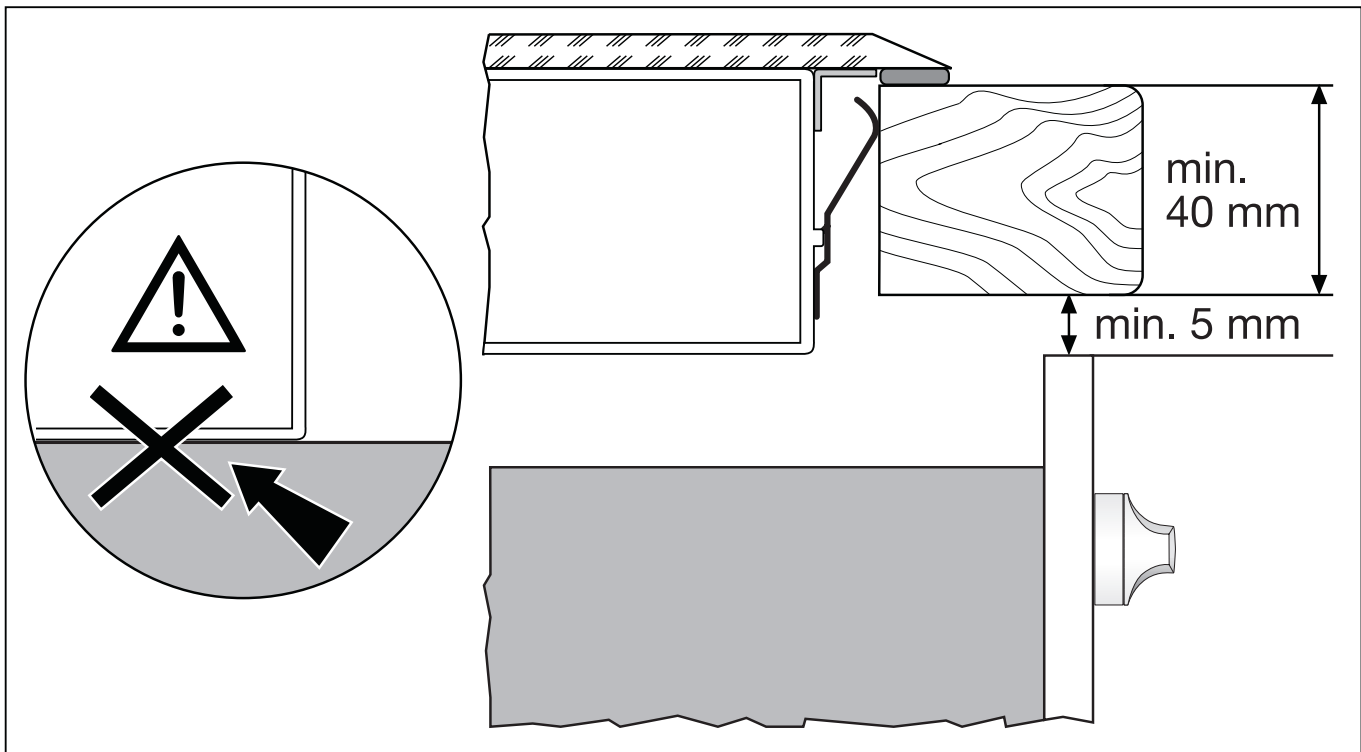

The control panel

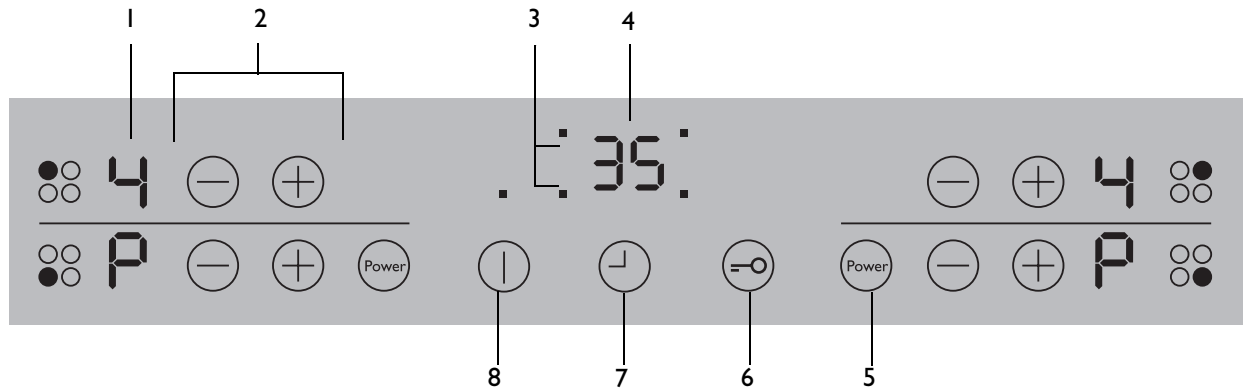

- 1: Display
- 2: Heat setting selection
- 3: Cooking zone indicators Timer function
- 4: Timer display
- 5: Power function
- 6: Lock
- 7: Timer
- 8: On/Off with power indicator

Touch Control sensor fields

The appliance is operated using Touch Control sensor fields. Functions are controlled by touching sensor fields and confirmed by displays and acoustic signals.



Touch the sensor fields from above, without covering other sensor fields.

Sensor field		Function
⏻	On / Off	Switches appliance on and off
+	Increase settings	Increasing heat setting/time
-	Decrease settings	Decreasing heat setting/time
⌚	Timer	Timer selection
🔒	Lock	Locking/unlocking the control panel
⚡	Power	Switching the power function on and off

Displays

Display	Description
⏻	Cooking zone is switched off
1 - 9	Heat settings
E	Fault
F	Pan detection
H	Residual heat
L	Child safety device
P	Power
-	Safety cut-out

Residual heat indicator

 **Warning!** Risk of burns from residual heat. After being switched off, the cooking zones need some time to cool down. Look at the residual heat indicator .





 Residual heat can be used for melting and keeping food warm.

The **induction cooking zones** create the heat required for cooking directly in the base of the cookware. The glass ceramic is merely heated by the residual heat of the cookware.

The **cooling fan** switches itself on and off depending upon the temperature of the electronics.











 Use the induction cooking zones with suitable cookware.

Switching the appliance on and off

	Control panel	Display	Pilot light
Switch on	Touch  for 2 seconds	 / 	lights up
Switch off	Touch  for 1 second	 / none	goes out



 After switching on, within approx. 10 seconds a heat setting or a function must be set, otherwise the appliance automatically switches itself off.

Selecting the heat setting

	Control panel	Display
Increase	Touch 	 to  / 
Decrease	Touch 	 to 
Switch off	Touch  and  at the same time	

Locking/unlocking the control panel

The control panel, with the exception of the “On/Off” sensor field, can be locked at any time in order to prevent the settings being changed e.g. by wiping over the panel with a cloth.





	Control panel	Display
Switch on	Touch 	 (for 5 seconds)
Switch off	Touch 	previously set heat setting

 When you switch the appliance off, the locking function is automatically switched off.

Using the child safety device

The child safety device prevents unintentional use of the appliance.





Setting the child safety device

Step	Control panel	Display/Signal
1.	① Switch on the appliance (Do not set a heat setting)	
2.	Touch  until the signal sounds	Acoustic signal
3.	Touch 	

Appliance switches off. The child safety device is set.



Overriding the child safety device

The child safety device can be released in this way for a single cooking session; it remains activated afterwards.

Step	Control panel	Display/Signal
1.	① Switch on the appliance	
2.	Touch  and  at the same time	 / acoustic signal

Until the appliance is next switched off, it can be used as normal.

Releasing the child safety device



Step	Control panel	Display/Signal
1.	① Switch on the appliance	
2.	Touch  until the signal sounds	Acoustic signal
3.	Touch 	

Appliance switches off. The child safety device is released.

Switching the power function on and off

The power function  makes additional power available to the front induction cooking zones, e.g. to bring a large volume of water to the boil.

The power function is activated for 8 minutes for the front left cooking zone and for 5 minutes for the front right cooking zone. After these times, the induction cooking zones automatically return to cooking level .

	Control panel	Display
Switch on	Touch 	
Switch off	Touch 	
	Touch 	

 If the power function has ended, the cooking zones automatically switch back to the heat setting set previously.

Power Management





The cooking zones have a maximum power available to them.

If this power range is exceeded by switching on the power function, Power Management reduces the heat setting of another cooking zone.

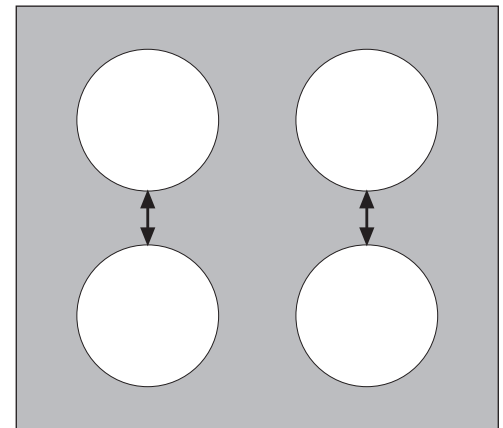
The indicator for this cooking zone changes between the heat setting set and maximum possible heat setting for one minute. Thereafter the actual heat setting is displayed.

Example:



Last cooking zone switched on	Other cooking zone		
	set heat setting	indicator	actual heat setting
		 alternating with 	

Using the timer









All cooking zones can use each use one of the two timer functions at the same time.

Function	Condition	Outcome after the time has elapsed
Automatic cut-out	a heat setting is set	acoustic signal 00 flashes Cooking zone switches off
Countdown timer	cooking zones not in use	acoustic signal 00 flashes

i If a cooking zone is switched off, the timer function set is also switched off.

i If a heat setting is set on this cooking zone in addition to a countdown timer, the cooking zone is switched off after the time set has elapsed.

Selecting a cooking zone

Step	Control panel	Display
1.	Touch  once	Pilot light of the first cooking zone flashes 
2.	Touch  once	Pilot light of the second cooking zone flashes 
3.	Touch  once	Pilot light of the third cooking zone flashes 
4.	Touch  once	Pilot light of the fourth cooking zone flashes 

i The heat setting indicator of the selected cooking zone goes out, as long as the timer time can be set.

i If the pilot light is flashing more slowly, the heat setting indicator appears again and the heat setting can be re-set or modified.

i If other timer functions are set, after a few seconds the shortest remaining time of all the timer functions is displayed and the corresponding pilot light flashes.

Setting time

Step	Control panel	Grill setting
1.	⏵ Selecting cooking zone	Telltale of cooking zone selected flashes
2.	Touch ⊕ or ⊖ from the selected cooking zone	01 to 99 minutes
3.	Touch ⊕ or ⊖ from the selected cooking zone for more than 4 seconds	... 05... 10... 15... 20 or... 95... 90... 85... 80... (5-minute steps for easy setting)

After a few seconds the power indicator flashes more slowly.

The time is set.

The time counts down.

Switching off the Timer function

Step	Control panel	Display
1.	⏵ Select a cooking zone	Pilot light of the selected cooking zone flashes more quickly. Remaining time is displayed
2.	Touch ⊖ for the cooking zone selected	The remaining time counts down to 00.

The pilot light goes out.

The Timer function for the selected cooking zone is switched off.

Changing the time

Step	Control panel field	Display
1.	⏵ Select cooking zone	Pilot light of the cooking zone selected flashes faster The time remaining is displayed
2.	Touch ⊕ or ⊖ for the cooking zone selected	01 to 99 minutes

After a few seconds the pilot light flashes more slowly.

The time is set.

The time counts down.

Displaying the time remaining for a cooking zone

Step	Control panel field	Display
1.	⏵ Select cooking zone	Pilot light of the cooking zone selected flashes faster The time remaining is displayed

After a few seconds the pilot light flashes more slowly.

Switching off the acoustic signal

Step	Control panel field	Acoustic signal
1.	Touch ⏵	Acoustic signal to acknowledge.

Acoustic signal stops.

Safety cut-out





Cooking surface

- If after switching on the cooking surface, a heat setting is not set for a cooking zone within approx. 10 seconds, the cooking surface automatically switches itself off.
- If all cooking zones are switched off, the cooking surface automatically switches itself off after approx. 10 seconds.

Control panel

 Moisture (e.g. a wet cloth) or liquid boiling over onto the control panel immediately switches all cooking zones off.

Induction cooking zones

- In the case of overheating (e.g. when a saucepan boils dry) the cooking zone automatically switches itself off.  is displayed. Before being used again the cooking zone must be set to  and allowed to cool.
- If cookware that is not suitable is used,  lights up in the display and after 2 minutes the display for the cooking zone switches itself off.
- If one of the cooking zones is not switched off after a certain time, or if the heat setting is not modified, the relevant cooking zone switches off automatically.  is displayed. Before being used again, the cooking zone must be set to .

Heat setting	Switches off after
1 - 2	6 hours
3 - 4	5 hours
5	4 hours
6 - 9	1.5 hours

When the hob is first installed



Remove all packaging, both inside and outside the hob including the advertising labels and any protective film, before using the hob.



When a cooking zone is switched on, it may hum briefly. This is a characteristic of all ceramic glass cooking zones and does not impair either the function or the life of the appliance.

Hints and Tips on Cooking and Frying



Information about acrylamides

According to the latest scientific research, intensive browning of food, especially in products containing starch, may present a health risk due to acrylamide. Therefore we recommend cooking at low temperatures and not browning foods too much.

Cookware for induction cooking zones

Cookware material

Cookware material	Suitable
Steel, enamelled steel	yes
Cast iron	yes
Stainless steel	if appropriately labelled by the manufacturer
Aluminium, copper, brass	---
Glass, ceramic, porcelain	---



Cookware for induction cooking zones is labelled as suitable by the manufacturer.

Suitability test

Cookware is suitable for induction cooking, if ...

- ... a little water on an induction cooking zone set to heat setting 9 is heated within a short time.
- ... a magnet sticks to the bottom of the cookware.



Certain cookware can make noises when being used on induction cooking zones. These noises are not a fault in the appliance and do not affect operation in any way.

Bottom of the cookware

The bottom of the cookware should be as thick and flat as possible.

Pan size

Induction cooking zones adapt automatically to the size of the bottom of the cookware up to a certain limit. However the magnetic part of the bottom of the cookware must have a minimum diameter depending upon the size of the cooking zone.

Diameter of cooking zone [mm]	Minimum diameter of dish base [mm]
210	180
180	145
145	120



The cookware must be placed centrally on the cooking zone.

Tips on energy saving



Place cookware on the cooking zone before it is switched on.



If possible, always place a lid on the cookware.

Cooking chart

i This chart is intended as a guide only. It may be necessary to increase or decrease the temperature to suit your individual requirements. Only experience will enable you to determine the correct setting for your personal requirements.

Heat setting	Cooking process	suitable for	Cook time	Tips/Hints
0		Off position		
1	Keeping food warm	Keeping cooked foods warm	as required	Cover
1-2	Melting	Hollandaise sauce, melting butter, chocolate, gelatine	5-25 mins.	Stir occasionally
	Solidifying	Fluffy omelettes, baked eggs	10-40 mins.	Cook with lid on
2-3	Simmering	Simmering rice and milk-based dishes Heating up ready-cooked meals	25-50 mins.	Add at least twice as much liquid as rice, stir milk dishes part way through cooking
3-4	Steaming Braising	Steaming vegetables, fish Braising meat	20-45 mins.	With vegetables add only a little liquid (a few tablespoons)
4-5	Boiling	Steaming potatoes	20-60 mins.	Use only a little liquid, e. g.: max. ¼ l water for 750 g of potatoes
		Cooking larger quantities of food, stews and soups	60-150 mins.	Up to 3 l liquid plus ingredients
6-7	Gentle frying	Frying escalope, veal cordon bleu, cutlets, rissoles, sausages, liver, roux, eggs, pancakes, doughnuts	as required	Turn halfway through cooking
7-8	Heavy frying	Hash browns, loin steaks, steaks, Flädle (pancakes for garnishing soup)	5-15 mins. per pan	Turn halfway through cooking
9	Boiling Searing Deep frying	Boiling large quantities of water, cooking pasta, searing meat (goulash, pot roast), deep frying chips		

The power function is suitable for heating large quantities of liquid.

Maintenance and Cleaning



Warning! Risk of burns from residual heat.



Important Sharp objects and abrasive cleaning materials will damage the appliance. Clean with water and washing up liquid.



Important Residues from cleaning agents will damage the appliance. Remove residues with water and washing up liquid.

Cleaning the appliance after each use

1. Wipe the appliance with a damp cloth and a little washing up liquid.
2. Rub the appliance dry using a clean cloth.

Removing deposits

1. Place the scraper on the glass ceramic surface at an angle.
2. Remove residues by sliding the blade over the surface.
3. Wipe the appliance with a damp cloth and a little washing up liquid.
4. Rub the appliance dry using a clean cloth.

Type of dirt	Remove		
	immediately	when the appliance has cooled down	using
sugar, food containing sugar	yes	---	a scraper*
plastics, tin foil	yes	---	
limescale and water rings	---	yes	cleaner for glass ceramic or stainless steel*
fat splashes	---	yes	
shiny metallic discolorations	---	yes	

*Scrapers and cleaners for glass ceramic and stainless steel can be purchased from your local John Lewis branch.



Remove stubborn residues with a cleaner for glass ceramic or stainless steel.









Scratches or dark stains on the glass ceramic that cannot be removed do not affect the functioning of the appliance.

Something Not Working

If the hob is not working correctly, please carry out the following checks, before contacting your local Service Force repair agent.

In the event of any other fault codes that arise, disconnect the appliance from the electrical supply for a few seconds (take out the fuse from the housing wiring system). If the fault code is displayed again, please call your local Service Force repair agent and report the fault code.

IMPORTANT: If you call out an engineer to a fault listed below, or to repair a fault caused by incorrect use or installation, a charge will be made even if the appliance is under guarantee.

Problem	Possible cause	Solutions
The appliance cannot be switched on or is not operating	More than 10 seconds have passed since the appliance was switched on	Switch the appliance on again.
	The lock is switched on 	Switch off the lock (See the section "Locking/unlocking the control panel")
	The child safety device is switched on 	Deactivate child safety device (See the section "Child safety device")
	Several sensor fields were touched at the same time	Only touch one sensor field
	Safety cut-out has been triggered	Remove any objects (pan, cloths, etc.) that are lying on the control panel. Switch the appliance on again
The cooking zones automatically reduce the cooking level to 	The sensor fields are partly covered by a damp cloth or with liquid	Remove the cloth or the liquid. Reset the cooking level required.
The residual heat indicator is not displaying anything	The cooking zone was only on for a short time and is therefore not hot	If the cooking zone is supposed to be hot, call your local Service Force Centre.
acoustic signal sounds, appliance switches off	One or more sensor fields have been covered for longer than 10 seconds	Uncover sensor field
Acoustic signal sounds and appliance switches itself on and after 10 seconds off again	The On/Off sensor field has been covered up, e.g. by a cloth	Do not place any objects on the control panel
Display is switching between two heat settings	Power management is reducing the power of this cooking zone	See the section "Switching the power function on and off"
 is lit	Unsuitable cookware	Use suitable cookware
	No cookware on the cooking zone	Put cookware on zone
	Diameter of the base of the cookware is too small for the cooking zone	Move to smaller cooking zone Use suitable cookware
 is lit	Overheating protection for the cooking zone has been triggered	Switch off the cooking zone. Switch the cooking zone on again
	Safety cut-out has been triggered	Switch off the cooking zone. Switch the cooking zone on again
 and number are displayed	Electronics fault	Disconnect the appliance from the electrical supply for a few minutes (Take the fuse out of the house's wiring system) If after switching on again,  is displayed again, call the customer service department

Repairs - After Sales Service

If your hob is not performing satisfactorily; consult the fault finding guides within this instruction book (Something not working). If a fault occurs which you can not resolve through following the advice and information contained within this instruction manual, the next step is to contact our extended warranty administrators on

0870 0107887

They will give you details for your local Service Force Centre.

Before calling out an engineer, please ensure you have read the details under the heading "Something Not Working".

When you contact your local Service Force Centre you will need to give the following details:

1. Your name, address and post code
2. Your telephone number
3. Clear and concise details of fault
4. The purchase date and found on your receipt.
5. The model and serial number of the appliance (found on the rating plate located underneath the hob, see picture on this side).

So that you always have these numbers at hand, we recommend you to make a note of them here:

Mod. :

PNC :

S.N. :

Your hob is covered by a 3 year parts and labour guarantee (see separate details given at point of sale). Please retain your purchase receipt safely for the service engineer to verify the purchase details.

Spare parts

This product should be serviced by any authorised service engineer; and only genuine spare parts should be used.

Under no circumstances should you attempt to repair the hob yourself.

Repairs carried out by inexperienced persons may cause injury or serious malfunctioning. Contact our extended warranty administrators on

0870 0107887

who will give you details for your Service Force repair agent. Always insist on genuine spare parts.

Rating Plate

Modell JLBIIH603		Prod.Nr. 949 592 582	
Typ 55GADD5AU	230 V	50 Hz	Induction 7,2 kW
Made in Germany	Ser.Nr.	7,2 kW	
John Lewis			

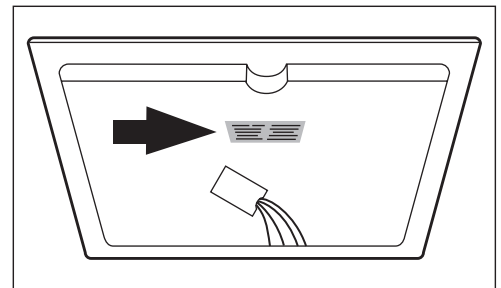

John Lewis Partnership

171 Victoria Street

London SW1E 5NN

www.johnlewis.com