

# BENDIX

autowasher electronic 1000

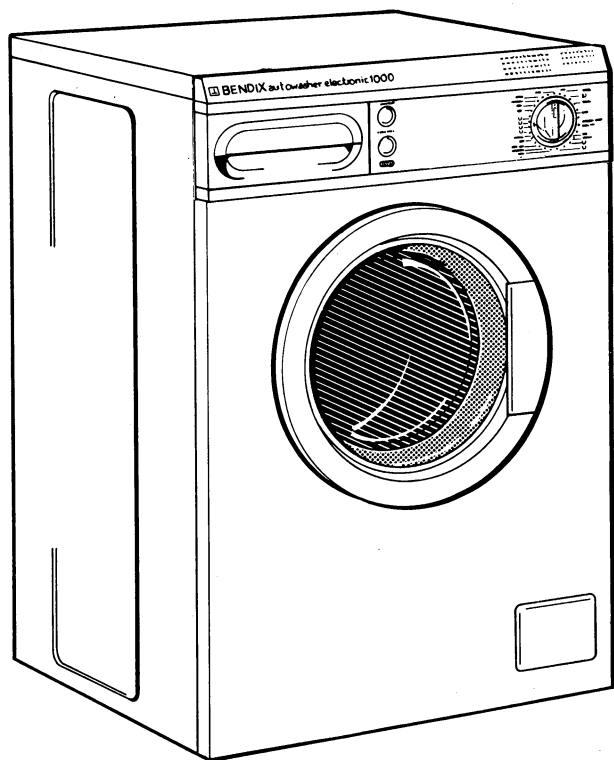

model 71378

operating and installation instructions



# **BENDIX autowasher electronic 1000 Model 71378**

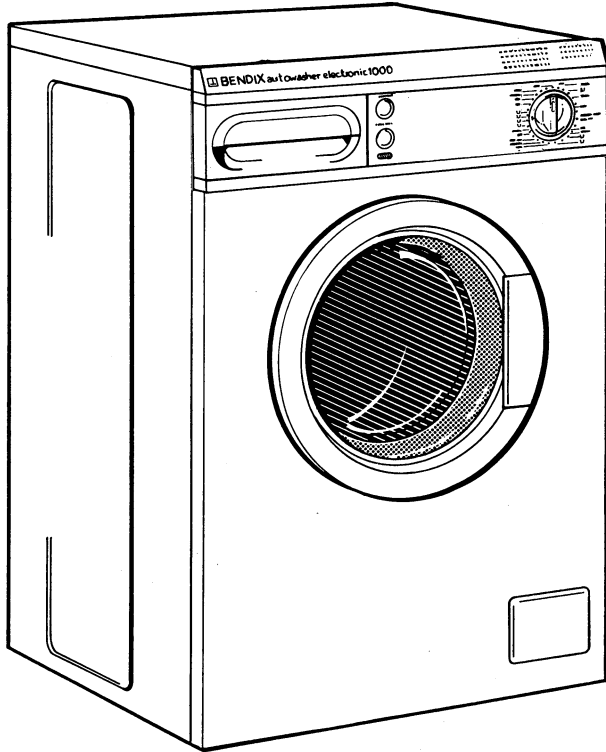

You are now the proud owner of a Bendix Autowasher electronic, you will be pleased to find that it washes, rinses and spins without you having to handle the clothes in between times.

You will obviously want to obtain the best possible wash. By reading and following the instructions in this booklet you will achieve excellent results.

Please ensure that the Installation Instructions are followed.

If you should need any further advice or assistance please contact the Bendix agent from whom your machine was purchased or your nearest THORN Customer Service Centre.

# BENDIX

## Installation and Operating Instructions

# Model 71378

## Autowasher electronic 1000

### DIMENSIONS

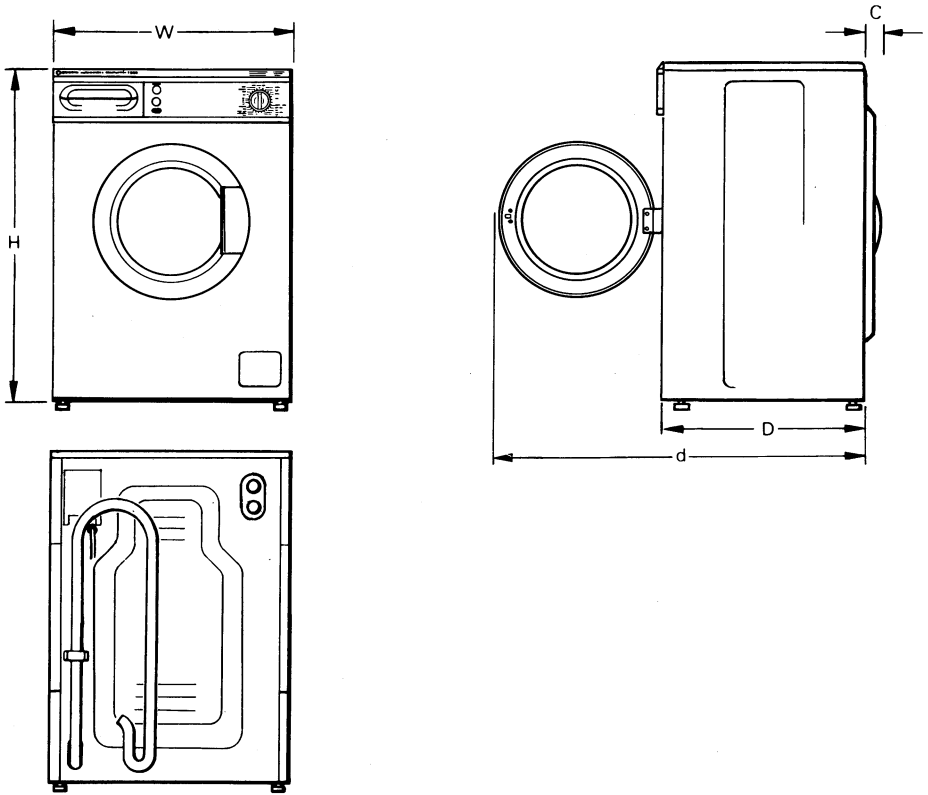

Height, overall (H)	850 mm	33½ in
Width (W)	595 mm	23½ in
Depth - door closed (D)	520 mm	20½ in
- door open (d)	910 mm	35¾ in

Rear projection (C)	50 mm	2 in
Weight - empty	87 kg	192 lb

Electrical loadings:	
Heater	2.5 kW
Motor - tumble	350W
- spin	400W & 800W

Drain Pump	95W
------------	-----

## SITE REQUIREMENTS

A dry, level, and a relatively smooth floor, with the services brought to the appliance. A minimum of 12 mm (1/2 in) clearance is required each side of the appliance.

## UNPACKING & INSTALLATION

Remove the box protective packing and polystyrene base. Remove back panel screws and lift panel clear. Using the spanner provided, remove the four internal transit straps as shown in the diagram below, together with

the three chassis bracing straps and store in a convenient place together with the fixing bolts and washers.

Insert the four plastic plugs provided into the four bolt holes vacated by the transit fixing bolts in the back panel.

Relocate and fix the back panel.

Always refit the transit brackets before transporting the appliance.

Connect the hoses, making sure that the sealing washers 'x' are in place. Some hoses now incorporate the sealing washers 'x' into the connections.

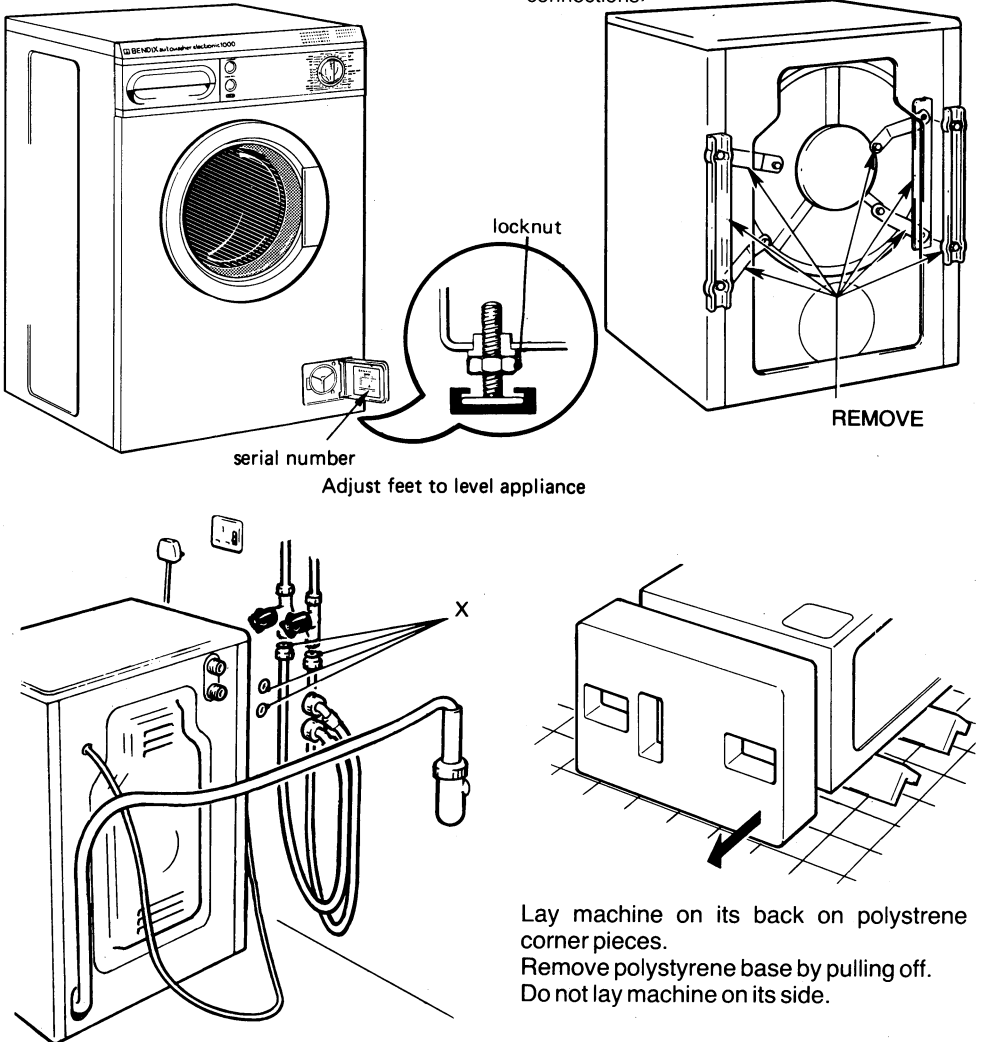

## ELECTRICITY

Fused and earthed supply: 240V 50Hz a.c.

Mains lead: 3 core 2.7 m 9ft

Fuse ratings: 13A

### CONNECTING THE ELECTRICITY

Before switching on make sure that the voltage of your electricity supply is the same as that indicated on the rating plate.

#### WARNING:

#### THIS APPLIANCE MUST BE EARTHED

If this appliance is fitted with a non-rewireable plug for which your socket is unsuitable the plug should be cut off and an appropriate plug fitted. The removed plug should be disposed of as insertion of the plug into a 13 amp socket is likely to cause an electrical hazard.

**IMPORTANT**- The wires in the mains lead are coloured in accordance with the following code:

GREEN AND YELLOW	EARTH
BLUE	NEUTRAL
BROWN	LIVE

As the colours of the wires in the mains lead of this appliance may not correspond with the colour markings identifying the terminals in your plug proceed as follows:

The wire which is coloured green and yellow must be connected to the terminal which is marked with the letter 'E' or by the 'Earth' symbol  $\equiv$  or coloured green or coloured green and yellow.

The wire which is coloured blue must be connected to the terminal which is marked with the letter 'N' or colour black. The wire which is coloured brown must be connected to the terminal which is marked with the letter 'L' or coloured red.

The appliance must be protected by a 13 amp ASTA approved (BS1362) fuse if a 13 amp (BS1363) plug or a non-rewireable plug is used. If any other type of plug is used, a 15 amp fuse either in the plug or adaptor or at the distribution board.

If it is necessary to change the fuse in a non-rewireable plug the fuse cover must be refitted. If the fuse cover is lost or damaged the plug must not be used until a replacement is obtained. Replacement fuse covers are available from THORN Customer Parts Centre, Angel Road, Edmonton, London N18 3HL. It is important that the colour of the replacement fuse cover corresponds with the colour marking on the base of the plug.

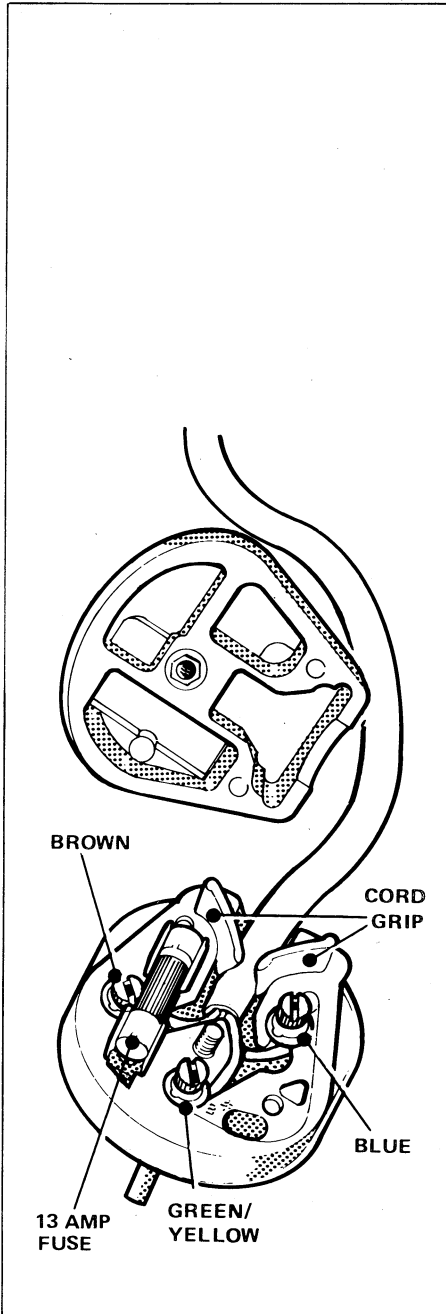

## WATER

Supply: Hot & Cold, or Cold-only, using 'F' connector 25115.

Pressure - maximum	1000 kN/m <sup>2</sup>	140 lb/in <sup>2</sup>
- minimum	25 kN/m <sup>2</sup>	3.5 lb/in <sup>2</sup>
Temperature: Hot water	60°C maximum	
Inlet connection	¾ BSP	¾ BSP
Inlet hose length	1.5 m	5 ft
Inlet height HS2	810 mm	31 ⅞ in

Preferred stopcock position: left hand side  
300 mm 1 ft

Stopcock recommended:  
Bendix 24041 'Hot' & 24042 'Cold'

Head (Hd) maximum	100 m	330 ft
minimum	3.0 m	10 ft

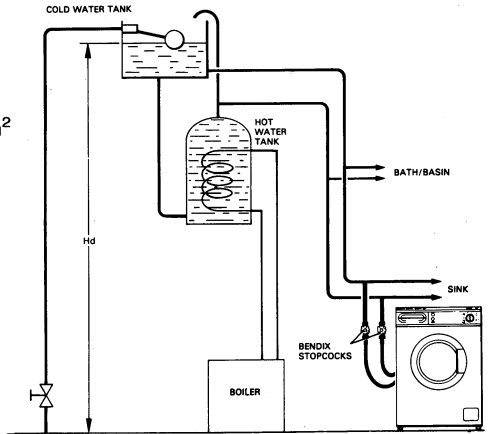

## CONNECTING TO THE WATER SUPPLY

The diagram shows a typical domestic plumbing system. Connections can be made by fitting tee-pieces in the existing pipework\*.

Permanent connections to Bendix stopcocks located at the lefthand side of the appliance are recommended. Ensure that they are positioned near enough to the appliance to permit it being moved for servicing.

Where necessary the appliance can be used on Cold-only water supply by connecting both water inlets by means of a Bendix F-connector 25115. Before using the new pipework for the first time flush out swarf and flax.

The grey hose supplied with the machine is marked '25°C maximum'. This should only be connected to the cold water supply. Always use for connection to the cold water supply by means of the F-connector.

## Instantaneous Water Heaters

This model is suitable for use with some makes of instantaneous gas water-heaters. Full details of compatible water-heaters should be obtained from the heater manufacturer or Gas showroom.

The use of these heaters may require more frequent cleaning of the Autowasher water inlet filters than would be necessary with other water heating methods.

## DRAINAGE

Length of drain hose	1.5 m	5 ft
Standpipe bore (B)	38-40 mm	1 1/2 in
Standpipe to floor (SH)		
- maximum	900 mm	36 in
- minimum	600 mm	24 in
Preferred minimum standpipe (S)		
	380 mm	15 in
Suggested trap*	Bottle type	Bottle type
Fall to drain (F)	100 mm/m	1 in/ft

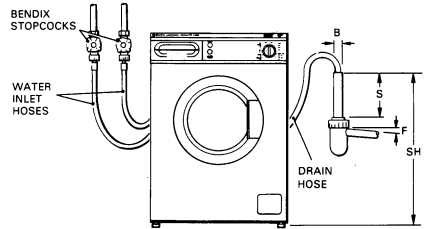

## CONNECTING THE DRAINAGE

### Important

Before using your machine for the first time ensure that the drain screen is fitted correctly. Failure to do so may result in a flood.

A standpipe is recommended, with the dimensions as above. If the appliance is to be left connected to the plumbing and drainage the moulded hook of the drain hose should be inserted in the standpipe.

The hose can also be hooked over the edge of a sink.

Permanent drainage arrangements should conform to the dimensions given. There must be an airbreak or the appliance may syphon.

The drain hose should not be pushed into the standpipe more than 200 mm (8 in)

## OPTIONAL EXTRAS

Optional fittings are available from your Bendix stockist and will ease the installation and use of the appliance:

Stopcocks:		Stacking Kits:	
'Hot'	24041	with pull-out shelf	28300
'Cold'	24042	without shelf	28301
Cold-fill F connector	25115		

The dimensions given in these instructions are not intended to be direct conversions between metric and imperial units. Please work in one set only.

\*The recommendations set out are suggestions only. All installations must comply with the requirements of local authorities or public utilities.

This appliance must be installed in accordance with the IEE regulations, in particular with regard to installation in bathrooms; if not we reserve the right to refuse to service it.

This appliance complies with European Economic Community Radio Interference Directive 82/499/EEC.



# Know your BENDIX autowasher electronic 1000

## **Mains On/Off Button**

Controls power to the machine.

## **Mains On Light**

Glowes to indicate the machine is energized.

## **Half Load Button**

This switch controls the water level thereby reducing the total water consumption, which in turn results in a saving of electricity and detergent. Select for small or medium loads. An indication of weights is given in the Wash Programme Guide.

When washing fabrics which are subject to creasing such as Acrilan, Orlon, Nylon, Terylene etc. load the cylinder no more than half full to allow plenty of room for the garments.

Do not use low water levels when washing woollens or silks.

## **Programme Selector Control**

Select the wash programme required according to the type of fabric and degree of soiling. Refer to the wash programme guide on the machine fascia or to the programme chart on page 12.

## **DETERGENT DISPENSER**

The detergent dispenser is so designed that detergents and additives will flush automatically into your machine. It is divided into three compartments 'A', 'B' and 'C'. Compartments A and B are used for detergents, Compartment C is used for additives, (see chart on page 12) fabric softeners such as Comfort. At the end of the wash programme, any remaining water will be automatically syphoned out leaving the dispenser ready for the next wash.

### **Note**

The detergent dispenser drawer and housing should be cleaned to prevent a build up of detergent and fabric softener. This dispenser drawer is easily removed by pulling out. Rinse it under the tap, dry and replace by inserting in the opening and pushing home.

## **Drain Screen**

The removable drain screen which protects the pump from lint and foreign matter needs to be

cleaned periodically. How often will depend on your wash load, e.g. cotton towels and nappies cause more lint to collect than nylon loads. Open the service door by pressing on the right hand side. Turn anticlockwise and pull the drain screen out. Have a cloth or shallow tray under the drain screen housing, as a small quantity of water may run out. You may find it helpful to first set the machine to spin then remove the drain screen. This procedure reduces the amount of water released. Clean the screen under running water to help remove any trapped lint. Replace the screen by sliding back into the housing. Lastly turn clockwise to secure.

Under no circumstances should the drain screen be removed whilst the machine is full of water.

## **Hoses**

Make sure that these are not kinked or the machine will not function correctly.

## **Adjustable Feet**

It is important that the machine is stable and level during operation. To help you obtain these conditions the machine is fitted with adjustable front feet.

To adjust the feet loosen the locking nuts using the spanner provided and adjust both feet to give a level and stable position and then retighten the locking nuts.

### **Note**

If the appliance is on an area which is carpeted, then we recommend the use of a piece of hardboard beneath the machine to help you locate the machine correctly in its final operating position.

## **Pre-fill**

### **Note**

At the start of the main wash, the machine will pre-fill. This means that initially water will flow into the machine through the detergent dispenser Compartment A. This will prevent detergent being flushed into the sump and wasted.

## **Pause**

### **Note**

This feature is incorporated in programmes 3, 4, 6, 7 and 8 so the clothes are held in the final rinse water. to complete the programme turn the Programme Selector to 'Spin'.

**DETERGENT DISPENSER  
DRAWER**

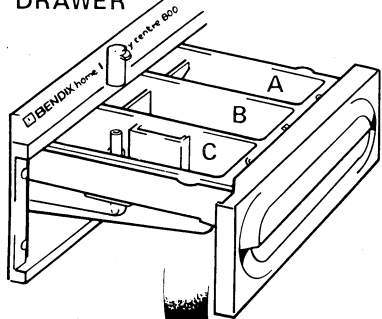

**HALF LOAD  
BUTTON**

**MAINS ON/OFF  
BUTTON**

**PROGRAMME  
SELECTOR**

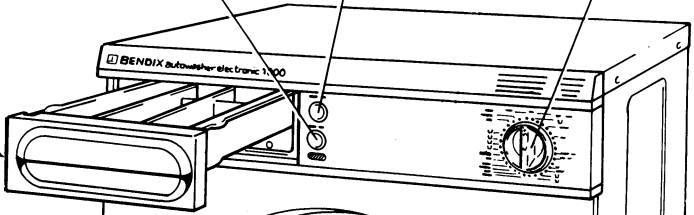

**HOT & COLD  
FILL HOSES**

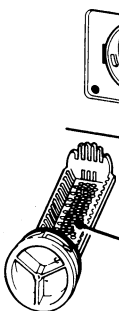
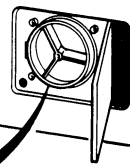
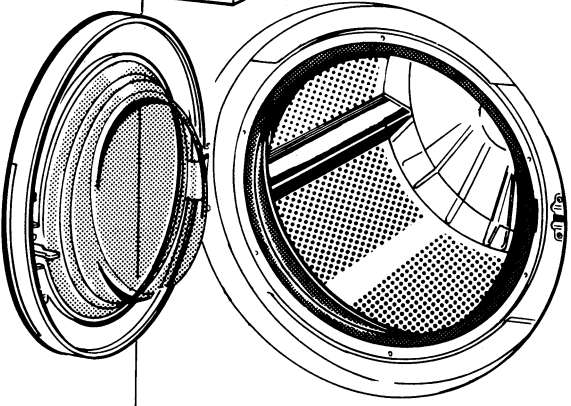
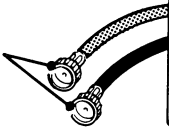

**DRAIN  
SCREEN**



**ADJUSTABLE  
FOOT**

# Using your BENDIX autowasher electronic 1000

Always use a low sudsing detergent like Persil Automatic in your machine as this is specially formulated to work in conjunction with the Autowasher electronic to give the best results.

Detergents will be flushed automatically into the machine from the detergent dispenser. The suds level should never rise more than halfway up the porthole. Too much foam will not only impede the wash action of your machine but may rise through the detergent dispenser, making a mess on the floor!

If this should happen clear excessive suds by setting the Wash Timer Dial/Programme Selector to the beginning of the first rinse setting, allow the machine to rinse out.

The following quantity of powder is a guide for average water supplies. If the water is very hard more powder may be needed. If very soft less will be needed. If you are in doubt refer to the instructions on the packet.

If you have a more heavily soiled load and decide to use the pre-wash before a main wash, use approximately one third of the powder in the pre-wash compartment of the dispenser and the remaining two thirds in the main wash compartment.

## Note

an average teacup holds (2½-3 oz) 75g-90g.

Half Load		Full Load	
Pre-wash	main-wash	Pre-wash	main-wash
(2 oz)	(3 oz)	(2½ oz)	5½ oz
60g	100g	75g	160g

On selected programmes water enters the machine and flows directly to the drum to ensure optimum use of detergent.

## Fabric Softeners e.g. Comfort

All fabrics, particularly towels and nappies, benefit from the use of fabric conditioner in the final rinse. Items of laundry feel softer, are more easily ironed and the clinging effect of static is considerably reduced.

## To Use

Pour the conditioner into the 'Additives' compartment 'C' of the detergent dispenser. Under no circumstances fill above the maximum level indicated as the conditioner will immediately be syphoned into the machine and a poor wash will result.

## Preparation Before You Wash

Today many garments carry a label under the International Textile Care Labelling Code (ITCLC) indicating the correct type of laundry treatment required. You will find that this label corresponds to the Wash Chart on page 12.

Sort your washing according to the Care Label number given on the garment, or if absent, according to the fabric and type of wash treatment required. Your Bendix takes up to 10 lb (4.5 kg) dry weight on clothes. See chart on page 12.

If you decide for one reason or another to mix fabrics, always use the wash programme for the most delicate fabric in the load. For example a wash load made up with fabrics from the wash groups 1/ and 2/ should be washed on 2/, similarly a wash load with fabrics from 3/ and 4/ should be washed on 4/ etc. White nylon, and delicate items i.e. programmes 3/, 4/, 6/, should be washed separately.

Make sure that the pockets have been emptied, zips fastened and apron strings tied. Remove pins and other small objects which could harm clothes if they become separated in the machine. If possible make up loads of similar soiling keeping heavily soiled items separate from lightly soiled clothes. Heavily soiled parts such as shirt cuffs and collars may be pre-treated by brushing with a solution of detergent and water; this should be applied lightly to the right side of the garment.

## Stain Removal

Most household stains come out in the normal wash but there are some which require special treatment. The following hints may help with common stains.

When using a stain remover or bleach follow the makers' direction carefully. Never use full strength bleach on any fabrics.

Rinse thoroughly after any special treatment. Chemicals left in fabrics can weaken or destroy some fibres. Test fabrics for possible damage to fibres or colour before tackling the stained area. For details on Stain Removal see page 13.

## Loading the Drum

When you have a large wash load made up of shirts, towels, pillowcases, pyjamas and other similar small items, pack them loosely into the drum.

Large items, a candlewick bedspread for instance, should be washed individually as an article as bulky as this will fill the drum on its own.

When washing a mixed load, put medium and small items into the cylinder alternately. A sheet should be picked up by the centre tentwise, shaken and then folded, pressing out the air.

## Programme Choice

The choice of programmes on your machine enables you to select the best wash programme for your load. The programmes on the Wash Timer Dial/Programme Selector correspond to the Care Labelling Code of the International Care labelling Scheme. see the chart on page 12.

## To Set a Wash Programme

1. Load the drum with clothes maximum dry weight 4.5 kg (10 lb) or 2 kg (4½ lb) synthetics. Close the door.
2. Select a programme - see chart on page 12.
3. Put the detergent and fabric conditioner into the dispenser (see chart page 12).
4. Press the on/off button to start the machine.

## Bio/Prewash

On more heavily soiled wash loads a Bio/Prewash will help to produce a better wash by loosening stains or soil ready for the main wash. Put sufficient low suds detergent (Bio low suds detergent may be used) into Section A of the soap dispenser as well as B, the Main Wash section. Select the pre-wash closest to the desired main wash programme. Once the 'On/Off' button has been pressed the machine will fill and heat the water to approximately 40°C whilst starting its reverse tumble wash action.

The Bio/Prewash takes approximately 17 minutes after which time the machine will automatically continue with the adjacent main wash programme.

The wash timer dial programme selector must be manually advanced to those programmes not adjacent to a pre-wash ie, [6], [7] and [8].

A Bio/Prewash should not be used prior to Programme [7] (Wool) as this may have an adverse effect on woollen items.

## Main Wash

To start the machine without a Bio/Prewash ensure that the Wash Timer Dial/Programme Selector is turned clockwise to the desired programme, (see chart) and the correct quantity of low suds detergent is in the main wash compartment of the detergent dispenser (see chart on page 12). Start the machine by pressing the on/off button.

## IMPORTANT

For programmes [6], [7] and [8] the detergent for Main Wash should be placed in compartment A.

## Woollens Wash

Your Bendix Autowasher Electronic 1000 has a programme for woollen articles which has been approved by the International Wool Secretariat (IWS) for machine washable articles. Select it by turning the Wash time Dial/Programme Selector to the programme [7].

Do not wash woollens in your Bendix unless the garment has been labelled 'machine washable'. This means that it has been specially treated to minimise shrinkage. However, it is advantageous to spin woollen articles that have been washed and rinsed by hand as this removes most of the excess water by setting the Wash Timer Dial/Programme Selector to 'Spin'. After spinning remove from the drum, pull into shape and dry flat if possible. Avoid direct heat.

## **Blankets**

Blankets that are labelled 'Machine Washable' can be safely washed on the Wool Programme **7**. Most blanket manufacturers issue specific instructions for the treatment of their products.

Sometimes they will stipulate hand washing or dry cleaning. This particularly applies to wool cellular and honeycomb blankets which should not be machined washed.

## **Rinsing**

All wash cycles automatically include multiple rinses and the programmes for natural fibres go on to spin automatically. It is during the last of the rinses that fabric softener is taken into the machine.

The four programmes for synthetics and delicate fabrics (see page 12) have a 'pause' feature giving rinses and then retaining the last rinsing water. This useful feature prevents excess creasing. When you are ready to remove the clothes from the machine turn the Wash Timer Dial/Programme Selector to 'Spin' and the programme will be automatically completed.







## **Drip Dry Articles**

When you are ready to remove the clothes for drip drying, turn the Wash Timer Dial/Programme Selector to 'Spin' to drain the water and then turn further to the stop position.

After 1½ minutes delay, the door may be opened and the clothes removed.

Items that have been hand washed can be rinsed and spun in your Bendix using the rinse and spin sections of the wash cycles.

## Programme Guide

Programme	Fabric	Bio/ Pre-wash 40°C	Detergent Compartment		Main Wash	Number of rinses	Pause	Spin rpm	Full Load	Half Load	Notes
			Bio/ Pre-wash	Main Wash							
	Whites, cottons and linen	Select if required	A	B	95°C	4	No	1000	4.5 kg (10lb)	2.7 kg (6lb)	A very high temperature maximum wash action which allows oxygen bleaches to work to maximum effect. Keeps whites white.
Economy 60°C	White cottons and linen	No Bio/ Pre-wash	-	B	60°C	4	No	1000	4.5 kg (10 lb)	2.7 kg (6 lb)	Lightly soiled cottons, hot wash with maximum wash action.
	Colour fast cotton and linen	Select if required	A	B	60°C	3	No	1000	4.5 kg (10 lb)	2.7 kg (6 lb)	A hot wash with maximum wash action to keep colours bright and fresh looking.
	White nylon, Sturdy synthetics	Select if required	A	B	60°C	3	Yes	500	2 kg (4½ lb)	1.5kg (3¼ lb)	A hot wash with medium wash action for white nylon and white polyester cotton mixed. Always wash white nylon separately as it picks up dyes from coloured synthetics.
	Coloured nylon Polyester, cotton mixtures terylene drip dry	No Bio/ Pre-wash	-	A	50°C	3	Yes	500	2 kg (4½ lb)	1.5 kg (3¼ lb)	A warm wash with medium wash action to preserve the appearance of coloured synthetic fibre and cotton mixtures.
	Non-colour fast cotton and linen	No Bio/ Pre-wash	-	A	40°C	3	No	1000	4.5 kg (10 lb)	2.7 kg (6 lb)	A tepid wash with maximum wash action to prevent the transfer of colour from non fast coloured cottons and lines etc.
	Delicate fabrics	No Bio/ Pre-wash	-	A	*40°C	3	Yes	500	2 kg (4½ lb)	1.5 kg (3¼ lb)	A tepid wash with a minimum wash action to care for delicate fabrics.
	Machine washable woollens	No Bio/ Pre-wash	-	A	*40°C	3	Yes	500	1.5 kg (3¼ lb)	Always use Full Load	A tepid wash with special wash action to care for machine washable woollens.

## Stains

<b>Coffee, Tea, Fruit, Wine,</b>	These are usually removed in the wash. For old stains, soak in a biological wash product, then launder in the usual way.
<b>Grass, ink, Ballpoint</b>	Dab with methylated spirits over a soft cotton pad, then launder in the usual way. Do not use Methylated spirits on Tricel. Treat ink stains on Tricel with Glycerine.
<b>Tar</b>	Scrape off excess, dab with petrol, over a soft cotton pad. (Caution. Petrol is inflammable).
<b>Scorch</b>	Moisten light stains and soak in glycerine then wash. If stains remain, soak in one part hydrogen peroxide to nine parts water; wash through and rinse thoroughly.
<b>Iron Mould</b>	Soak light stains in lemon juice, press between damp cotton, repeat if necessary.
<b>Grease, Fat, Lipstick Blood, Egg, Milk Cream, Meat Juice</b>	Treat with a proprietary grease solvent. Soak in biological solution, then launder in the usual way.
<b>Mildew</b>	Treat with peroxide. Soak (using one part hydrogen peroxide to nine parts water), rinse well. Care must be taken with coloured fabrics.

Before washing your coloured garments - check that the colours are fast!!

Usually it is recommended that coloureds be washed separately from whites, but some fast dyed items i.e. sheets, towels can safely be washed together with your family household linen.

Non-fast coloured articles should be washed at the recommended temperature.

When using a stain remover, follow the maker's directions carefully. Never use full strength bleach on any fabrics.

Rinse thoroughly after any special treatment. Chemicals left in fabrics can weaken or destroy some fibres. Test delicate fabrics for possible damage to fibres before tackling the stained area.

## Guide to wash load weights

Regular Wash	Sheet ... Cotton	Double	2½lb.	1.1 kg
		Single	1½lb.	670g
	Other than cotton	Double	1½lb.	670g
		Single	1¼lb.	560g
	Cot Sheet		6oz.	170g
	Pillowslips Cotton		4oz.	113g
	Others		3oz.	85g
	Bath Towel		1½lb.	670g
	Hand Towel		9oz.	255g
	Tablecloth Small		8oz.	227g
	Large		1½lb	670g
	4 table napkins		6oz.	170g
Personal	Shirt ... Cotton		10oz.	283g
	Others		7oz.	198g
	Blouse ... Cotton		5oz.	142g
	Others		4oz.	113g
	Cotton Vest		4oz.	113g
	Underslip		4oz.	113g
	Panties		2oz.	56g
	Bras		1oz.	28g
	Pyjamas		12oz.	340g
	Nightdress		5oz.	142g
	Socks ... Long 2 pairs		6oz.	170g
	Short 2 pairs		3oz.	85g
	6 Hankies		3oz.	85g
1 doz. Nappies		2½lbs.	1.1kg	
Special Wash	Candlewick Bedspread			
	Double		7lbs	3.18kg
	Single		5lbs.	2.27kg
	Blanket ... Wool		4¼lb.	2kg
	Acrylic		3¼lb.	1.5kg
	Dress ... Cotton		12oz.	340g
	Others		12oz.	340g
	Sweater ... Wool		14oz.	400g
	Others ... Heavy		12oz.	340g
	Lightweight		6oz.	170g
	Crimplene Suit			
	Heavy Weight		3lb.	1.36kg
Lightweight		2lb.	910g	
Skirt		7oz.	198g	



## **BEFORE USING CHECK THAT .....**









1. The machine is plugged in and switched on.
2. Both HOT and COLD stopcocks are fully open (unless a cold water adaptor has been fitted. Bendix Part No. 25115).
3. The hoses are not kinked.
4. The laundry is loaded into the machine and the door is closed firmly.
5. The appropriate amount of detergent and fabric softener has been added to the detergent dispenser.
6. The **'half load'** button has been pressed where appropriate.
7. The Programme Selector knob has been turned to the appropriate programme (See wash chart on page 12).

## **AFTER USE**

1. Turn off the hot and cold stopcocks to the machine.
2. Make sure that the Programme Selector is at the 'O' position.
3. Switch off and disconnect from the power supply.
4. Leave the porthole door slightly ajar to help machine to dry out.

## Care Labelling

Nowadays many garments carry a label under the International Textile Care Labelling scheme indicating the correct type of wash treatment required. Sort your washing according to the Care Label present.

-  This process is used for white cotton and linen articles without special finishes and provides the most vigorous washing conditions. Wash temperature can be up to boiling (100°C) and agitation and spinning times are maximum. This ensures good whiteness and stain removal.
-  Process 2 is for cotton, linen or rayon articles without special finishes where colours are fast at 60°C. It provides vigorous wash conditions but at a temperature which maintains fast colours.
-  Used for white nylon or white polyester/cotton mixtures, this process is less vigorous than either 1 or 2. The wash temperature (60°C) is high enough to prolong whiteness, and cold rinsing followed by a short spinning minimises creases.
-  This process is for coloured nylon, polyester; cotton and rayon articles with special finishes; acrylic/cotton mixtures and coloured polyester/cotton mixtures. In all respects except for washing temperature it is the same as process 3. The lower temperature hand hot (50°C) safeguards the colour and finish.
-  Suitable for cotton, linen or rayon articles where colours are fast at 40°C, but not a 60°C, this process has warm wash (40°C), medium agitation, normal spinning or wringing. The low wash temperature is essential to safeguard colour fastness.
-  This is for those articles which require low temperature washing (40°C) minimum agitation, a cold rinse and a short spin e.g. acrylics; acetate and triacetate, including mixtures with wool; polyester/wool blends. These conditions preserve colour and shape and minimise creasing.
-  Similar to process 6, this process is for wool, including blankets, and wool mixtures with cotton or rayon; which needs low temperature washing (40°C) and minimum agitation but requires normal spinning. Washing in this way preserves colour, size and handle. These fabrics should not be subjected to hand wringing or rubbing.
-  Unlikely to appear on UK produced goods, this process is for silk and printed acetate fabrics, with colours which are not fast at 40°C, requiring to be washed at a very low temperature (30°C), with minimum agitation and spinning.
-  Again rarely to be found on UK produced goods, this process is for cotton articles with special finishes which benefit from a high temperature (95°C) wash but require drip drying.

 This symbol indicates those articles which must not be machine washed.

 Articles which must not be washed at all will bear this sign.

## Washing Temperatures

100°C	Boil	Self-explanatory
95°C	Very hot	Water heated to near boiling temperature.
60°C	Hot	Hotter than the hand can bear. The temperature of water coming from many domestic hot taps.
50°C	Hand-hot	As hot as the hands can bear.
40°C	Warm	Pleasantly warm to the hand
30°C	Cool	Feels cool to the touch



### BLEACHING



This symbol indicates that household (chlorine) bleach could be used. Care must be taken to follow the manufacturer's instructions.



When this symbol appears on a label household bleach must not be used.



### IRONING

The number of dots in the ironing symbol indicates the correct temperature setting - the fewer the dots the cooler the iron setting.



COOL



WARM



HOT



DO NOT IRON

## Fabric Softeners - e.g. Comfort

All fabrics particularly towels and nappies benefit from the use of fabric conditioners in the final rinse. Items of laundry feel softer, and easier to iron and the clinging effect of nylon is considerably reduced.

To use follow the manufacturer's instructions on the bottle.

## Tumble Drying

Articles marked with  symbol will benefit from tumble drying.

Articles market with  should not be tumbled dried.

## What's gone wrong?

If your machine won't work, check the following list and make sure that you haven't overlooked anything. It will certainly help you and us also.

1. Check that the machine is plugged in and switched on.
2. Check the fuse. You could try another appliance from the same outlet in case the main fuse has blown.
3. Be sure the hot and cold taps have been turned on fully.
4. Have you selected the Programme?
5. Look to see if the door is fully closed. The door safety switch prevents the machine from operating if the door is open.
6. Is your machine overloaded? If it is the motor protector switch will stop the machine. If overloading is the problem remove some of the clothes, taking care not to scald yourself in doing so.
7. Check that the drain and fill hoses are not kinked and have been fitted correctly (this is a very common cause particularly if the machine has been moved for any reason).
8. Does the drain screen need cleaning? (see page 7 but first drain of any water).
9. If the machine does not spin check for '**Pause**' condition - see Wash Guide.

If your machine still does not work after checking the list please contact your nearest TRICITY BENDIX Customer Service Centre (listed at back) or look under "Bendix" in the telephone book.

### **Note**

If on making a service call, our engineer discovers that the only attention required is to remedy one of the above conditions, a charge will have to be made whether or not the machine is in or out of the guarantee period or under Service Contract.

### **Moving House**

If you plan to move, contact your nearest TRICITY BENDIX Customer Service Centre to see what should be done before and during moving of your machine particularly in respect of refitting the transit straps.

## **CUSTOMER CARE**

### **TRICITY BENDIX Customer Information Centre**

**Your questions answered.** If you have any queries about your BENDIX Home Laundry Appliances, you are invited to contact our Customer Information Centre.

We have fully trained Home Economists and Technical Advisors, so whatever your query contact us by telephone or letter, using our free telephone and address service;

TRICITY BENDIX Customer Information Centre

Freepost

Portsmouth

PO3 5BR

Telephone 0800 525545

### **TRICITY BENDIX Customer Service Centres**

**Your Home Laundry repaired.** In the event of your Home Laundry Appliance requiring attention by one of our qualified Service Engineers we recommend you contact your local TRICITY BENDIX Customer Service Centre.

Before calling out an Engineer the 'Service Call Check' above should be carried out.

The telephone number of your local Customer Service Centre is detailed at back of the booklet.





## TRICITY BENDIX CUSTOMER SERVICE CENTRES

**ABERDEEN:** 0224 572586

**ALDERSHOT:** Gordon House, Gordon Road, Aldershot GU11 1LD.

Tel: 0252 29555. Telex: 858876

**BELFAST:** Prince Regent Road, Castlereagh, Belfast BT5 6QR.

Tel: 0232 793209. Telex: 74695

**BIRMINGHAM:** Unit 15, Charlton Drive, Corngreaves Trading Estate, Cradley Heath, Warley, West Midlands B64 7BJ. Tel: 0384 64971. Telex: 336617

**BRISTOL:** 5th Floor, Beacon Tower, Fishponds Road, Bristol BS16 3HQ.

Tel: 0272 651341. Telex: 449202

**CANVEY ISLAND:** 2-4 Sandhurst, Kings Road, Canvey Island, Essex SS8 0QY.

Tel: 0268 694144. Telex: 99416

**CARDIFF:** Guardian Industrial Estate, Clydesmuir Road, Tremorfa, Cardiff CF2 2QS.

Tel: 0222 460131. Telex: 498616

**EDMONTON:** Angel Road, Edmonton, London N18 3HL

Tel: 01 884 2284 Telex: 266193

**ELGIN:** Tel: 0343 45280

**GATESHEAD:** First Avenue, Team Valley Trading Estate, Low Fell,

Gateshead, Tyne & Wear NE11 OPW. Tel: 091 487 3321. Telex: 537314.

**GLASGOW:** 20 Cunningham Road, Clyde Estate, Rutherglen, Glasgow G73 1PP.

Tel: 041 647 4381. Telex: 779628

**GRIMSBY:** 0472 360689

**INVERNESS:** 0463 233018

**KENDAL:** 0539 31158

**MANCHESTER:** Ashton Street, Dukinfield, Cheshire SK16 4RN.

Tel: 061 330 5081. Telex: 666541

**NEWTON ABBOT:** 2nd Floor (Room 7), Bridge House, Courtenay Street, Newton Abbot,

Devon TQ12 2QS Tel: 0626 65909 Telex 42656

**NORTHAMPTON:** 0604 36669

**NORWICH:** 0603 617968

**NOTTINGHAM:** Acorn Park, Midway City Industrial Estate, Dunkirk, Nottingham NG7 2TN.

Tel: 0602 861131. Telex: 377251

**OXFORD:** Suite 3, Windrush Court, 56A High Street, Witney OX8 6BL.

Tel: 0993 4411. Telex: 83393

**PORTSMOUTH:** Customer Service Centre, Limberline Road, Hilsea, Portsmouth PO3 5JJ

Tel: 0705 667411. Telex: 86735

**SOUTHPORT:** Slaidburn Crescent, Fylde Road Industrial Estate, Southport PR9 9YF.

Tel: 0704 29221. Telex: 677201

**TAUNTON:** 0823 51137

**TELFORD:** Unit D2, Stafford Park 4, Telford, Salop TF3 3AS. Tel: 0952 618721. Telex: 35417

**TONBRIDGE:** 61-63 High Street, Tonbridge, Kent TN10 3RY. Tel: 0732 357722. Telex: 95269

**TRURO:** 0872 78702

**WAKEFIELD:** Monckton Farm Industrial Estate, Denby Dale Road, Wakefield WF2 7AU.

Tel: 0924 371851. Telex: 557744

**WREXHAM:** 0978 261847

**YORK:** 0904 641700

10.12.86

## Tricity Bendix Appliances Limited

Limberline Road, Hilsea, Portsmouth, Hants PO3 5JJ 0705 664466

82867/2