

**MK77M-V**

**Socket A**

**AMD Athlon XP / Duron Processor**

**Based DDR Main Board**

*User's Manual*

# WARNING

Thermal issue is highly essential for processors with a speed of 600MHz and above. Hence, we recommend you to use the CPU fan qualified by AMD or motherboard manufacturer. Meanwhile, please make sure CPU and fan are securely fastened well. Otherwise, improper fan installation not gets system unstable but also could damage both CPU and motherboard because insufficient thermal dissipation.

If you would like to know more about thermal topic please see **AMD website** for detailed thermal requirement through the address:

**<http://www.amd.com>**

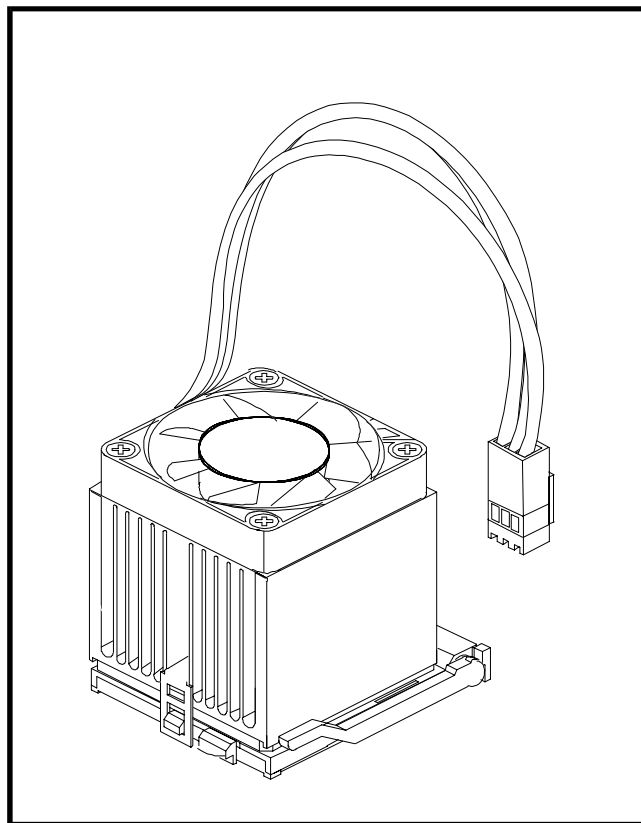

# MK77M-V

SocketA

AMD Athlon/ Duron Processor

based DDR Mainboard

Manual Version 1.0

## Disclaimer

This company shall not be liable for any incidental or consequential damages resulting from the performance or use of this product.

This company makes no representations or warranties regarding the contents of this manual. Information in this manual has been carefully checked for reliability; however, no guarantee is given as to the correctness of the contents. In the interest of continued product improvement, this company reserves the right to revise the manual or include changes in the specifications of the product described within it at any time without notice and without obligation to notify any person of such revision or changes. The information contained in this manual is provided for general use by the customers.

## Trademarks

VIA is a registered trademark of VIA Corporation.

AMD, Athlon, and Duron are registered trademarks of AMD Corporation.

PS2 is a registered trademark of IBM Corporation.

AWARD is a registered trademark of Award Software Inc.

Microsoft and Windows are registered trademarks of Microsoft Corporation.

**General Notice:** Other brand and product names used herein are for identification purposes and may be trademarks of their respective owners.

# TABLE OF CONTENTS

---

<b>WHAT'S IN THE MANUAL</b> .....	<b>5</b>
<b>Quick Reference</b> .....	<b>5</b>
<b>About This Manual</b> .....	<b>5</b>
<b>1 INTRODUCTION</b> .....	<b>6</b>
<b>1.1 TO DIFFERENT USERS</b> .....	<b>6</b>
First-Time DIY System Builder .....	6
Experienced DIY User .....	6
System Integrator .....	6
<b>1.2 ITEM CHECKLIST</b> .....	<b>7</b>
<b>2 FEATURES</b> .....	<b>8</b>
<b>2.1 SPECIFICATIONS</b> .....	<b>8</b>
<b>3 HARDWARE INSTALLATION</b> .....	<b>11</b>
<b>3.1 STEP-BY-STEP INSTALLATION</b> .....	<b>11</b>
STEP 1 Install the CPU .....	12
STEP 2 Set Jumpers .....	13
STEP 3 Install DDR SDRAM System Memory .....	13
STEP 4 Install Internal Peripherals in System Case .....	14
STEP 5 Mount the Mainboard on the Computer Chassis .....	15
STEP 6 Connect Front-panel Switches/LEDs/Speaker/USB .....	16
STEP 7 Connect IDE & Floppy Disk Drives .....	18
STEP 8 Connect Other Internal Peripherals .....	18
STEP 9 Connect Power Supply .....	19
STEP 10 Install Add-on Cards in Expansion Slots .....	20
STEP 11 Connect External Peripherals to Back-panel .....	20
STEP 12 Install Driver & Software Components .....	23

---

<b>3.2 JUMPER SETTINGS .....</b>	<b>24</b>
JUMPER & CONNECTOR GUIDE.....	25
<b><i>Jumpers</i></b>	
Clear CMOS (JP1) .....	28
BIOS Protection (JP2) .....	28
CPU Frequency (JP3).....	29
<b><i>Back-Panel Connectors</i></b>	
PS2 Keyboard & PS2 Mouse Connectors .....	30
COM Port Connector .....	30
VGA Connector .....	30
Parallel Port Connector .....	30
Line-Out .....	31
Line-In .....	31
Mic-In.....	31
MIDI/GAME Port .....	31
LAN Port Connector .....	31
USB Port Connector .....	32
<b><i>Front-Panel Connectors</i></b>	
HDD LED Connector (HDD LED) .....	33
Power LED Connector (Power LED) .....	33
Hardware Reset Connector (Reset Switch) .....	34
ATX Power On/Off Switch Connector (Power Switch) .....	34
Single color LED Header (SJ1) .....	35
Speaker Connector (SPEAKER1) .....	35
External SMI Header (J1) .....	35
Extended USB Header (USB2).....	36

---

<b><i>Internal Peripherals Connectors</i></b>	
Enhanced IDE Ports and Floppy Connectors .....	37
<b><i>Other Connectors</i></b>	
ATX Power Supply Connector (ATX1) .....	38
Cooling FAN Connectors for CPU FAN (CPUFAN1) and Case FAN (CASFAN1) .....	38
IR Header (SIR1) .....	39
Audio CD-IN Connector (CD1) .....	40
Audio Connector (CD2) .....	40
Front-Panel Microphone and Line-Out Header (AUDIO1) .....	40
SPDIF out Header (SPDIF1) .....	41
Wake-On-LAN Connector (WOL1) .....	41
Wake-On-Modem Connector (WOM1) .....	42
Serial2 Port Connector (COM2) .....	42
<b>3.3 SYSTEM MEMORY CONFIGURATION .....</b>	<b>43</b>
Install Memory .....	43
Upgrade Memory .....	43
<b>4 SOFTWARE UTILITY .....</b>	<b>44</b>
<b>4.1 Mainboard CD Overview .....</b>	<b>44</b>
<b>4.2 Install VIA Chipset Driver .....</b>	<b>45</b>
<b>4.3 Install VGA Driver .....</b>	<b>46</b>
<b>4.4 Install Audio Driver .....</b>	<b>47</b>
<b>4.5 Install LAN Driver .....</b>	<b>48</b>
Install WIN98 LAN driver .....	49
Install WINNT LAN driver .....	52
<b>4.6 View the User's Manual .....</b>	<b>54</b>

---

---

<b>5 BIOS SETUP .....</b>	<b>55</b>
<b>5.1 ENTER THE BIOS .....</b>	<b>55</b>
<b>5.2 THE MAIN MENU .....</b>	<b>56</b>
STANDARD CMOS FEATURES .....	58
ADVANCED BIOS FEATURES .....	62
ADVANCED CHIPSET FEATURES .....	66
INTEGRATED PERIPHERALS .....	71
POWER MANAGEMENT SETUP .....	75
PNP/ PCI CONFIGURATION .....	80
PC HEALTH STATUS .....	82
FREQUENCYVOLTAGE CONTROL .....	83
LOAD FAIL-SAFE DEFAULTS .....	84
LOAD OPTIMIZED DEFAULTS .....	84
SET SUPERVISOR PASSWORD .....	85
SET USER PASSWORD .....	85
SAVE & EXIT SETUP .....	86
EXIT WITHOUT SAVING .....	86

# WHAT'S IN THE MANUAL

---

## Quick Reference

Hardware Installation >> Step-by-Step .....	Page 11
Jumper Settings >> A Closer Look .....	Page 24
Software Utility >> How to Install .....	Page 44
BIOS Setup >> How to Configure .....	Page 55

## About This Manual

For First-Time DIY System Builder .....	Page 6
For Experienced DIY User .....	Page 6
For System Integrator .....	Page 6



# 1 INTRODUCTION

---

## 1.1 To Different Users

### First-Time DIY System Builder

Welcome to the DIY world! Building your own computer system is not as difficult as you may think. To make your first computer DIY experience successful, right from the start, we have designed the **Chapter 3 Hardware Installation** section in a step-by-step fashion for all the first-time DIY system builders. Prior to installation, we also suggest you to read the whole manual carefully to gain a complete understanding of your new MK77M-V mainboard.

### Experienced DIY User

Congratulate on your purchase of the MK77M-V mainboard. You will find that installing your new MK77M-V mainboard is just easy. Bundled with an array of onboard functions, the highly-integrated MK77M-V mainboard provides you with a total solution to build the most stable and reliable system. Refer to sections **3.2 Jumper Settings** and **Chapter 4 Software Utility** to find out how to get the best out of your new mainboard. **Chapter 5 BIOS Setup** also contains the relevant information on how to tune up your system to achieve higher performance.

### System Integrator

You have wisely chosen MK77M-V to construct your system. MK77M-V incorporates all the state-of-the-art technology of the KM266 chipset from VIA. It integrates the most advanced functions you can find to date in a compact Micro ATX mainboard.

---

## 1.2 Item Checklist

Check all items with you MK77M-V mainboard to make sure nothing is missing. The complete package should include:

- \* One piece of MK77M-V Mainboard

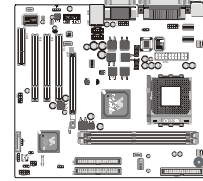

- \* One piece of ATA133/100/66 Ribbon Cable



- \* One piece of Floppy Ribbon Cable



- \* MK77M-V User's Manual



- \* I/O Shielding



- \* One piece of Bundled CD-ROM with containing:
  - MK77M-V user's manual on PDF format
  - VIA 4-IN-1 driver
  - VIA Audio driver
  - LAN driver
  - Award Flashing Utility



# 2 FEATURES

---

MK77M-V mainboard is carefully designed for the demanding PC user who wants high performance and maximum intelligent features in a compact package.

## 2.1 Specifications

### \* CPU Support

Support Socket462 package CPU with 200/266 MHz FSB.

### \* Chipset

Features VIA KM266, VT8735 N.B. and VT8233A S.B. Chipset.

### \* Jump CPU Configuration

Soft-configuration FSB (The FSB speed is software configurable to 100MHz and 133MHz).

### \* AC'97 Link for Audio and Telephony CODEC

AC'97 2.2 compliant.

Spread independent PCI functions for Audio and Modem.

### \* Versatile Memory Support

Two **184-pin DIMM** slots to support up to 2GB of PC1600 or PC2100 compliant **DDR SDRAM** module.

### \* PCI Expansion Slots

Provides three 32-bit PCI slots.

### \* AGP Expansion Slots

Provides one 32-bit AGP slot which supports up to 4X AGP devices.

### \* CNR Expansion Slots

Provides one CNR (Communication Network Riser) slot.

### \* 4 USB Supported Onboard

➤ 2\* USB connectors on back-panel and one set of dual USB ports headers on mid-board.

---

## \* IO Interface

Provides a variety of IO interfaces:

- 1\* Floppy interface for 3.5-inch FDD with 720KB, 1.44MB, or 2.88MB format or for 5.25-inch FDD with 360K or 1.2MB format.
- 1\* PS2 mouse connector.
- 1\* PS2 Keyboard connector.
- 1\* RJ45 LAN connector.
- 1\* DB9 Serial connectors 16550 UART compatible.
- 1\* Infrared communication port.  
(Serial port COM2 can also be redirected to an external IrDA Adapter for wireless connection.)
- 1\* DB25 Parallel port supporting Standard Parallel Port (SPP), Enhanced Parallel Port (EPP), and Extended Capabilities Port (ECP) data transmission schemes.
- 1\* Line-Out port.
- 1\* Line-In port.
- 1\* Mic-In port.
- 1\* MIDIGAME port.

## \* PCI Bus Master IDE Controller Onboard

Two UltraDMA **133/100/66** Bus Master Dual-channel IDE ports provide support to a maximum of four IDE devices (one Master and one Slave per channel). The IDE Bus implements the data transfer speed up to **133/100/66** MBsec and also supports Enhanced PIO Modes.

80-pin Cable Backward Compatible Legacy ATAPI Devices, ATAPI IDE CD-ROM, CD-R, CD-RW, and LS-120 Supports.

## \* ATX Power Supply Connector

ATX power supply unit can be connected to the onboard 20-pin ATX power connector, supporting Suspend and Soft-OnOff by dual-function power button.

## \* Advanced Configuration and Power Interface

Features four power saving modes: Snoop, Suspend to RAM, Suspend to Disk, and Soft-Off. ACPI provides more efficient Energy Savings Features controlled by your operating system that supports OS Direct Power Management (OSPM) functionality.

---

## \* **System BIOS**

Provides licensed Award BIOS V6.0 PG on 2Mb Flash EEPROM and supports Green PC, Desktop Management Interface (DMI).

## \* **Micro ATX Form Factor**

System board conforms to the Micor ATX specification.

Board dimension: 244mm\*220mm.

## \* **Advanced Features**

- **Dual Function Power Button** - The system can be in one of two states; one is Suspend mode and the other is Soft-Off mode. Pushing the power button for less than 4 seconds places the system into Suspend mode. When the power button is pressed for longer than 4 seconds, the system enters the Soft-Off mode.
- **Modem Ring Power-On** - The system can be powered on automatically by the activation of modem ring.
- **CPU Clock Setting** - This item allows users to adjust CPU Host Clock in BIOS.

## \* **Intelligent Features**

- **Voltage Monitoring** - Monitors various voltages of key elements, such as the CPU, and other critical system voltage levels to ensure stable current passing through mainboard components. System voltages include Vcore on CPU, +2.5V, +3.3V, +5V, +12V and Battery on system etc.
- **Fan Status Monitoring** - To prevent CPU from overheating, the CPU fan is monitored for RPM and failure. (CPU Cooling FAN with RPM sensor is required.)
- **Temperature Monitoring** - This item allows users to make sure whether the CPU or system runs in a suitable temperature.

# 3 HARDWARE INSTALLATION

**Before removing or installing any of these devices including CPU, DIMMs, Add-On Cards, Cables, please make sure to unplug the onboard power connector.**

This section outlines how to install and configure your MK77M-V mainboard. Refer to the following mainboard layout to help you identify various jumpers, connectors, slots, and ports. Then follow these steps to guide you through a quick and correct installation of your system.

## 3.1 Step-by-Step Installation

### Accessories Of MK77M-V

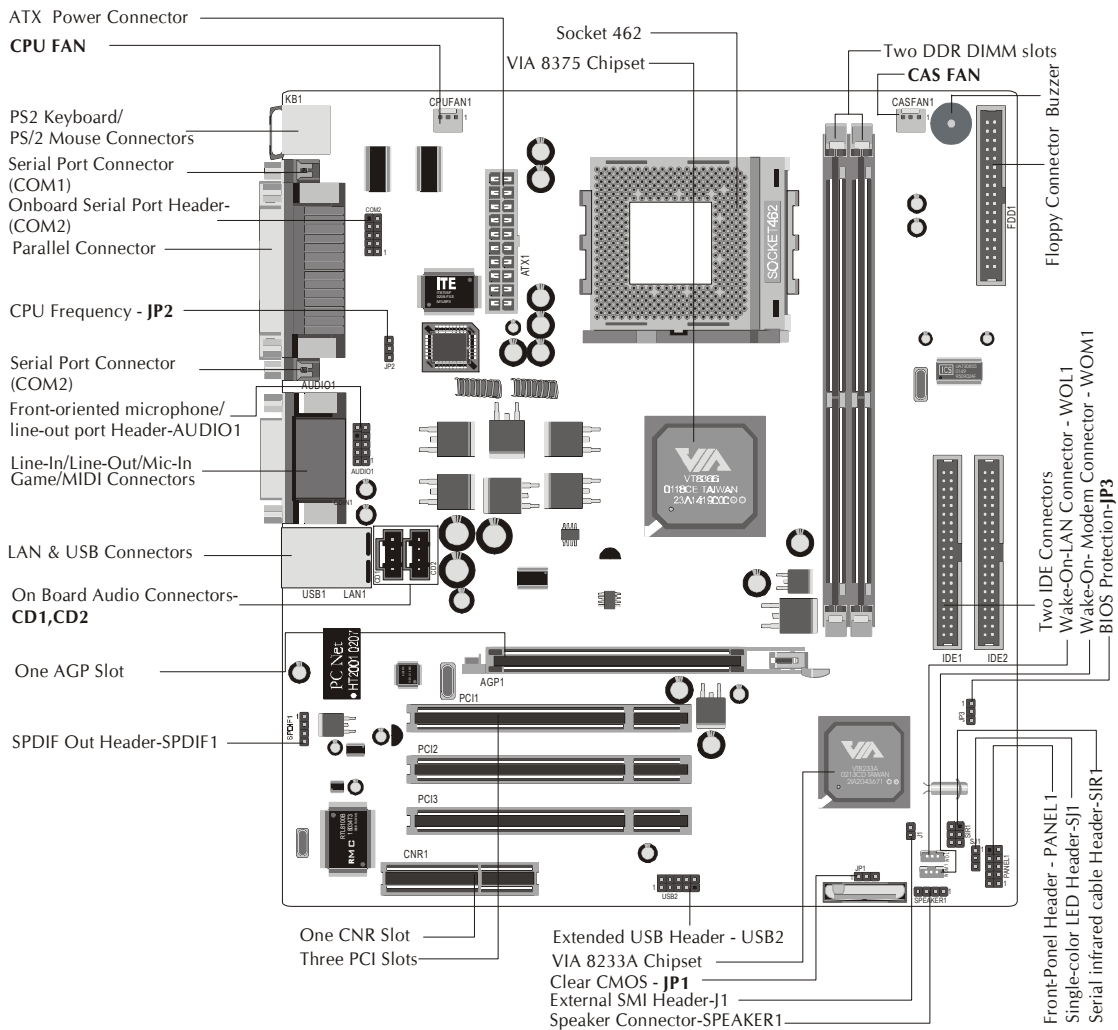

---

## Step 1

### Install the CPU:

1. Locate the CPU ZIF (Zero Insertion Force) socket on the upper-right sector of your mainboard (between the back-panel connectors and the DIMM memory slots).
2. Pull the CPU ZIF socket lever slightly sideways away from the socket to unlock the lever, and then bring it to an upwardly vertical position.
3. Place your AMD 462 Athlon/ Duron processor in the socket A. Note that the CPU edges have been purposely designed non-symmetrically to prevent from inserting the processor in the wrong direction. The following diagram demonstrates the correct placement of the CPU in the ZIF socket. You can see that the two blunt-edged corners should face towards the socket-lever.

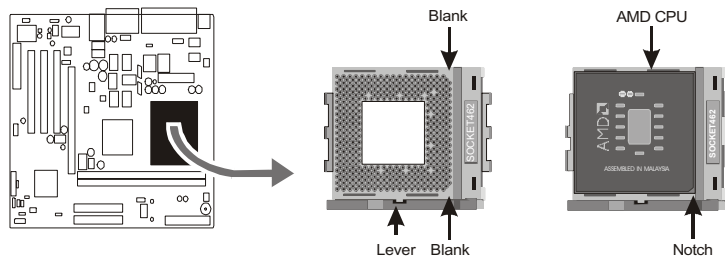

4. Slightly push the AMD 462 Athlon/ Duron processor into the socket without applying excessive force while making sure there is no gap between CPU and socket. Then lower the socket-lever all the way down to its horizontal position and lock it to secure the CPU in place.
5. The AMD 462 Athlon/ Duron processor requires a set of cooler to ensure proper cooling of the processor. If cooler have not been already mounted on your CPU, you must purchase a cooler separately and have it installed. Plug the cable through the cooler in the CPU fan power connector located nearby. Note that there are several types of CPU fan connectors. Normally, if your mainboard supports the hardware monitoring function, a 3-pin fan power connector should allow your system to detect the CPU fan's speed. The CPU fan can also run with a 2-pin fan power connector, however, detection of CPU fan's speed is not supported. Another type of CPU fan may feature a large 4-pin fan power connector, which does not support CPU fan's speed detection and must be directly connected to the system's power supply unit.

---

## Step 2.

### Set Jumpers

This mainboard is jumperless! The default jumper settings have been set for the common usage standard of this mainboard. Therefore, you do not need to reset the jumpers unless you require special adjustments as in any of the following cases:

1. Clear CMOS
2. BIOS Protection
3. CPU Frequency

For first-time DIY system builders, we recommend that you do not change the default jumper settings if you are not totally familiar with mainboard configuration procedures. The factory-set default settings are tuned for optimum system performance. For the advanced users who wish to customize their system, section **3.2 Jumper Settings** will provide detailed information on how to configure your mainboard manually.

## Step 3.

### Install DDR SDRAM System Memory

To install memory, insert SDRAM memory module(s) in any one or two or two DIMM banks. Note that SDRAM modules are directional and will not go in the DIMM banks if they are not properly oriented. After the module is fully inserted into the DIMM bank, lift the clips of both sides of the DIMM bank to lock the module in place.

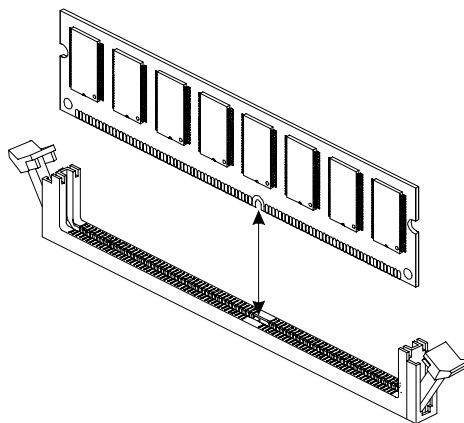



---

## **Step 4**

### **Install Internal Peripherals in System Case**

Before you install and connect the mainboard into your system case, we recommend that you first assemble all the internal peripheral devices into the computer housing, including but not limited to the hard disk drive (IDE HDD), floppy disk drive (FDD), CD-ROM drive, and ATX power supply unit. This will greatly facilitate in making the connections to the mainboard described below.

To install IDE & FDD drives, follow this procedure:

1. Set the required jumpers on board each device according to the instructions provided by the manufacturer. (IDE devices, HDD, and CD-ROM have to set jumpers on Master or Slave mode depending on your willing to install more than one device for each kind.)
2. Connect IDE cable and FDD cable on the back-panel of the internal peripheral devices to the corresponding headers on board. Note that the cable should be oriented with its colored stripe (usually in red or magenta) connected to pin#1 both on the mainboard IDE or FDD connector and on the device as well.
3. Connect an available power cable through your system power supply unit to the back-panel of each peripheral device. Note that the power cable is directional and cannot fit in if not properly positioned.

---

## Step 5

### Mount the Mainboard on the Computer Chassis

1. You may find that there are a lot of different mounting hole positions both on your computer chassis and on the mainboard. To choose a correct mounting hole, the key point is to keep the back-panel of the mainboard in a close fit with your system case, as shown below.

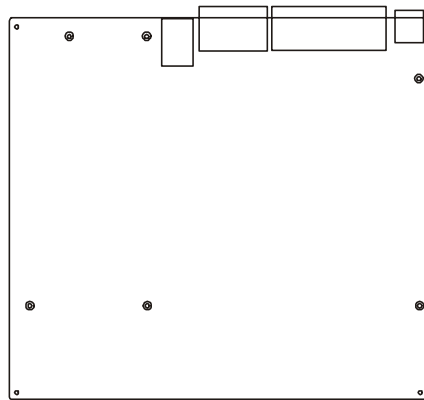

2. After deciding on the proper mounting holes, position the studs between the frame of chassis and the mainboard. The studs are used to fix the mainboard and to keep a certain distance between the system chassis and the mainboard, in order to avoid any electrical short between the board and the metal frame of chassis. (If your computer case is already equipped with mounting studs, you will need to tighten screws to attach the mainboard.)

**Note:** In most computer housings, you will be able to find 4 or more attachment points to install mounting studs and fix the mainboard. If there aren't enough matching holes, then make sure to install at least 4 mounting studs to ensure proper attachment of the mainboard.

## Step 6

### Connect Front-Panel Switches/LEDs/Speaker/USB connectors

You can find there are several different cables already existing in the system case and originating from the computer's front-panel devices (HDD LED, Power LED, Reset Switch, PC Speaker, or USB devices etc.) These cables serve to connect the front-panel switches, LEDs, and USB connectors to the mainboard's front-panel connectors group (PANEL1,SJ1,J1), as shown below.

#### 1.PANEL1

- (1). HDD\_LED (HDD LED)
- (2). Power\_LED (Power LED)
- (3). Hardware Reset Switch Button (Reset Switch)
- (4). ATX Soft Power On/Off (Power Switch)
- (5). Extended USB Header

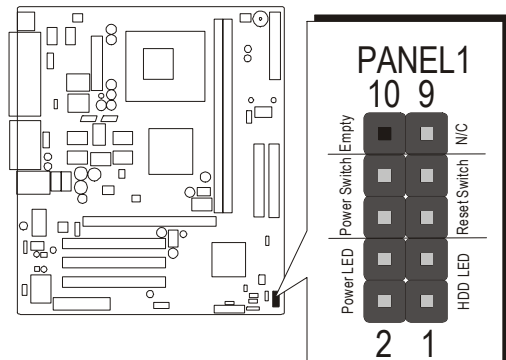
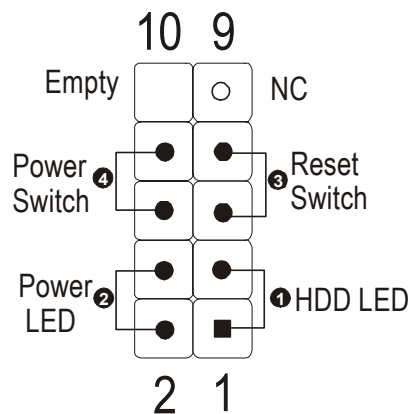

#### 2.USB 2

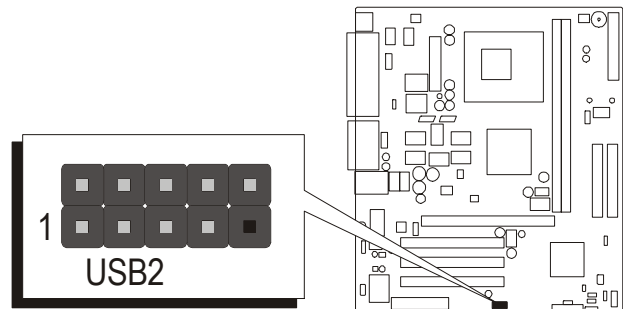
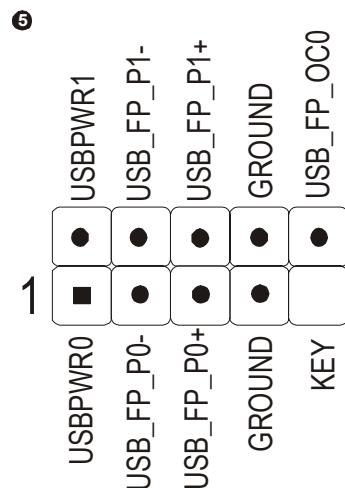

---

### 3. Single color LED header(SJ1)

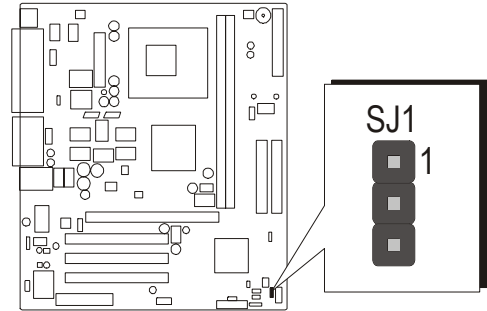

### 4.SPEAKER (SPEAKER 1)

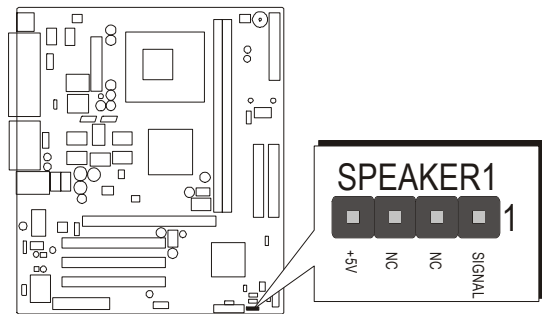

### 5. EPMI Header (J1)

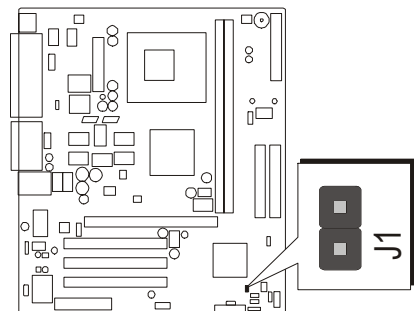

---

## Step 7

### Connect IDE & Floppy Disk Drives

1. IDE cable connector

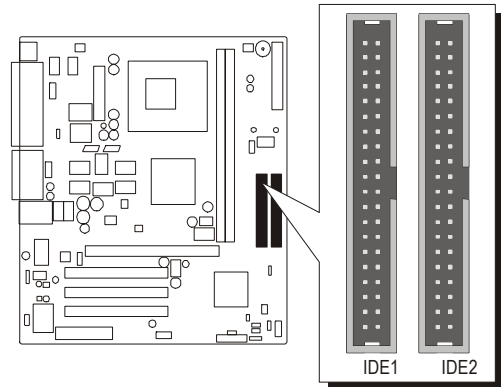

2. FDD cable connector

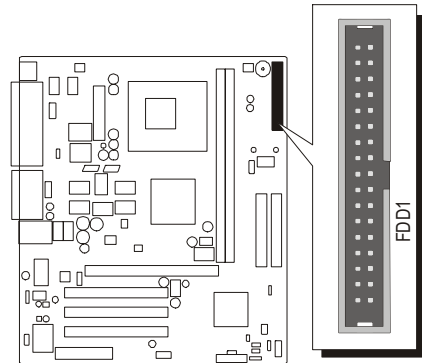

## Step 8

### Connect Other Internal Peripherals

1. CD1, CD2, and Front-Panel AUDIO1 connectors

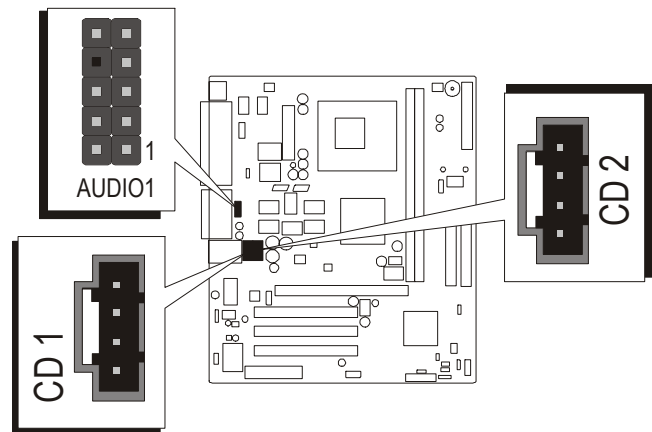

---

2. IR connector(SIR1)

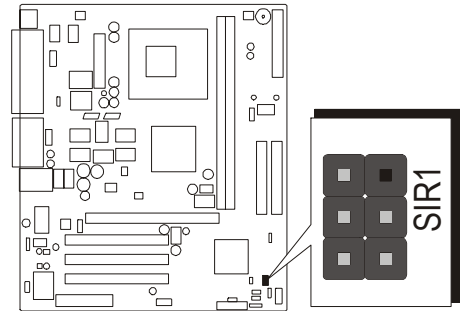

3. SPDIF connector(SPDIF1)

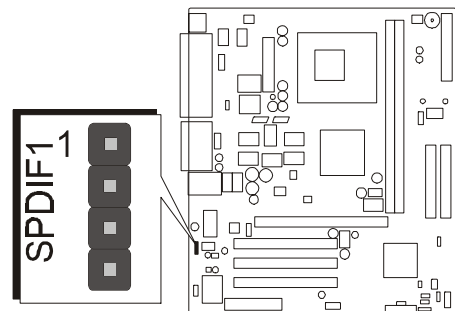

**Step 9**

**Connect Power Supply**

1. System power connector

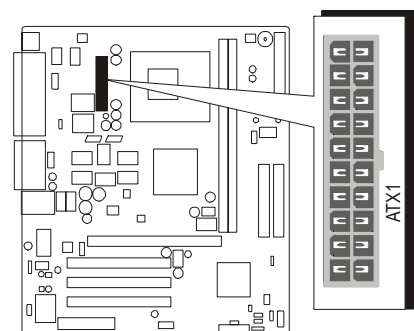

---

## Step 10

### Install Add-on Cards in Expansion Slots

1. PCI Card

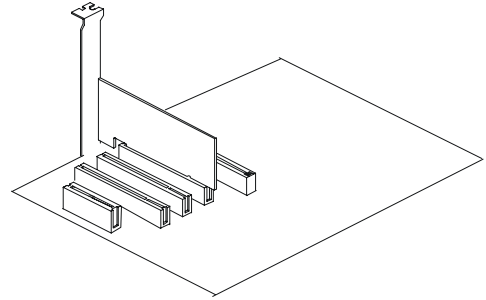

2. AGP Card

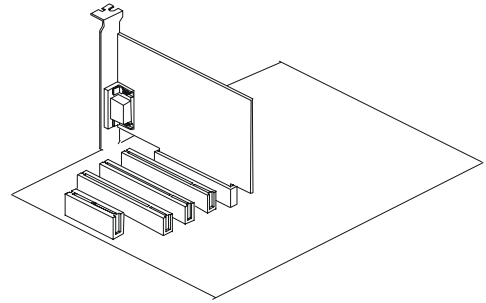

3. CNR Card

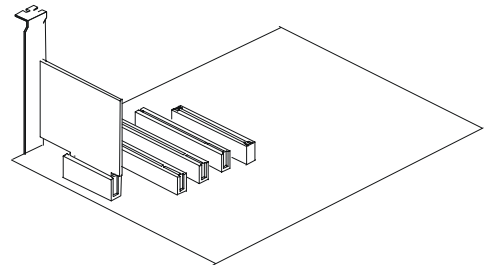

## Step 11

### Connect External Peripherals to Back-Panel

You are now ready to put the computer case back together and get on to the external peripherals connections to your system's back-panel.

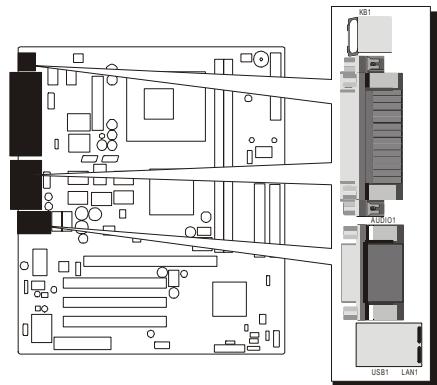

---

1. PS2 Mouse and Keyboard

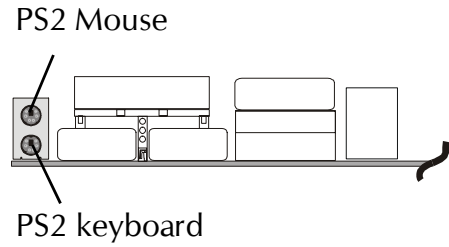

2. LAN Port

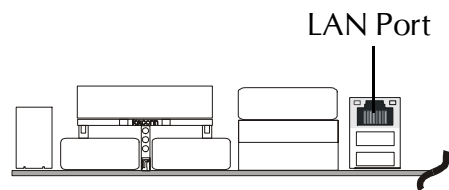

3. USB Ports

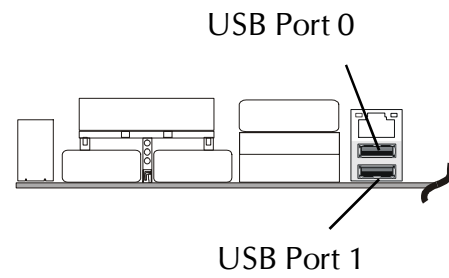

4. Parallel Port

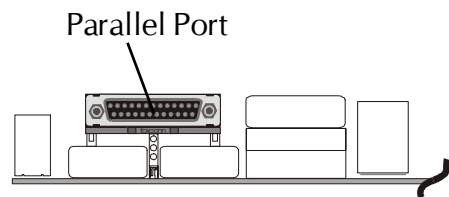

5. COM1 and VGA Ports

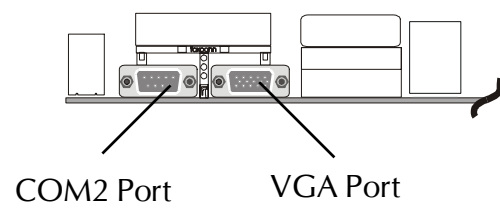



---

6. Audio Line\_out, Line\_in, Mic\_In

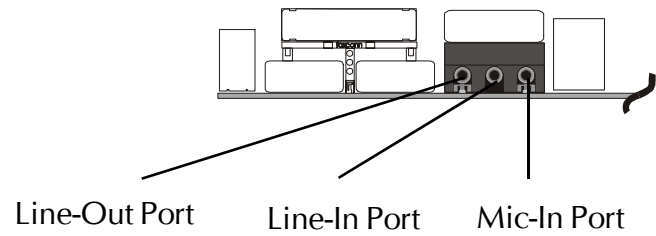

7. MIDI/ Game Port

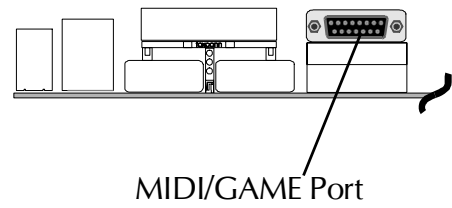

---

## **Step 12**

### **Install Driver & Software Components**

Please note that all the system utilities and drivers are designed for Win 9x / 2000/ME/NT operating systems . Make sure your operating system is already installed before running the drivers installation CD-ROM programs.

1. Insert the MK77M-V bundled CD-ROM into your CD-ROM drive.  
The auto-run program will display the drivers main installation window on screen.
2. Select the Mainboard related program.
3. Install VIA 4-in-1 and AC97 Sound drivers.
4. Install VIA onchip VGA drivers.
5. Install LAN driver.
6. Exit from the auto-run drivers installation program.

⚠ The LAN device driver can't be setup automatically, please refer to section **Chapter 4 Software Utility** to manual installation.

---

## 3.2 Jumper Settings

Several hardware settings are made through the use of jumper caps to connect jumper pins to the mainboard. Pin #1 could be located at any corner of each jumper; you just find a location marked with a white right angle, which stands for pin 1#. There are several types of pin 1# shown as below:

3-pin and multi-pin (> 3) jumpers show as follows:

Pin #1 to the left:



Pin #1 on the top:





Pin #1 to the right:



Pin #1 on the bottom:



Jumpers with two pins are shown as  for Close [On] or  for Open [Off]. To Short jumper pins, simply place a plastic jumper cap over the desired pair of pins.

### **Caution!**

1. Do not remove the mainboard from its antistatic protective packaging until you are ready to install it.
2. Carefully hold the mainboard by its edges and avoid touching its components. When putting the mainboard down, place it on the top of its original packaging film and on an even surface, and components side up.
3. Wear an antistatic wrist strap or take other suitable measures to prevent electrostatic discharge (ESD) whenever handling this equipment.

---

## Jumper & Connector Guide

Use the mainboard layout on page 11 to locate CPU socket, memory slots, expansion slots, jumpers and connectors on the mainboard during installation. The following list will help you identify jumpers, slots, and connectors along with their assigned functions:

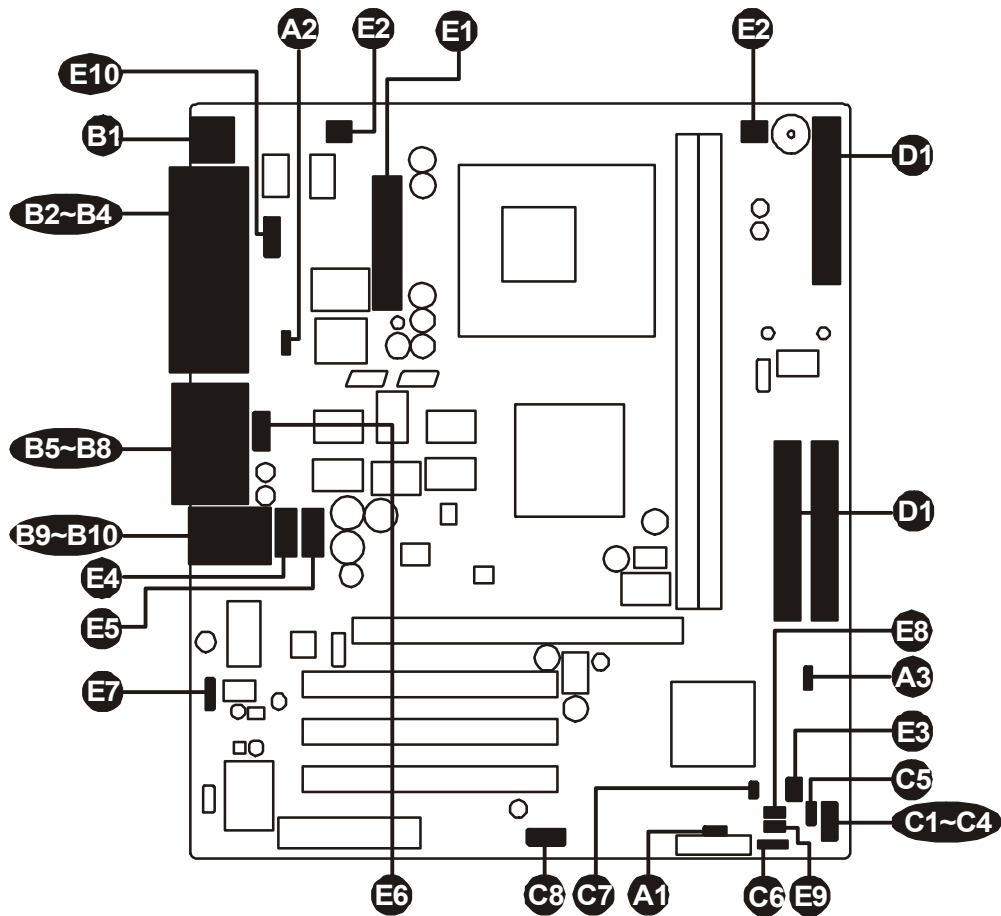

### ***CPU*MemoryExpansion Slots**

- Socket 462 : CPU Socket for AMD Athlon and Duron processors.
- DIMM1/ 2 : Two DIMM Slots for 64, 128, 256, 512 MB, and 1GB of 2.5V DDR SDRAM  
(The total installed memory does not exceed 2GB)
- AGP : One AGP (Accelerated Graphics Port) Slot
- PCI : Three 32-bit PCI Expansion Slots
- CNR : Communication Network Riser Card

---

### ***Jumpers***

- A1** JP1 : Clear CMOS
- A2** JP2 : BIOS protection
- A3** JP3 : CPU Frequency

### ***Back-Panel Connectors***

- B1** KB : PS2 Keyboard
- B1** MS : PS2 Mouse
- B2** COM1 : Serial Port 1 (DB9 male)
- B3** VGA : VGA Port (DB15 female)
- B4** PRINTER : Parallel Port (DB25 female)
- B5** LINE-OUT : Line-Out Port
- B6** LINE-IN : Line-In Port
- B7** MIC-IN : Mic-In Port
- B8** GAME/ MIDI : MIDI/ Game Port
- B9** LAN : RJ45 LAN Port
- B10** USB : 2 \* USB (Universal Serial Bus)

### ***Front-Panel Connectors (PANEL1,SPEAKER1)***

- C1** HDD LED : IDE driver active LED
- C2** Power LED : System power LED
- C3** RST : Hardware Reset Switch
- C4** Power Switch : ATX power on/off momentary type switch
- C5** SJ1 : Single color LED
- C6** SPEAKER 1 : Internal speaker in housing
- C7** J1 : System Management Interface
- C8** USB2 : Extended USB Header (USB Port 2/3)

### ***Internal Peripherals Connectors***

- D1** FDD : Floppy Disk Drive Interface
- D1** IDE1 : IDE Primary Interface (Dual-channel)
- D1** IDE2 : IDE Secondary Interface (Dual-channel)

---

**Other Connectors:**

<b>E1</b>	ATX1	: ATX Power (20-pin header)
<b>E2</b>	CAS FAN1	: Case Fan Power
<b>E2</b>	CPU FAN1	: CPU Fan Power
<b>E3</b>	SIR1	: IR Header
<b>E4</b>	CD1	: CD_IN connector
<b>E5</b>	CD2	: Audio connector
<b>E6</b>	Audio 1	: Front-oriented microphone/line-out port header
<b>E7</b>	SPDIF1	: SPDIF out header
<b>E8</b>	WOL1	: Wake-On-LAN connector
<b>E9</b>	WOM1	: Wake-On-Modem connector
<b>E10</b>	COM2	: Onboard Serial 2 port header.

---

👉 **Jumpers**

**A1 Clear CMOS (JP1)**

JP1 is used to clear CMOS data. Clearing CMOS will result in the permanent erasing of previous system configuration settings and the restoration of original (factory-default) system settings.



Pin 1-2 (Default)



Pin 2-3 (Clear CMOS)

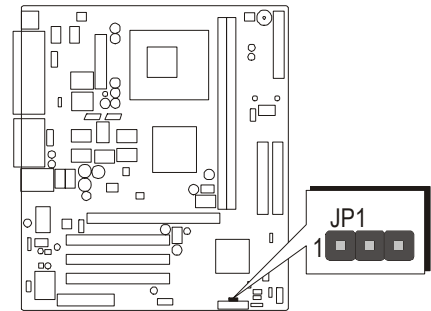

**A2 BIOS Write Protection (JP2)**

JP2 is used to protect BIOS from abnormal writing.

You may choose to place jumper cap on pins 1-2 for BIOS write protection; however, please place jumper cap on pins 2-3 if you need to reflash BIOS.



To enable reflashing  
the BIOS  
Pin 2-3 (Default)



BIOS write protection  
Pin 1-2

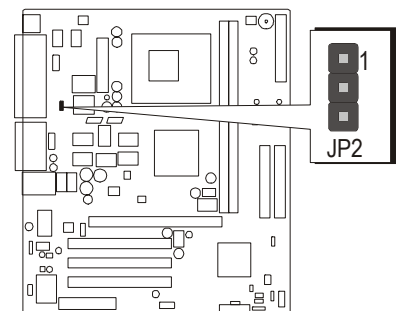

---

### **A3 CPU Frequency (JP3)**

JP3 is set the CPU frequency (100MHz or 133 MHz) according to the CPU. You may choose to place jumper cap on pins 1-2 for 100MHz; however, please place jumper cap on pins 2-3 if you need to run 133MHz.

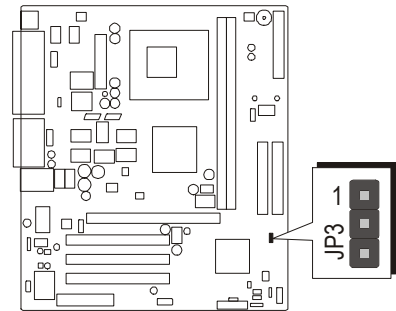
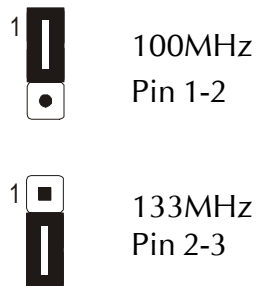



---

## ☞ **Back-Panel Connectors**

### **B1 PS/2 Keyboard & PS/2 Mouse Connectors**

Two 6-pin female PS/2 keyboard & Mouse connectors are located at the rear panel of the mainboard.

Depending on the computer housing you use (desktop or tower), the PS/2 Mouse connector is situated at the top of the PS/2 Keyboard connector when the mainboard is laid into a desktop, as opposed to a tower where the PS/2 Mouse connector is located at the right of the PS/2 Keyboard's. Plug the PS/2 keyboard and mouse jacks into their corresponding connectors.

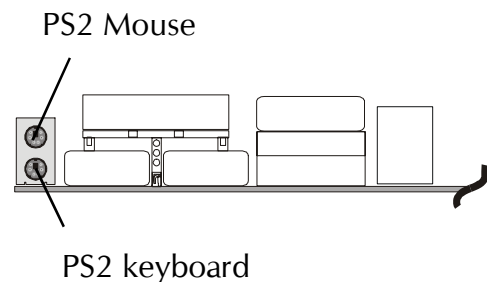

### **E2 COM Port Connector**

This mainboard can accommodate one serial device on COM Port.

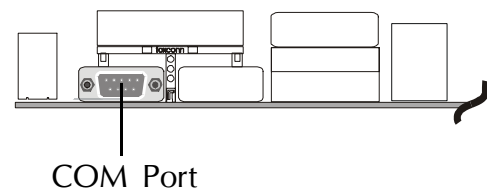

### **E3 VGA Connector**

One 15pin VGA connector is located at the rear panel of the mainboard.

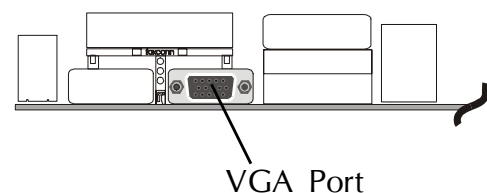

### **E4 Parallel Port Connector**

One DB25 female parallel connector is located at the rear panel of the mainboard. Plug the connection cable from your parallel device (printer, scanner, etc.) into this connector.

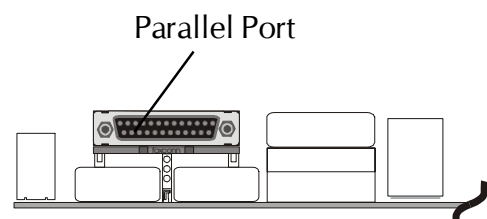

---

**B5 Line-Out Port**

Line-Out is a stereo output port through which the combined signal of all internal and external audio sources on the board is output. It can be connected to 1/8-inch TRS stereo headphones or to amplified speakers.

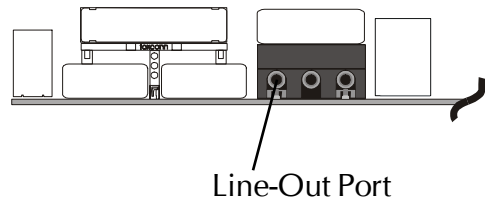

**B6 Line-In Port**

Line-In is a stereo line-level input port that accepts a 1/8-inch TRS stereo plug. It can be used as a source for digital sound recording, a source to be mixed with the output, or both.

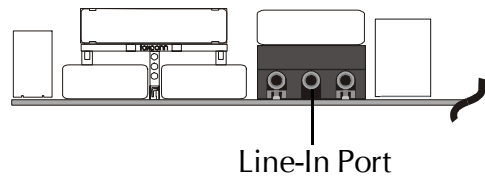

**B7 Mic-In Port**

MIC-IN is a 1/8-inch jack that provides a mono input. It can use a dynamic mono or stereo microphone with a resistance of not more than 600 Ohms.

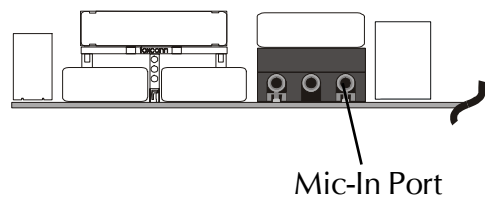

**B8 MIDI/GAME Port**

The MIDIGAME port is a 15-pin female connector. This port can be connected to any IBM PC compatible game with a 15-pin D-sub connector.

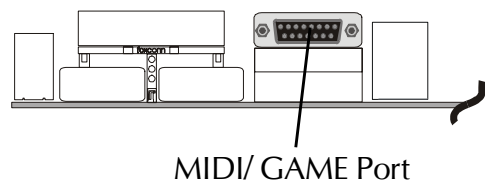

**MIDI Instrument Connection**

You will need a MIDI adapter to connect a MIDI compatible instrument to the sound card. The MIDI adapter can in turn be connected to the JoystickMIDE port. You will also need the MIDI sequencing software to run MIDI instruments with your computer.

**B9 LAN Port Connector**

This mainboard can accommodate one device on LAN.

Attach a 10/100 baseT cable to the RJ45 at the back-panel of your computer.

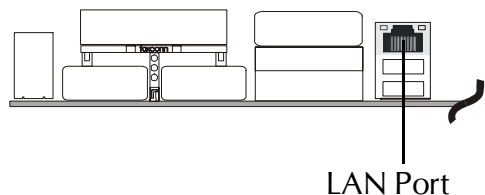

---

## **B10** USB Port Connectors

This mainboard offers 2 USB ports on front panel. Plug each USB device jack into an available USB1/USB2 connector.

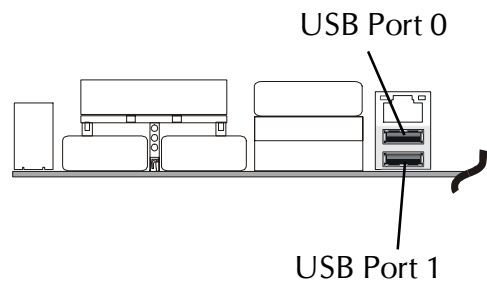

---

☞ **Front-Panel Connectors**

④ **HDD LED Connector (HDD LED)**

Attach the connector cable from the IDE device LED to the 2-pin HDD LED header. The HDD LED lights up whenever an IDE device is active.

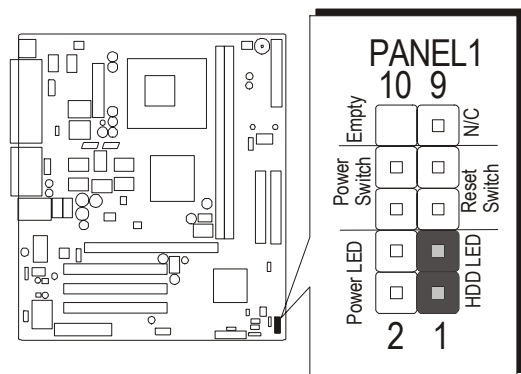

⑤ **Power LED Connector (Power LED)**

Attach the 2-pin Power-LED connector cable from the housing front-panel to the Power LED header on the mainboard. The Power LED stays light while the system is on.

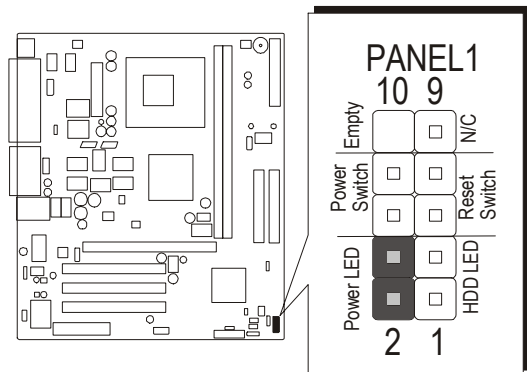

---

### ③ Hardware Reset Connector (Reset Switch)

Attach the 2-pin hardware reset switch cable to the Reset Switch header. Pressing the reset switch causes the system to restart.

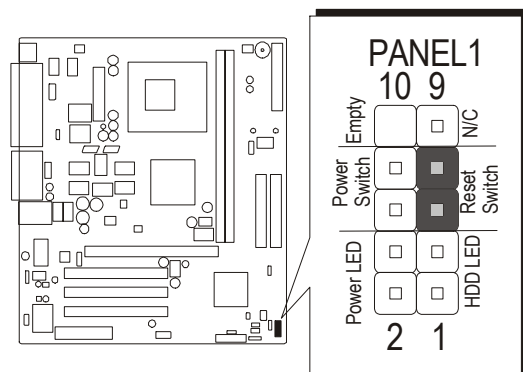

### ④ ATX Power On/Off Switch Connector (Power Switch)

The Power On/ Off Switch is a momentary-type switch used for turning on or off the system's ATX power supply. Attach the connector cable from the Power Switch to the 2-pin Power Switch header on the mainboard.

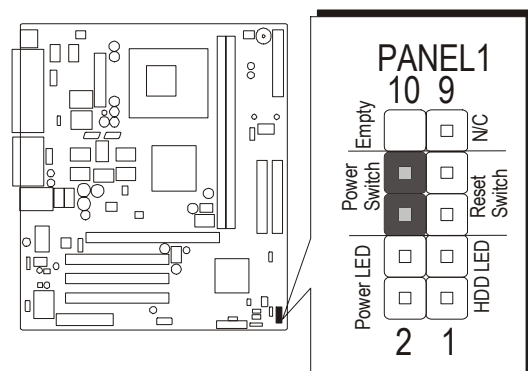

---

### C5 Single color LED Header (SJ1)

The headers is reserved for future use.

Pins Assignment:

1 = SUSLED-G

2 = SUSLED-G

3 = 5VSB

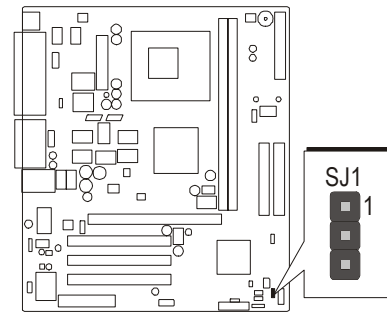
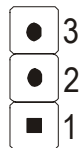

### C6 Speaker Connector (SPEAKER1)

Attach the PC speaker cable from the case to the 4-pin speaker connector (SPKR).

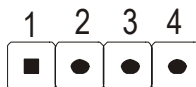

Pins Assignment:

1 = SIGNAL

2 = NC

3 = NC

4 = +5V

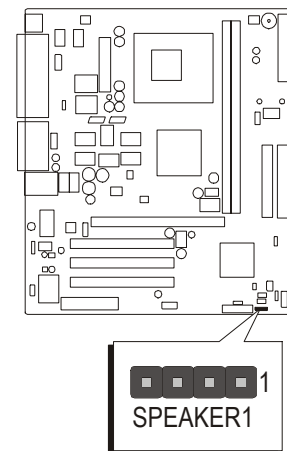

### C7 External SMI Header (J1)

Hardware System Management Interface (J1) header may attach to 2-pin momentary switch. Press the switch to force system into power saving mode; press it again to resume back the normal operation situation.

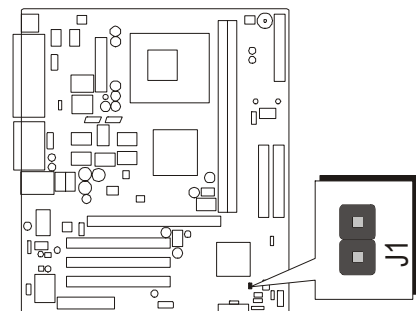

---

### ③ Extended USB Header (USB2)

The headers are used to connect the cable attached to USB connectors which are mounted on front-panel or back-panel. But the USB cable is optional at the time of purchase.

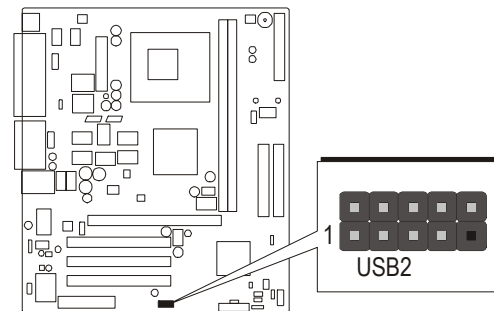
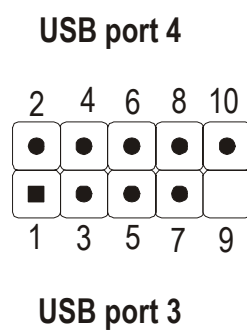

Pins Assignment:

- 1 = USBPWR0
- 3 = USB\_FP\_P0-
- 5 = USB\_FP\_P0+
- 7 = GROUND
- 9 = KEY
  
- 2 = USBPWR1
- 4 = USB\_FP\_P1-
- 6 = USB\_FP\_P1+
- 8 = GROUND
- 10 = USB\_FP\_OC0

---

## ☞ **Internal Peripherals Connectors**

### Ⓜ **Enhanced IDE Ports and Floppy Connector**

The MK77M-V mainboard features two 40-pin dual-channel IDE device connectors (IDE1/IDE2) providing support to up to four IDE devices, such as CD-ROM and Hard Disk Drives (H.D.D.). This mainboard also includes one 34-pin floppy disk controller (FDC) to accommodate the Floppy Disk Drive (F.D.D.). Moreover, this mainboard comes with one 80pin ATA133/100/66 ribbon cable to connect to IDE H.D.D. and one 34-pin ribbon cable for F.D.D. connection.

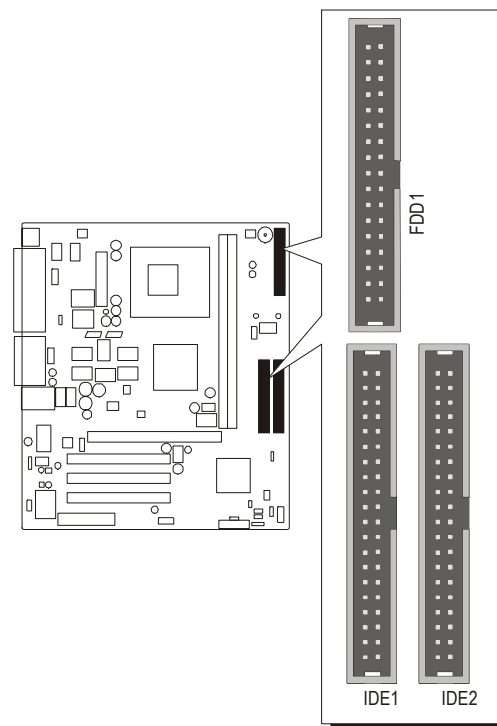

**Important:** Ribbon cables are directional, therefore, make sure to always connect with the red cable stripe on the same side as pin #1 of the IDE1/ IDE2 or FDD1 connector on the mainboard.



## Other Connectors

### ③ ATX Power Supply Connector (ATX1)

Locate the 20-pin male header ATX power connector (ATX1) on your mainboard. Plug the power cable from the ATX power supply unit directly into (PWR1) ATX power supply connector.

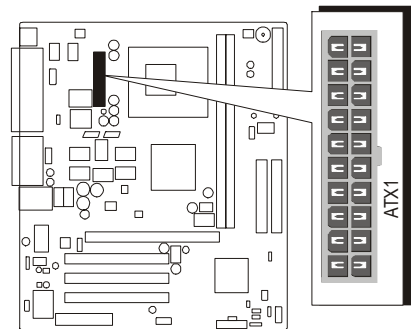
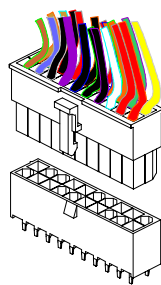

**Note 1:** The ATX power connector is directional and will not go in unless the guides match perfectly making sure that pin#1 is properly positioned.

**Note 2:** Make sure the latch of the ATX power connector clicks into place to ensure a solid attachment.

**Note 3:** Your ATX power supply must be supplied to ACPI +5V standby power and at least 720mA compatible.

**Note 4:** Make sure your power supply have enough power for higher speed processor installed.

### ④ Cooling Fan Connectors for CPU (CPUFAN1) and Case (CASFAN1) Fan

The mainboard provides three onboard 12V cooling fan power connectors to support CPU (CPUFAN1) and Case (CASFAN1) cooling fans.

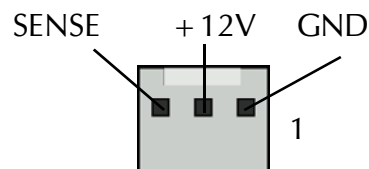

FAN1 with rotate sense.  
FAN2 without rotate sense.

**Note:** Both cable wiring and type of plug may vary depending on the fan maker. Keep in mind that the red wire should always be connected to the +12V header, and the black wire, to the ground (GND) header.

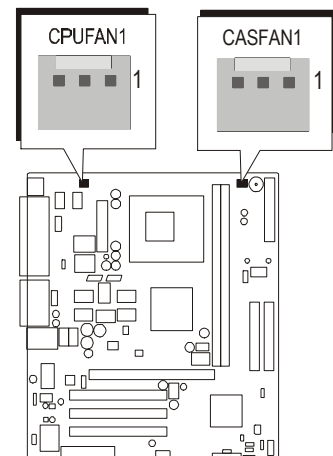

---

## ③ IR Header (SIR1)

If you have an Infrared device, this mainboard can implement SIR (Standard IR) transfer function. To enable the IR transfer function, follow these steps:

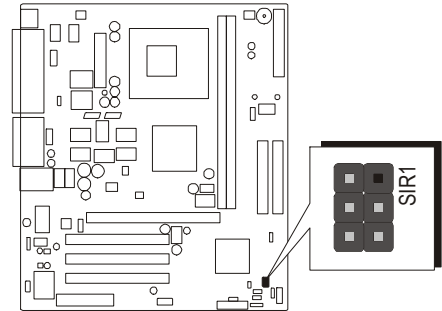
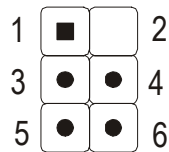

Pins Assignment:

1 = NC

2 = KEY

3 = + 5V

4 = GND

5 = IRTX

6 = IRRX

**Note:** Before connect your IR device, please be sure each IR on board pin allocation is matched with the pin of the IR device. Otherwise, incorrect IR connection may damage your IR device.

- Step 1.** Attach the 6-pin infrared device cable to SIR1 connector.  
(Refer to the above diagram for IR pin assignment.)
- Step 2.** Configure the Infrared transfer mode in field "UART Mode Select" of "Super IO Device" of "Integrated Peripheral" sub-menu in BIOS setup program. This mainboard supports Normal, IrDA or ASKIR transfer modes.

---

#### E4 Audio CD\_IN Connector (CD1)

Port CD1 is used to attach an audio connector cable from the CD-ROM drive.

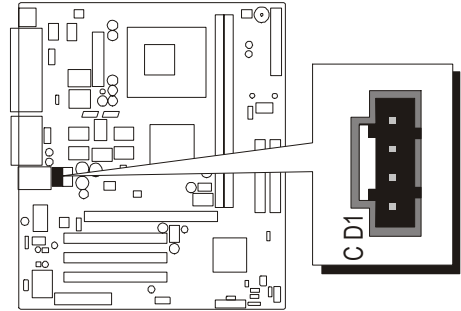
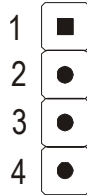

#### E5 Audio Connector (CD2)

Port CD2 can be used to connect a stereo audio input from CD-ROM, TV-tuner or MPEG card.

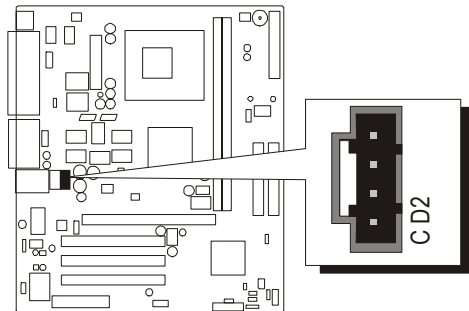
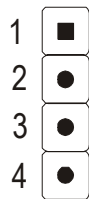

#### E6 Front panel Microphone and Line\_out Header (AUDIO1)

This header allows the user to install auxiliary front-panel microphone and line-out ports for easier access.

When frontpanel Microphone and line-out ports are not used, make sure replace two attached mini jumpers to the right position shown as below.

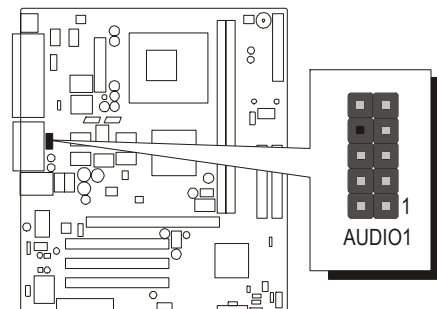
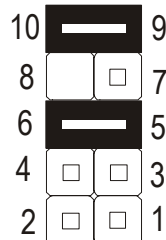

---

Pins Assignment:

- |              |                |
|--------------|----------------|
| 1 = AUD_MIC  | 2 = AUD_GND    |
| 3 = MIC_BIOS | 4 = AUD_VDD    |
| 5 = AUD_F_R  | 6 = AUD_RET_R  |
| 7 = RESERVED | 8 = KEY        |
| 9 = AUD_F_L  | 10 = AUD_RET_L |

### ⑦ SPDIF out header (SPDIF1)

You can purchase an optional 24-bit digital audio extension bracket from a third-party vendor. You can use the audio RCA jacks to connect to digital audio devices. If your CD-ROM/DVD drive has digital audio output, you can connect it to the input pins of the SPDIF connector.

Pins Assignment:

- |               |
|---------------|
| 1 = SPDIF Out |
| 2 = VCC       |
| 3 = KEY       |
| 4 = GND       |

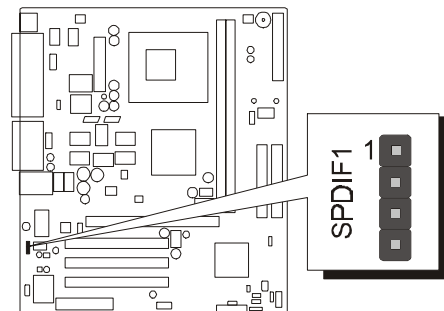
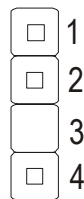

### ⑧ Wake-On-LAN Connector (WOL1)

Attach a 3-pin connector through the LAN card which supports the Wake-On-LAN (WOL1) function. This function lets users wake up the connected system through the LAN card.

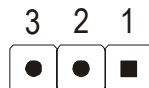

Pins Assignment:

- |           |            |
|-----------|------------|
| 1 = 5VSB  | 2 = Ground |
| 3 = SENSE |            |

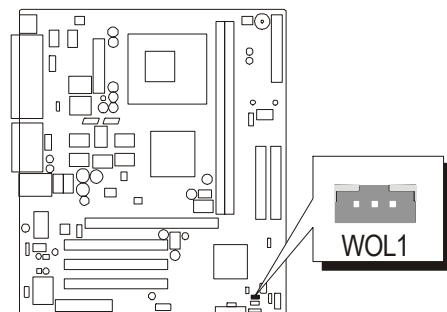

---

## Ⓔ Wake-On-Modem Connector (WOM1)

If you have installed a modem, use the cable provided with the modem to plug into the mainboard WOM1 connector. This enables the Wake On Modem(WOM1) feature. When your system is in a power-saving mode, any modem signal automatically resumes the system. You must enable this item using the Power Management page of the Setup Utility. See Chapter 3 for more information.

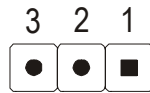

Pins Assignment:

1 = 5VSB      2 = Ground  
3 = SENSE

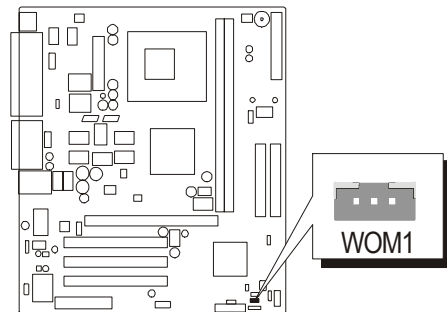

## Ⓕ COM2 Connector (COM2)

This mainboard built in with one 10-pin header for Serial 2 port (COM2).

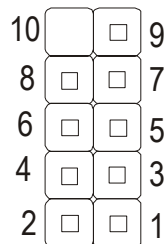

Pins Assignment:

1 = DCD      2 = RxD  
3 = TxD      4 = DTR  
5 = GROUND      6 = DSR  
7 = RTS      8 = CTS  
9 = RI      10 = KEY

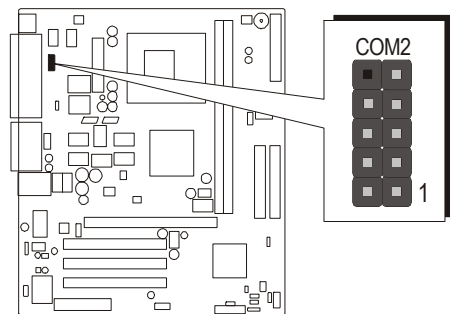

---

### 3.3 System Memory Configuration

The MK77M-V mainboard has two 184-pin DIMM banks that allow you to install from 128MB up to 2GB of system memory.

Each **184-pin** DIMM (Dual In-line Memory Module) bank can accommodate 128MB, 256MB, 512MB, and 1GB of PC1600/PC2100 compliant 2.5V single or double side 64-bit wide data path DDR SDRAM modules.

#### 1. Install Memory:

Install memory in any or all of the banks. The combination shown as follows.

DIMM Slot	Memory Modules	Module Quantity
DIMM 1	128MB, 256MB, 512M and 1GB, 184-pin 2.5V DDR SDRAM DIMM	x 1
DIMM 2	128MB, 256MB, 512M and 1GB, 184-pin 2.5V DDR SDRAM DIMM	x 1

**Maximum installed memory is 2GB.**

**Note:** You do not need to set any jumper to configure memory since the BIOS utility can detect the system memory automatically. You can check the total system memory value in the BIOS Standard CMOS Setup menu.

#### 2. Upgrade Memory:

You can easily upgrade the system memory by inserting additional SDRAM modules in available DIMM banks. The total system memory is calculated by simply adding up the memory in all DIMM banks. After upgrade, the new system memory value will automatically be computed and displayed in the field "Standard CMOS Setup" of BIOS setup program.

# 4 SOFTWARE UTILITY

---

## 4.1 Mainboard CD Overview

**Note:** The CD contents attached in the MK77M-V mainboard are subject to change without notice.

To start your mainboard CD disc, just insert it into your CD-ROM drive, and the CD AutoRun screen should appear. If the AutoRun screen does not appear, double click or run D:\Autorun.exe (assuming that your CD-ROM drive is drive D:)

### Navigation Bar Description:

- ☞ **Install VIA Chipset Driver** - Installing VIA Chipset driver.
- ☞ **Install VGA Device Driver** - Installing VIA VGA Device driver.
- ☞ **Install Audio Device Driver** - Installing Audio driver.
- ☞ **Install LAN Driver** - Installing LAN driver.
- ☞ **Manual** - MK77M-V Series mainboard user's manual in PDF format.
- F **Browse this CD** - Allows you to see the contents of this CD.
- ☞ **Quit** - Close this CD.

⚙ LAN Device Driver must be installed manually.

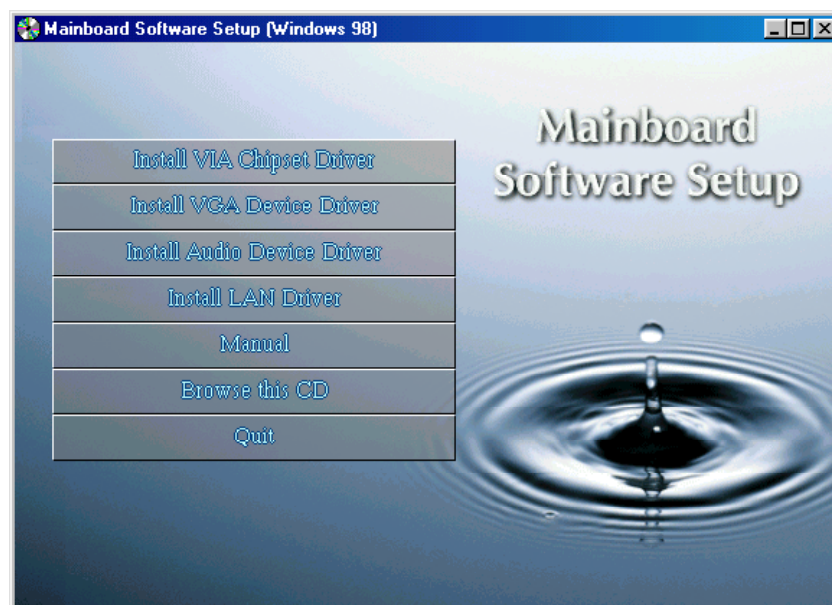

---

## 4.2 Install VIA Chipset Driver

Insert the attached CD into your CD-ROM drive, and the CD AutoRun screen should appear. If the AutoRun screen does not appear, double click on Autorun icon in **My Computer** to bring up **Mainboard Software Setup** screen.

Select using your pointing device (e.g. mouse) on the "**Install VIA Chipset Driver**" bar to install VIA Chipset Driver.



Once you made your selection, a Setup window run the installation automatically.

When the copying files is done, make sure you **reboot** the system to take the installation effect.



---

### 4.3 Install VGA Driver

Insert the attached CD into your CD-ROM drive, and the CD AutoRun screen should appear. If the AutoRun screen does not appear, double click on Autorun icon in **My Computer** to bring up **Mainboard Software Setup** screen.

Select using your pointing device (e.g. mouse) on the "**Install VGA Driver**" bar to install VIA VGA Driver.

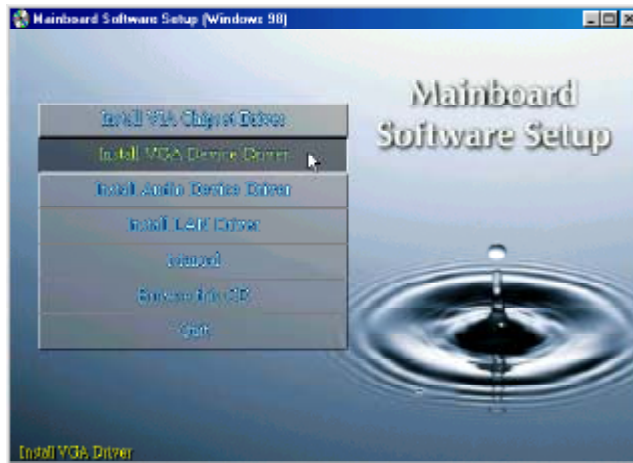

Once you made your selection, a Setup window run the installation automatically.

When the copying files is done, make sure you **reboot** the system to take the installation effect.

---

## 4.4 Install Audio Driver

Insert the attached CD into your CD-ROM drive, and the CD AutoRun screen should appear. If the AutoRun screen does not appear, double click on Autorun icon in **My Computer** to bring up **Mainboard Software Setup** screen.

Select using your pointing device (e.g. mouse) on the "**Install Audio Device Driver**" bar to install Hardware Audio Driver.



Once you made your selection, a Setup window run the installation automatically.

When the copying files is done, make sure you **reboot** the system to take the installation effect.

---

## 4.5 Install LAN Driver

Insert the attached CD into your CD-ROM drive, and the CD AutoRun screen should appear. If the AutoRun screen does not appear, double click on Autorun icon in **My Computer** to bring up **Mainboard Software Setup** screen.

Select using your pointing device (e.g. mouse) on the "**Install LAN Driver**" bar to install LAN Driver.



Once you made your selection, a Setup window run the installation automatically.

When the copying files is done, make sure you **reboot** the system to take the installation effect.

**Note:** When Install LAN driver, please confirm your OS and correctly install driver. If your OS is win 98/NT, please take the following next page for reference. The other OS such as win 2000/XP/ME can be automatical installed

---

## Install WIN98 LAN drivers

The LAN Device Driver can't be set up automatically, you need double click on **My Computer** -> **Control Panel** -> **System** icon to bring up **System Properties** screen.

Select tab "**Device Manager**".

You will find a yellow "?" mark at **PCI Ethernet Controller**, that means the driver is not recognize.

Double click on the **Ethernet Controller**.

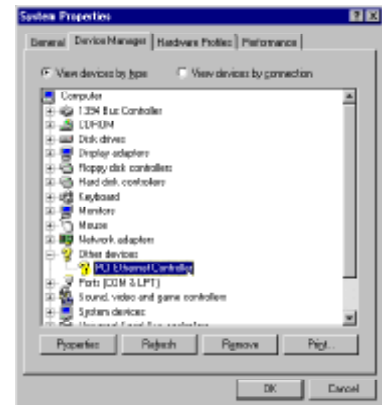

Then **PCI Ethernet Controller Properties** windows will appear on your screen.

Click on the "**Reinstall Driver**" bar to install driver.



The **Update Device Driver Wizard** windows will appear on your screen.

Click on "**Next**" bar to continue.



---

Please choose **"Display a list of the drivers in a specific location, so you can select the driver you want"** to the manual install driver, and click on **"Next"** bar to continue.



Select **"Network adapters"** bar for LAN device and click on **"Next"** bar to continue.

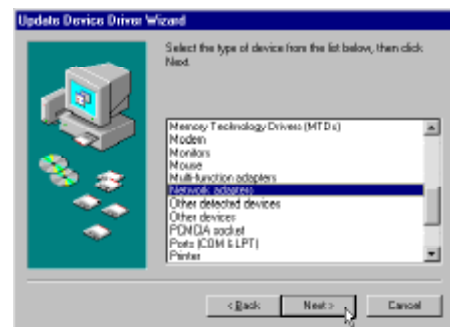

Insert the support CD by the mainboard manufacturer and choose **"Have Disk"** bar to continue next step.

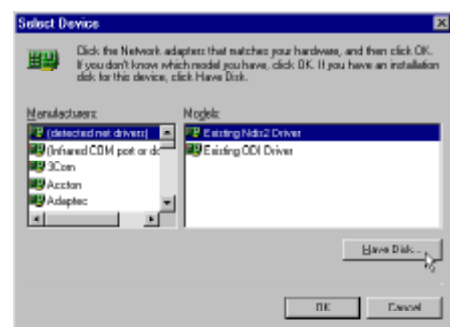

Indicate the driver's location as **"D:\lan\WIN98\NETRTS5.INF"** (In this location CD disk drive is supposed to be **"D"** letter.)



Select "**Realtek RTL8139 [A/B/C/8130] PCI Fast Ethernet NIC**" to install, and then click on "**OK**".



Make sure "**Realtek RTL8139 [A/B/C/8130] PCI Fast Ethernet NIC**" driver, and click on "**Next**".

Then the system will do the setup procedure automatically.



Completing the upgrade device driver, and click on "**Finish**" to restart the system to take all the changes effect.

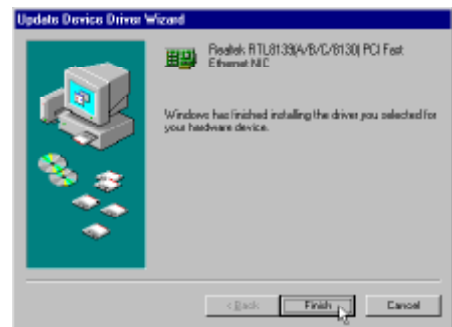

After restart, you may check Network adapters under the location mentioned at right figure.

The Network adapters shows correctly.

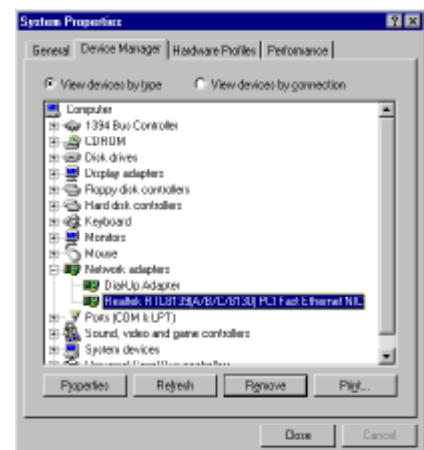

---

## Install WINNT LAN drivers

The LAN Device Driver can't be set up automatically, you need double click on Desktop **Network** icon to bring up **Network Setup Wizard** screen.

Select tab "**Adapters**" and "**Add**" bar to install driver.



Insert the support CD by the mainboard manufacturer and choose "**Have Disk**" bar to continue next step.

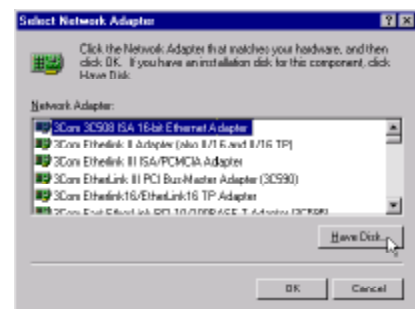

Key in the driver's location as "**D:\lan\WINNT4\**" (In this location CD disk drive is supposed to be "**D**" letter.) and click on "**OK**".



Select "**Realtek RTL8139 [A/B/C/8130] PCI Fast Ethernet Adapter**" to install then click on "**OK**".

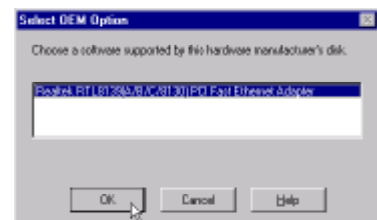

Chocse the proper Duplex Mode, and click on "**OK**".



Make sure "**Realtek RTL8139 [A/B/C/8130] PCI Fast Ethernet Adapter**" driver, and click on "**Close**".



Setting yourself network.  
Then the system will do the setup procedure automatically.



Completing the upgrade device driver, and click on "**Yes**" to restart the system to take all the changes effect.

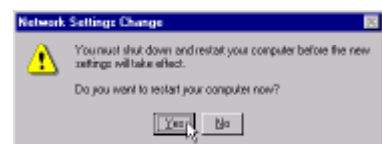

After restart, you may check Network adapters under the location mentioned at right figure. The Network adapters shows correctly.

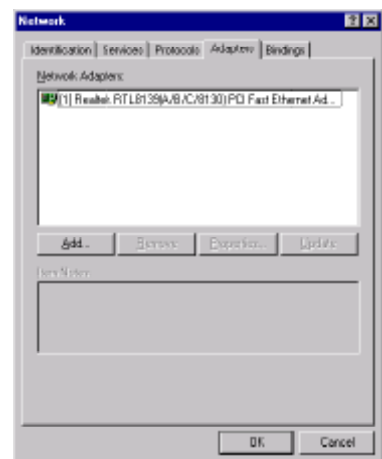



---

## 4.6 View the User's Manual

Insert the attached CD into your CD-ROM drive, and the CD AutoRun screen should appear. If the AutoRun screen does not appear, double click on Autorun icon in **My Computer** to bring up **Mainboard Software Setup** screen.

Select the item using your pointing device (e.g. mouse) on the "**Manual**" bar.



Then **Online Information** windows will appear on the screen. Click on the "**Install Acrobat Reader**" bar if you need to install acrobe reader.

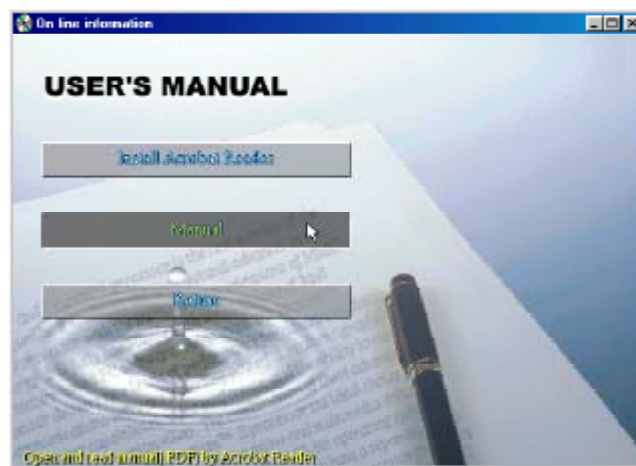

Then click on "**MK77M-V Manual**" bar to view MK77M-V user's manual.

# 5 BIOS SETUP

---

MK77M-V BIOS ROM has a built-in Setup program that allows users to modify the basic system configuration. This information is stored in battery-backed RAM so that it retains the Setup information even if the system power is turned off.

The system BIOS is managing and executing a variety of hardware related functions in the system, including:

System date and time

Hardware execution sequence

Power management functions

Allocation of system resources

## 5.1 Enter the BIOS

To enter the BIOS (Basic Input/ Output System) utility, follow these steps:

- Step 1.** Power on the computer, and the system will perform its POST (Power-On Self Test) routine checks.
- Step 2.** Press <Del> key immediately, or at the following message: "Press DEL to enter SETUP " or simultaneously press <Ctrl>, <Alt>, <Esc> keys

**Note 1.** If you miss trains of words mentioned in step2 (the message disappears before you can respond) and you still wish to enter BIOS Setup, restart the system and try again by turning the computer OFF and ON again or by pressing the <RESET> switch located at the computer's front-panel. You may also reboot by simultaneously pressing the <Ctrl>, <Alt>, <Del> keys.

**Note 2.** If you do not press the keys in time and system does not boot, the screen will prompt an error message, and you will be given the following options:

**"Press F1 to Continue, DEL to Enter Setup"**

- Step 3.** As you enter the BIOS program, the CMOS Setup Utility will prompt you the Main Menu, as shown in the next section.

---

## 5.2 The Main Menu

Once you enter the AwardBIOS(tm) CMOS Setup Utility, the Main Menu will appear on the screen. The Main Menu allows you to select from several setup functions and two exit choices. Use the arrow keys to select among the items and press <Enter> to accept and enter the sub-menu.

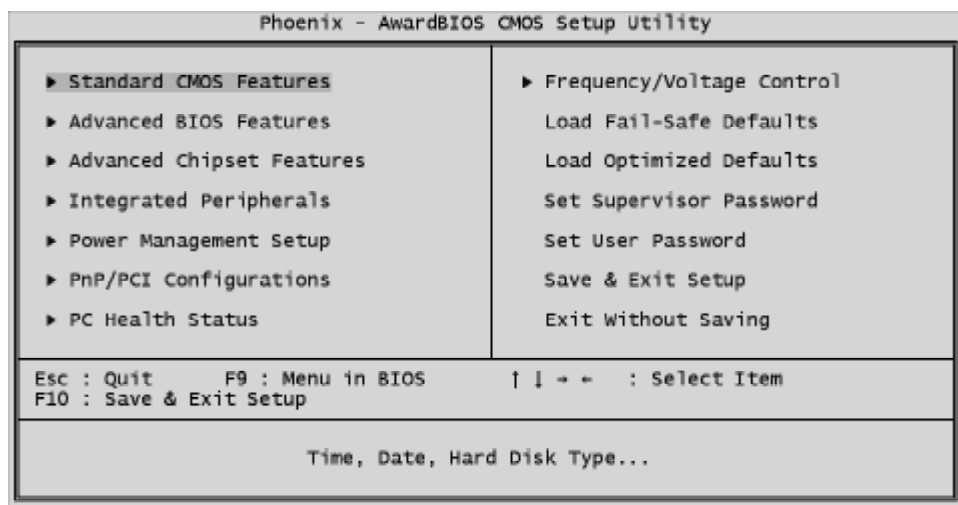

Note that a brief description of each highlighted selection appears at the bottom of the screen.

### **Setup Items**

The main menu includes the following main setup categories. Recall that some systems may not include all entries.

#### **Standard CMOS Features**

Use this menu for basic system configuration.

#### **Advanced BIOS Features**

Use this menu to set the Advanced Features available on your system.

#### **Advanced Chipset Features**

Use this menu to change the values in the chipset registers and optimize your system's performance.

---

### ***Integrated Peripherals***

Use this menu to specify your settings for integrated peripherals.

### ***Power Management Setup***

Use this menu to specify your settings for power management.

### ***PnP / PCI Configurations***

This entry appears if your system supports PnP/ PCI.

### ***PC Health Status***

This entry shows the current system temperature, Voltage, and FAN speed.

### ***Frequency/ Voltage Control***

Use this menu to specify your settings for frequency/ voltage control.

### ***Load Fail-Safe Defaults***

Use this menu to load the BIOS default values for the minimal stable performance of your system to operate.

### ***Load Optimized Defaults***

Use this menu to load the BIOS default values that are factory-set for optimal performance system operation. While Award has designed the custom BIOS to maximize performance, the factory has the right to change these defaults to meet users' needs.

### ***Set Supervisor / User Password***

Use this menu to change, set, or disable supervisor/ user password. It allows you to limit access to the system and BIOS Setup, program.

### ***Save & Exit Setup***

Save CMOS value changes in CMOS and exit from setup.

### ***Exit Without Saving***

Abandon all CMOS value changes and exit from setup.

---

☞ **Standard CMOS Features**

The items in Standard CMOS Setup Menu are divided into 10 categories. Each category includes no, one or more than one setup items. Use the arrow keys to highlight the item and then use the <PgUp> or <PgDn> keys to select the value you want in each item.

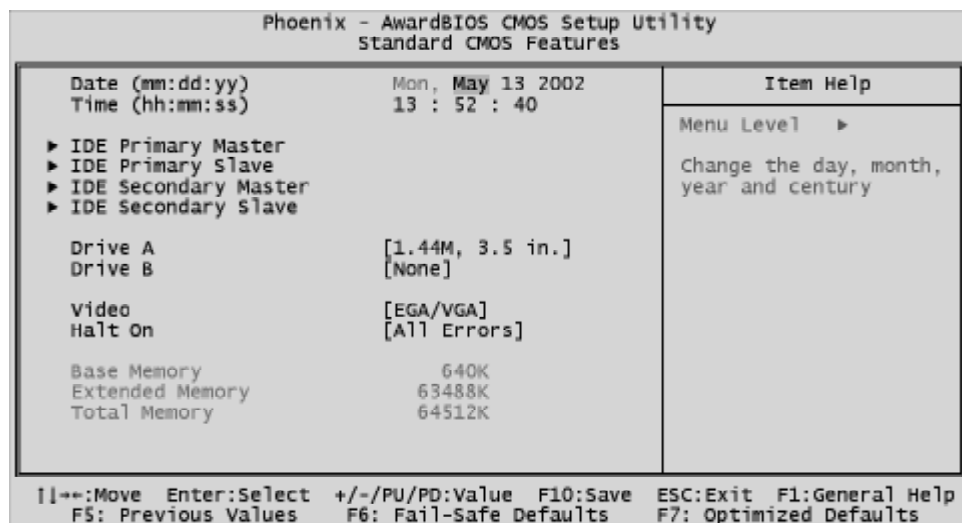

**Date**

<Month> <DD> <YYYY>

Set the system date. Note that the 'Day' automatically changes when you set the date.

**Time**

<HH : MM : SS>

The time is converted based on the 24-hour military-time clock. For example, 5 p.m. is 17:00:00.

**IDE Primary Master**

Options are in its sub-menu.

Press <Enter> to enter the sub-menu of detailed options.

**IDE Primary Slave**

Options are in its sub-menu.

Press <Enter> to enter the sub-menu of detailed options.

**IDE Secondary Master**

Options are in its sub-menu.

Press <Enter> to enter the sub-menu of detailed options.

---

### **IDE Secondary Slave**

Options are in its sub menu.

Press <Enter> to enter the sub-menu of detailed options.

### **Drive A Drive B**

Select the type of floppy disk drive installed in your system.

- The choice: None, 360K, 5.25 in, 1.2M, 5.25 in, 720K, 3.5 in, 1.44M, 3.5 in, or 2.88M, 3.5 in

### **Video**

This item defines the video mode of the system. This mainboard has a built-in VGA graphics system; you must leave this item at the default value.

- The choice: EGA VGA, CGA 40, CGA 80, or MONO

### **Halt On**

Select the situation in which you want the BIOS to stop the POST process and notify you.

- The choice: All Errors, No Errors, All, But Keyboard, All, But Diskette, or All, But DiskKey

### **Base Memory**

Displays the amount of conventional memory detected during boot up.

### **Extended Memory**

Displays the amount of extended memory detected during boot up.

### **Total Memory**

Displays the total memory available in the system.

---

\*\*\*\*\*

### **IDE Adapters**

The IDE adapters control the hard disk drive. Use a separate sub-menu to configure each hard disk drive.

#### **IDE HDD Auto-Detection**

Press <Enter> to auto-detect HDD on this channel. If detection is successful, it fills the remaining fields on this menu.

- Press Enter

#### **IDE Primary Master**

Selecting 'manual' lets you set the remaining fields on this screen and select the type of fixed disk. "User Type" will let you select the number of cylinders, heads, etc., Note: PRECOMP = 65535 means NONE!

- The choice: None, Auto, or Manual.

#### **Access Mode**

Choose the access mode for this hard disk.

- The choice: CHS, LBA, Large, or Auto.

#### **Capacity**

Disk drive capacity (Approximated). Note that this size is usually slightly greater than the size of a formatted disk given by a disk checking program.

- Auto-Display your disk drive size.

*The following options are selectable if the 'IDE Primary Master' item is set to 'Manual'*

#### **Cylinder**

Set the number of cylinders for this hard disk.

- Min = 0, Max = 65535

#### **Head**

Set the number of readwrite heads.

- Min = 0, Max = 255

---

**Precomp**

Warning: Setting a value of 65535 means no hard disk.

➤ Min = 0, Max = 65535

**Landing zone**

Set the Landing zone size.

➤ Min = 0, Max = 65535

**Sector**

Number of sector per track.

➤ Min = 0, Max = 255

\*\*\*\*\*



---

## Advanced BIOS Features

This section allows you to configure your system for basic operation. You have the opportunity to select the system's default speed, boot-up sequence, keyboard operation, shadowing, and security.

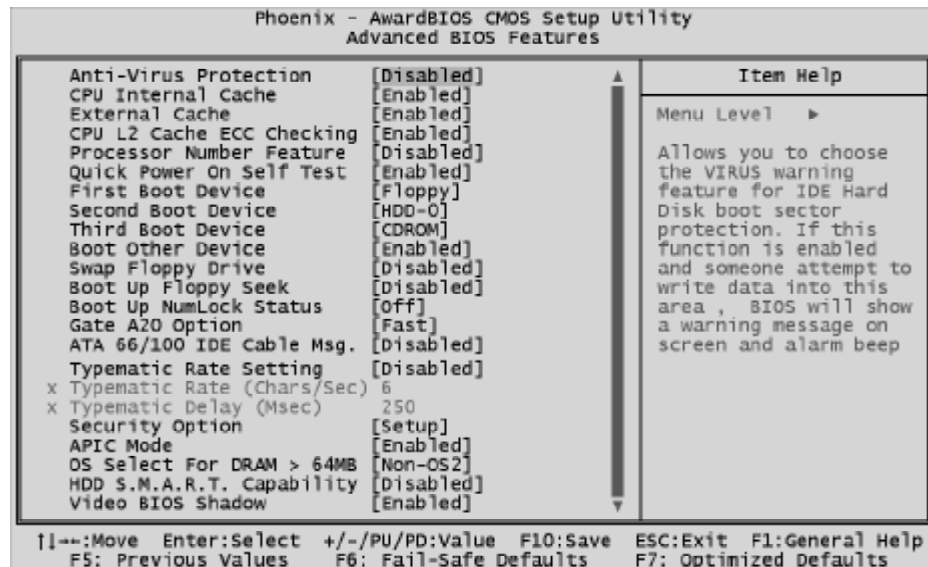

### Virus Warning

Allows you to choose the VIRUS Warning feature for IDE Hard Disk boot sector protection. If this function is enabled and someone attempts to write data into this area, BIOS will show a warning message on screen, and an alarm beep.

**Enabled** Activates automatically when the system boots up, causing a warning message to appear when anything attempts to access the boot sector or hard disk partition table.

**Disabled** No warning message will appear when anything attempts to access the boot sector or hard disk partition table.

➤ The choice: Enabled or Disabled.

### CPU Internal Cache

All processors that can be installed in this mainboard use internal level 1 (L1) cache memory to improve performance. Leave this item at the default value for better performance.

➤ The choice: Enabled or Disabled.

---

### **External Cache**

Most processors that can be installed in this system use external level 2 (L2) cache memory to improve performance. Leave this item at the default value for better performance.

- The choice: Enabled or Disabled.

### **CPU L2 Cache ECC Checking**

This item enables or disables ECC (Error Correction Code) error checking on the CPU cache memory. We recommend that you leave this item at the default value.

- The choice: Enabled or Disabled.

### **Processor Number Feature**

Allows you to make Pentium III Processor Serial Number enabled/disabled.

- The choice: Enabled, or Disabled.

### **Quick Power On Self Test**

This item speeds up Power-On Self Test (POST) after you power on the computer. If it is set to enabled, BIOS will shorten or skip some check items during POST.

- The choice: Enabled, or Disabled.

### **First/Second/Third Boot Device**

The BIOS attempts to load the operating system from the devices in the sequence selected in these items.

- The Choice: Floppy, LS120, HDD-0, SCSI, CDROM, HDD-1, HDD-2, HDD-3, ZIP100, LAN, or Disabled.

### **Boot Other Device**

Select Your Boot Device Priority.

- The choice: Enabled or Disabled.

### **Swap Floppy Drive**

If the system has two floppy drives, you can swap the logical drive name assignment.

- The choice: Enabled or Disabled.

### **Boot Up Floppy Seek**

Seeks disk drives during boot-up. Disabling speed boots up.

- The choice: Enabled or Disabled.

---

### **Boot Up NumLock Status**

This item defines if the keyboard Num Lock key is active when your system is started.

- The choice: Off or On.

### **Gate A20 Option**

This entry allows you to select how the gate A20 is handled. The gate A20 is a device used for above 1MByte of address memory. Initially, the gate A20 was handled via a pin on the keyboard. Today, while a keyboard still provides this support, it is more common and much faster in setting to Fast for the system chipset to provide support for gate A20.

- The choice: Normal, or Fast.

### **ATA 66/100 IDE Cable Msg**

Enable or disables the ATA 66/100 IDE Cable Msg. This message will appear during reboot when you use 40-pin cable on your 66/100 hard disks.

- The choice: Enabled or Disabled.

### **Typematic Rate Setting**

Keystrokes repeat at a rate determined by the keyboard controller. When this controller enabled, the typematic rate and typematic delay can be selected.

- The choice: Enabled or Disabled.

### **Typematic Rate (CharsSec)**

This item sets how many times the keystroke will be repeated in a second when you hold the key down.

- The choice: 6, 8, 10, 12, 15, 20, 24, or 30.

### **Typematic Delay (Msec)**

Sets the delay time after the key is held down before it begins to repeat the keystroke.

- The choice: 250, 500, 750, or 1000.

### **Security Option**

Select whether the password is required every time the system boots or when you enter setup.

---

**System** The system will not boot and access to Setup will be denied if the correct password is not entered promptly.

**Setup** The system will boot, but access to Setup will be denied if the correct password is not entered promptly.

➤ The choice: System or Setup.

Note: To disabled security, select PASSWORD SETTING at Main Menu, and then you will be asked to enter password. Do not type anything and just press <Enter > ; it will disable security. Once the security is disabled, the system will boot, and you can enter Setup freely.

#### **OS Select For DRAM > 64MB**

Selects the operating system that is running with greater than 64MB of RAM in the system.

➤ The choice: Non-OS2 or OS2.

#### **HDD S.M.A.R.T Capability**

This item enable/disable the HDD system management function.

➤ The choice: Enabled or Disabled.

#### **Video BIOS Shadow**

Determines whether video BIOS will be copied to RAM. However, it is optional depending on chipset design. Video Shadow will increase the video speed.

➤ The choice: Enabled or Disabled.

---

## ☞ **Advanced Chipset Features**

These items define critical timing parameters of the mainboard. You should leave the items on this page at their default values unless you are very familiar with the technical specifications of your system hardware. If you change the values incorrectly, you may introduce fatal errors or recurring instability into your system.

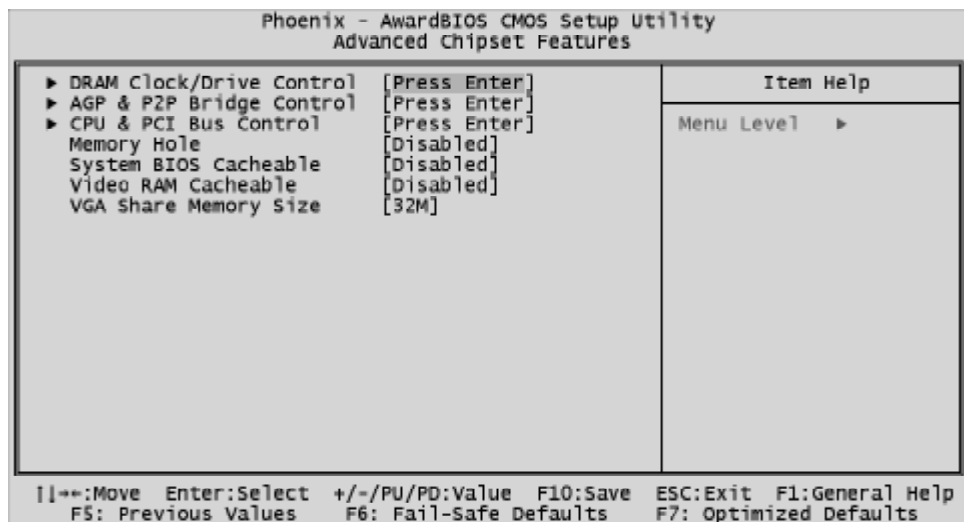

### **DRAM Clock/ Drive Control**

Options are in its sub-menu.

Press <Enter> to enter the sub-menu of detailed options.

### **Current FSB Frequency**

This item shows current CPU Front Side Bus speed.

### **Current DRAM Frequency**

This item shows current DRAM speed.

### **DRAM Clock**

This item allows you to control the DRAM speed.

- The Choice: Host CLK, 100MHz, 133MHz, or By SPD.  
When CPU speed set to 100MHz, DRAM speed can be set to 100MHz (by Host Clock), or 133MHz.  
When CPU speed set to 133MHz, DRAM speed set to 133MHz (by Host Clock).

---

### **DRAM Timing**

This item allows you to select the value in this field, depending on whether the board using which kind of DDR DRAM.

- The Choice: Manual or By SPD.

### **SDRAM CAS Latency**

This item enables you to select CAS latency time in HCLKs of 2/2 or 3/3. It's set at factory and depends on the DRAM installed. Don't change the value unless you change specifications of the CPU or DRAM installed.

- The Choice: 2.5.

### **Bank Interleave**

The interleave number of internal banks, can be set to 2 way, 4 way interleave or disabled. For VCM and 16Mb type dram chips, the bank interleave is fixed at 2 way interleave.

When the dram timing is selected by SPD, it will be set by the value on SPD of the RAM module(SDR).

- The Choice: Disabled, 2 Bank, or 4 Bank.

### **Precharge to Active(Trp)**

This item allows you to Precharge Command to Active Command Period.

- The Choice: 3T.

### **Active to Precharge(Tras)**

This item allows you to Active Command to Precharge Command Period.

- The Choice: 6T.

### **Active to CMD(Trcd)**

This item allows you to Active to CMD.

- The Choice: 3T .

### **DRAM Command Rate**

This item allows you to select the DRAM executed rate.

- The Choice: 2T Command or 1T Command .

---

### **APG & P2P Bridge Control**

Options are in its sub-menu.

Press <Enter> to enter the sub-menu of detailed options.

#### **AGP Aperture Size (MB)**

Select the size of Accelerated Graphics Port (AGP) aperture. The aperture is a portion of the PCI memory address range dedicated to graphics memory address space. Host cycles that hit the aperture range are forwarded to the AGP without any translation.

➤ The Choice: 4M, 8M, 16M, 32M, 64M, 128M, or 256M.

#### **AGP Driving Control**

This item enables the system to automatically select its output buffer drive strength or make it manually selectable by an end user.

➤ The Choice: Auto or Manual.

#### **AGP Driving Value**

This item enables an end user to manually select the AGP output buffer drive strength.

➤ Key in a HEX number: Min = 0000, Max = 00FF.

#### **AGP Fast Write**

This item enables an end user to manually select the AGP output buffer drive strength.

➤ The Choice: Enabled or Disabled.

#### **AGP Master 1 WS Write**

When this item enabled, writing to the AGP(Accelerated Graphics Port) is executed with one wait state.

➤ The Choice: Enabled or Disabled.

#### **AGP Master 1 WS Read**

When this item enabled, reading from the AGP (Accelerated Graphics Port) is executed with one wait state.

➤ The Choice: Enabled or Disabled.

### **CPU & PCI Bus Control**

Options are in its sub-menu.

Press <Enter> to enter the sub-menu of detailed options.

---

### **PCI1Master 0 WS Write**

When this item enabled, writing to the PCI bus is executed with zero wait state.

- The Choice: Enabled or Disabled.

### **PCI2 Master 0 WS Write**

When this item enabled, writing to the AGP bus is executed with zero wait state.

- The Choice: Enabled or Disabled.

### **PCI1 Post Write**

This Item enable/disable AGP post write function, which means when cpu accessing the AGP data, the chipset can queue the instruction when the AGP bus is busy, then write the data when AGP bus is available .

- The Choice: Enabled or Disabled.

### **PCI2 Post Write**

This Item enable/disable PCI post write function, which means when cpu accessing the PCI data, the chipset can queue the instruction when the PCI bus is busy, then write the data when AGP bus is available.

- The Choice: Enabled or Disabled.

### **PCI Delay Transaction**

The chipset has an embedded 32-bit posted write buffer to support delay transactions cycles. Select Enabled to support compliance with PCI specification version 2.1.

- The Choice: Enabled or Disabled.

### **Memory Hole**

In order to improve performance, some space in memory can be reserved for ISA cards.

- The Choice: Disabled or 15M-16M.

### **System BIOS Cacheable**

Selecting Enabled allows caching of the system BIOS ROM at F0000h-FFFFFh, resulting in better system performance. However, if any program is written to this memory area, a system error may result.

- The choice: Enabled or Disabled.



---

### **Video RAM Cacheable**

Selecting Enabled allows caching of the video RAM , resulting in better system performance. However, if any program is written to this memory area, a system error may result.

- The Choice: Enabled or Disabled.

### **VGA Share Memory Size**

These items allows you to select the shared memory size for VGA usage.

- The Choice: 8M, 16M or 32M.

---

☞ **Integrated Peripherals**

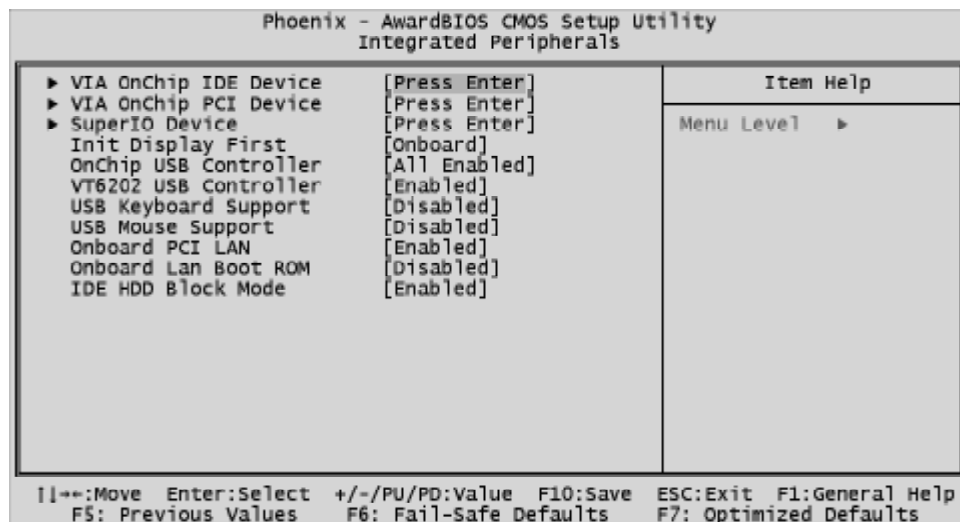

### VIA OnChip IDE Device

Options are in its sub-menu.

Press <Enter> to enter the sub-menu of detailed options.

#### **OnChip IDE Channel0**

The chipset contains a PCI IDE interface with support to two IDE channels. Select Enabled to activate the primary IDE interface; select Disabled to deactivate this interface

- The choice: Enabled or Disabled.

#### **OnChip IDE Channel1**

The chipset contains a PCI IDE interface with support to two IDE channels. Select Enabled to activate the secondary IDE interface; select Disabled to deactivate this interface

- The choice: Enabled or Disabled.

#### **IDE Prefetch Mode**

The onboard IDE drive interfaces support IDE prefetching for faster drive access. If you install a primary and/or secondary add-on IDE interface, set this field to Disabled if the interface does not support prefetching.

- The choice: Enabled or Disabled.

---

### **Primary/ Secondary / Master/ Slave PIO**

The four IDE PIO (Programmed Input/ Output) fields let you set a PIO mode (0-4) for each of the four IDE devices that the onboard IDE interface supports. Modes 0 through 4 provide successively increased performance. In Auto mode, the system automatically determines the best mode for each device.

- The choice: Auto, Mode 0, Mode 1, Mode 2, Mode 3, or Mode 4.

### **Primary/ Secondary / Master/ Slave UDMA**

Ultra DMA100 implementation is possible if your IDE hard drive supports it and the operating environment includes a DMA driver (Windows 95 OSR2 or a third-party IDE bus master driver). If both of your hard drive and your system software support Ultra DMA100, select Auto to enable BIOS support.

- The choice: Auto or Disabled.

### **VIA OnChip PCI Device**

Options are in its sub-menu.

Press <Enter> to enter the sub-menu of detailed options.

#### **VIA-3058 AC97 Audio**

This item allows you to control the onboard AC 97 audio.

- The choice: Auto or Disabled.

#### **VIA-3068 MC97 Modem**

This item allows you to control the onboard MC97 modem. Disable this item if you are going to install an external modem.

- The choice: Enabled or Disabled.

### **Super IO Device**

Options are in its sub-menu.

Press <Enter> to enter the sub-menu of detailed options.

#### **Onboard FDC Controller**

Select Enabled if your system has a floppy disk controller (FDC) installed on the system board and you want to use it. If you install add-on FDC or the system has no floppy drive, select Disabled in this field.

- The choice: Enabled or Disabled.

---

### **Onboard Serial Port1/ Port2**

Select an address and corresponding interrupt for the first and second serial ports.

- The choice: 3E8IRQ4, 2E8IRQ3, 3F8IRQ4, 2F8IRQ3, Auto, or Disabled.

### **UART Mode Select**

This item allows you to select which mode for the Onboard Serial Port 2.

- The choice: IrDA, ASKIR, SCR, or Normal.

### **UR2 Duplex Mode**

This item allows you to select the IR half/full duplex function.

- The choice: Full or Half.

### **Onboard Parallel Port**

This item allows you to determine onboard parallel port controller IO address setting.

- The choice: 378IRQ7, 278IRQ5, 3BCIRQ7, or Disabled.

### **Parallel Port Mode**

Select an operating mode for the onboard parallel (printer) port. Select Normal, Compatible, or SPP unless you are certain your hardware and software both support one of the other available modes.

- The choice: SPP, EPP, ECP, or ECP+EPP.

### **ECP Mode Use DMA**

Select a DMA channel for the parallel port for use during ECP mode.

- The choice: 1 or 3.

### **Game Port Address**

This item selects Game Port Address.

- The choice: Disabled, 201, or 209.

### **Midi Port Address**

This item selects Midi Port Address.

- The choice: Disabled, 330, or 300.

### **Midi Port IRQ**

This item selects Midi Port IRQ.

- The choice: 5 or 10.

---

### **Init Display First**

This item allows you to decide to activate PCI Slot or on-chip VGA first.

- The choice: PCI Slot or AGP.

### **OnChip USB Controller**

This should be enabled if your system has a USB installed on the system board and you want to use it. Even when on chip USB so equipped, if you add a higher performance controller, you will need to disable this feature.

- The Choice: All Disabled, All Enabled, 1&2 USB Port, 2&3 USB Port, 1&3 USB Port, 1 USB Port, 2 USB Port, or 3 USB Port.

### **USB Keyboard Support**

Select Enabled if your system contains a Universal Serial Bus (USB) controller and you have a USB keyboard.

- The Choice: Enabled or Disabled.

### **USB Mouse Support**

Select Enabled if your system contains a Universal Serial Bus (USB) controller and you have a USB Mouse.

- The Choice: Enabled or Disabled.

### **Onboard LAN Boot ROM**

This item allows you to enable or disable the onboard LAN Boot ROM function.

- The Choice: Enabled or Disabled.

### **IDE HDD Block Mode**

Block mode is also called block transfer, multiple commands, or multiple sector readwrite. If your IDE hard drive supports block mode (most new drives do), select Enabled for automatic detection of the optimal number of block readwrite per sector the drive can support.

- The choice: Enabled or Disabled

---

☞ **Power Management Setup**

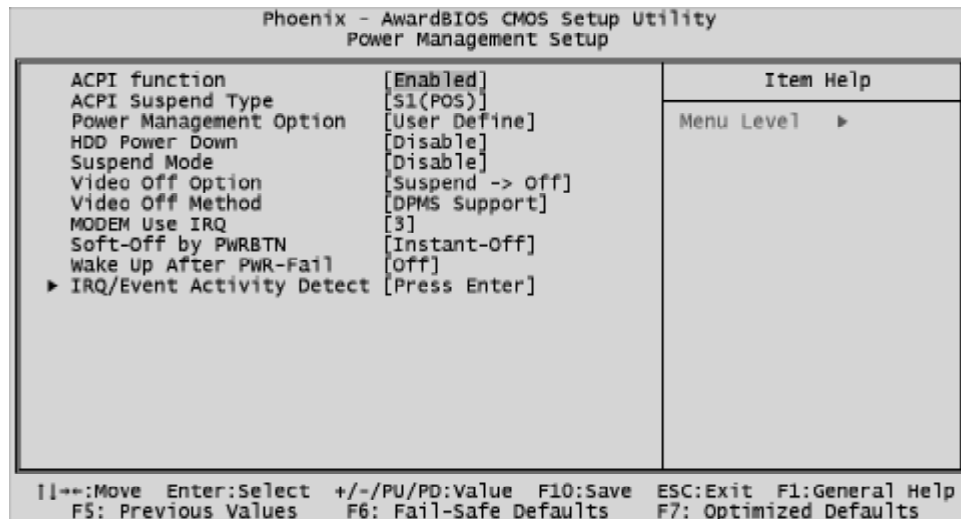

The Power Management Setup allows you to configure your system to most effectively saving energy while operating in a manner consistent with your own style of computer use.

**ACPI Function**

This item allows you to enable/disable the Advanced Configuration and Power Management (ACPI)

- The choice: Enabled or Disabled.

**ACPI Suspend Type**

This item allows you to select sleep state when suspend.

- The choice: S1(POS), or S3(STR).

**Power Management Option**

This category allows you to select the type (or degree) of power saving mode settings.

- Min Saving** Minimum power management.  
HDD Power Down = Allows you to set each mode individually.  
Suspend Mode = 1 hr.
- Max Saving** Maximum power management.  
HDD Power Down = Allows you to set each mode individually.  
Suspend Mode = 1 min.

---

**User Define** Allows you to set each mode individually.  
HDD Power Down = Disabled or in. ~ 15min.  
Suspend Mode = Disabled or 1 min ~ 1 hr.

- The choice: User Define, Min Saving, or Max Saving.

### **HDD Power Down**

When this item enabled and after the set up time of system inactivity, the hard disk drive will be powered down while all other devices remain active.

- The choice: Disabled or 1 Min ~ 15 Min.

### **Suspend Mode**

When this item enabled and after the set up time of system inactivity, all devices except the CPU will be shut off.

- The choice: Disabled, 1 Min, 2 Min, 4 Min, 6 Min, 8 Min, 10 Min, 20 Min, 30 Min, 40 Min, or 1 Hour.

### **Video Off Option**

When enabled, this feature allows the VGA adapter to operate in a power saving mode.

**Always On** Monitor will remain on during power saving mode.

**Suspend -> Off** Monitor is blanked when the system enters the Suspend mode.

- The choice: Always On or Suspend -> off.

### **Video Off Method**

This determines the manner in which the monitor is blanked.

**VH SYNC + Blank** This selection will cause the system to turn off the vertical and horizontal synchronization ports and write blanks to the video buffer.

**Blank Screen** This option writes blanks to the video buffer.

**DPMS Support** Initial display power management signaling.

- The choice: VH SYNC + Blank, Blank Screen, or DPMS Support.

### **MODEM Use IRQ**

This determines the IRQ which the MODEM can use.

- The choice: 3, 4, 5, 7, 9, 10, 11, or NA.

---

### **Soft-Off by PWRBTN**

Pressing the power button for more than 4 seconds forces the system to enter the Soft-Off state when the system has "hung".

- The choice: Instant-Off or Delay 4 Sec.

### **Wakeup After PWR-Fail**

Use this item to indicate what you expect to happen after a power failure has occurred.

- The choice: Auto, On, or Off.

### **IRQEvent Activity Detect**

Options are in its sub-menu.

Press <Enter> to enter the sub-menu of detailed options.

### **PS2KB Wakeup from S1 ~ S5**

Enables you to allow keyboard activity to awaken the system from power saving mode.

- The choice: Disable or Enabled.

### **VGA**

When this item enabled, you can set VGA to awaken the system.

- The choice: OFF or ON.

### **LPT & COM**

When LPT & COM stays On, any activity from one of the listed system peripheral devices or IRQs wakes up the system.

- The choice: NONE, LPT, COM, or LPTCOM.

### **HDD & FDD**

When HDD & FDD stays On, any activity from one of the listed system peripheral devices wakes up the system.

- The choice: OFF or ON.

### **PCI Master**

When PCI Master stays On, any activity from one of the listed system peripheral devices wakes up the system.

- The choice: OFF, or ON.

### **PCI & USB Device**

Use this item to enable modem activity fields become available and you can set the date(day of the month), hour, minute and second to turn on your system. When set to 0 (zero) for the day of the month, the



---

alarm will power on your system every day at the specified time.

- The choice: OFF, or ON.

#### **PowerOn by PCI Card**

This item enables/disables the power on function of PCI Card.

- The choice: Disabled or Enabled.

#### **Modem Ring Resume**

When this item enabled, any event occurring Modem Ring activity of LAN will awaken a system which has been powered down.

- The choice: Disabled or Enabled.

#### **RTC Alarm Resume**

When this item enabled, you can set the date and time at which the RTC (real-time clock) alarm awakens the system from Suspend mode.

- The choice: Disabled or Enabled.

#### **Data (of Month)**

This item selects the alarm date.

- Key in a DEC number: Min = 0, Max = 31.

#### **Resume Time (hh:mm:ss)**

This item selects the alarm Time.

[hh]

- Key in a DEC number: Min = 0, Max = 23.

[mmss]

- Key in a DEC number: Min = 0, Max = 59.

#### **IRQs Activity Monitoring**

##### **Primary INTR**

Press Enter to on/off the wake up ability of a specified IRQ.

- The choice: OFF, or ON.

In the following is a list of IRQ's, Interrupt ReQuests, which can be exempted much as the COM ports and LPT ports above can. When an IO device wants to gain the attention of the operating system, it signals this by causing an IRQ to occur. When the operating system is ready to respond to the request, it interrupts itself and performs the service.

When On mode exist, activity will neither prevent the system from going into a power management mode nor awaken it.

---

**IRQ3 (COM 2)**  
**IRQ4 (COM 1)**  
**IRQ5 (LPT 2)**  
**IRQ6 (Floppy Disk)**  
**IRQ7 (LPT 1)**  
**IRQ8 (RTC Alarm)**  
**IRQ9 (IRQ2 Redir)**  
**IRQ10 (Reserved)**  
**IRQ11 (Reserved)**  
**IRQ12 ( PS 2 Mouse )**  
**IRQ13 (Coprocessor)**  
**IRQ14 (Hard Disk)**  
**IRQ15 (Reserved)**

➤The choice: Disabled or Enabled.

---

☞ **PnP/PCI Configurations**

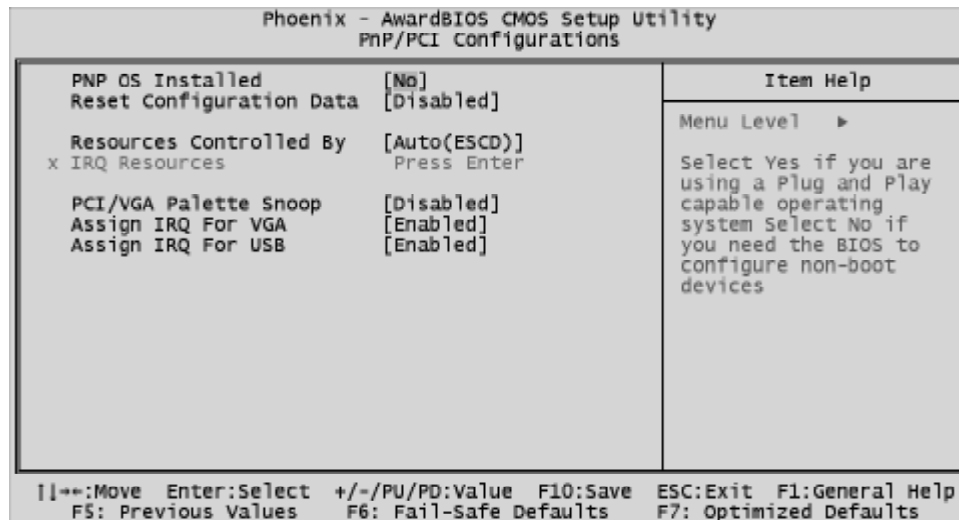

This section describes the configuration of PCI bus system. PCI or Personal Computer Interconnection is a system which allows IO devices to operate at the speed CPU itself keeps when CPU communicating with its own special components.

This section covers some very technical items, and it is strongly recommended that experienced users should make any changes to the default settings.

**PNP OS Installed**

This item allows you to determine PnP OS is installed or not.

- The choice: Yes or No.

**Reset Configuration Data**

Normally, you leave this field Disabled. Select Enabled to reset Extended System Configuration Data (ESCD) when you exit from Setup if you have installed a new device or software and the system reconfiguration has caused such a serious conflict that the operating system can not boot.

- The choice: Enabled or Disabled .

**Resource controlled By**

The Award Plug-and-Play BIOS has the capacity to automatically configure all of the boot and Plug-and-Play compatible devices. However, this capability means absolutely nothing unless you are using a Plug-and-Play operating system such as Windows 95. If you set this field to "manual" , choose specific resources by going into each of the

---

If you set this field to "manual" , choose specific resources by going into each of the sub-menu that follows this field (a sub-menu is preceded by a ">").

- The choice: Auto(ESCD) or Manual.

### **IRQ Resources**

When resources are controlled manually, assign each system interrupt a type, depending on the type of device using the interrupt.

#### **IRQ3/4/5/7/9/10/11/12/14/15 assigned**

This item allows you to determine the IRQ assigned to the ISA bus and is not available to any PCI slot. Legacy ISA for devices is compliant with the original PC AT bus specification; PCIISA PnP for devices is compliant with the Plug-and-Play standard whether designed for PCI or ISA bus architecture.

- The choice: PCI Device or Reserved.

### **PCI/ VGA Palette Snoop**

It determines whether the MPEG ISA/ VESA VGA Cards can work with PCI/ VGA or not. If you have MPEG ISA/ VESA VGA Cards and PCI/ VGA Card worked, Enable this field. Otherwise, please Disable it.

- The choice: Enabled or Disabled.

### **Assign IRQ For VGA**

This item allows the user to set VGA IRQ Routing table Enabled or Disabled.

- The choice: Enabled or Disabled.

### **Assign IRQ For USB**

This item allows the user the option to assign an IRQ to on-board USB controller.

Since the on-board controller is always enabled, if no IRQ is assigned to it, there will be a question mark report on the sytem device under Windows95/98.

- The choice: Enabled or Disabled.

---

☞ **PC Health Status**

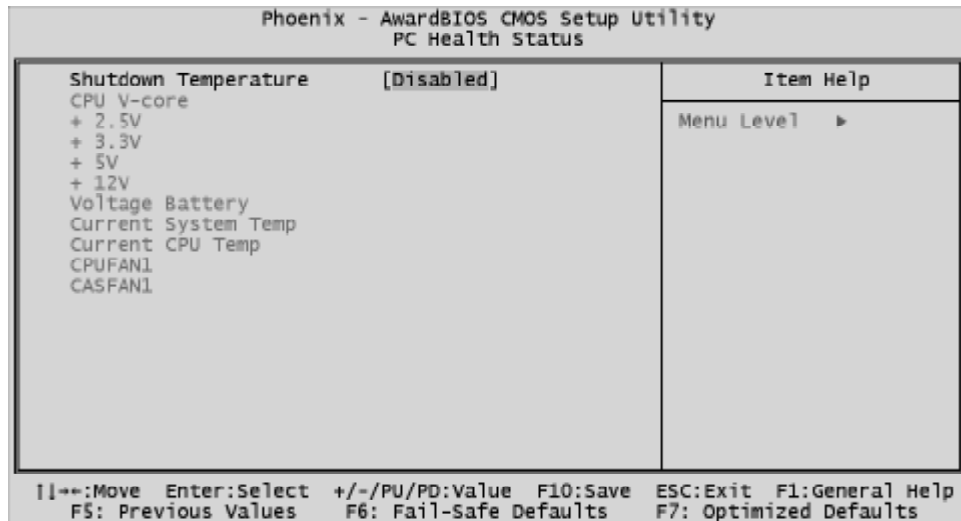

**Shutdown Temperature**

Enables you to set the maximum temperature the system can reach before powering down.

- The choice: Disabled, 60° C/140° F, 65° C/149° F, 70° C/158° F.

**System Component Characteristics**

These fields provide you with information about the systems current operating status. You cannot make changes to these fields.

The fields include

**CPU V-core**

**+ 2.5V**

**+ 3.3V**

**+ 5V**

**+ 12V**

**Voltage Battery**

**Current System Temp**

**Current CPU Temp**

**CPUFAN1**

**CASFAN 1**

---

☞ **FrequencyVoltage Control**

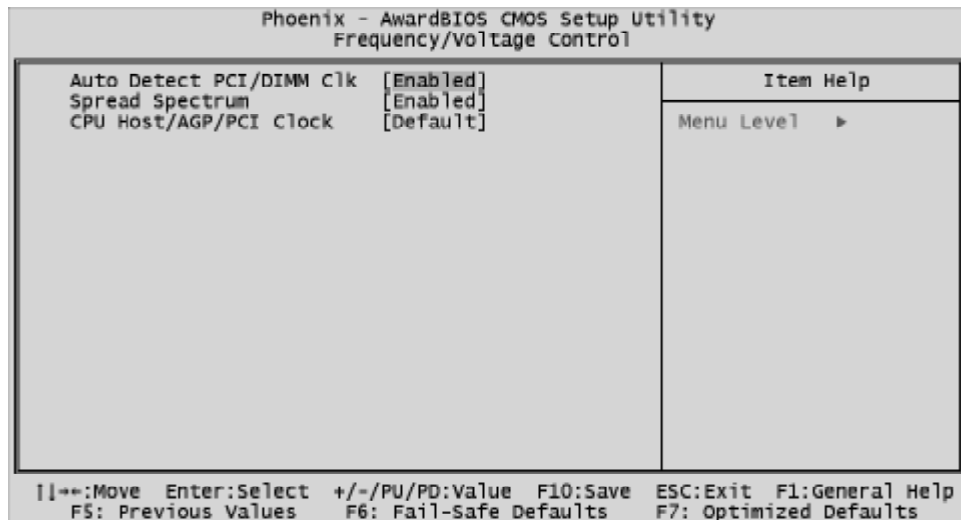

**Auto Detect PCI/DIMM Clk**

This item allows you to enable/disable auto detection PCI/DIMM Clock.

- The choice: Enabled or Disabled.

**Spread Spectrum**

This item allows you to enable/disable the spread spectrum modulation.

- The choice: Enabled or Disabled.

**CPU Host/AGP/PCI Clock**

This item is used for overclocking only.

---

☞ **Load Fail-Safe Defaults**

When you press <Enter> on this item, you will get a confirmation dialog box with a message similar to:

Load Fail-Safe Defaults (Y/N) ? N

Pressing 'Y' loads the BIOS default values for the most stable, minimal performance system operations.

☞ **Load Optimized Defaults**

When you press <Enter> on this item, you will get a confirmation dialog box with a message similar to:

Load Optimized Defaults (Y/N) ? N

Pressing 'Y' loads the default values that are factory-set for optimal performance system operation.

---

## ☞ Supervisor/ User Password Setting

You can set either supervisor or user password, or both of them. The differences between them are:

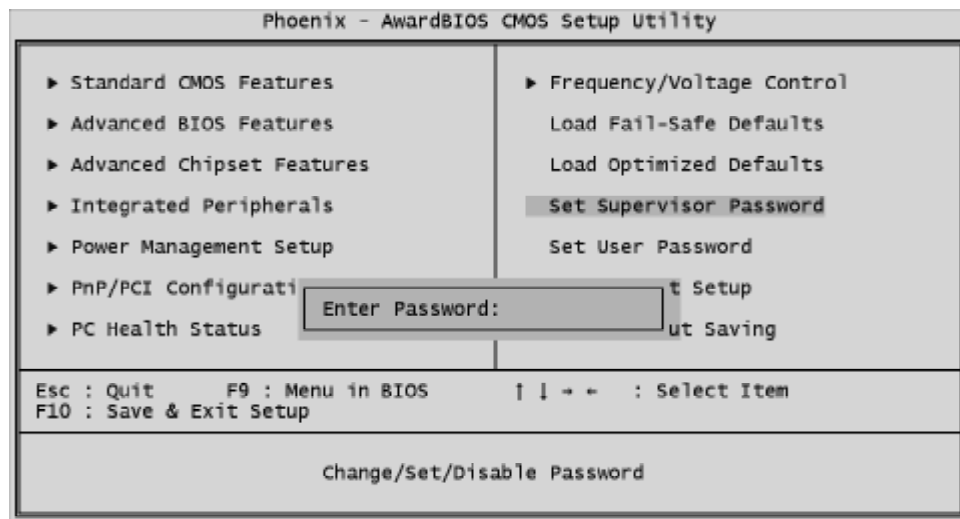

### Supervisor Password and User Password

The options on the Password screen menu make it possible to restrict access to the Setup program by enabling you to set passwords for two different access modes: Supervisor mode and User mode.

In general, Supervisor mode has full access to the Setup options, whereas User mode has restricted access to the options. By setting separate Supervisor and User password, a system supervisor can limit who can change critical Setup values.

### Enter Password

Type the password up to eight characters, and press <Enter>. The password typed now will clear any previously entered password from CMOS memory. You will be asked to confirm the password. Type the password again and press <Enter>. You may also press <Esc> to abort the selection and not enter a password.

To disable password, just press <Enter> when you are prompted to enter password. A message will confirm the password being disabled. Once the password is disabled, the system will boot and you can enter Setup freely.



---

### Password Disable

If you select System at Security Option of BIOS Features Setup Menu, you will be prompted in entering the password whenever the system is rebooted or you try to enter Setup. If you select Setup at Security Option of BIOS Features Setup Menu, you will be prompted when you try to enter Setup.

**Warning:** Retain a record of your password in a safe place. If you forget the password, the way to access the system is to clear CMOS, please refer to "Clear CMOS" on page 28.

### Save & Exit Setup

Pressing <Enter> on this item asks for confirmation:

Save to CMOS and EXIT (Y/N)? Y

Pressing "Y" stores the selections made in the menus of CMOS - a special section of memory that stays on after you turn your system off. The next time you boot your computer, the BIOS configures your system according to the Setup selections stored in CMOS. After saving the values the system is restarted again.

### Exit Without Saving

Pressing <Enter> on this item asks for confirmation:

Quit without saving (Y/N)? Y

This allows you to exit from Setup without storing in CMOS any change. The previous selections remain in effect. This exits from the Setup utility and restarts your computer.